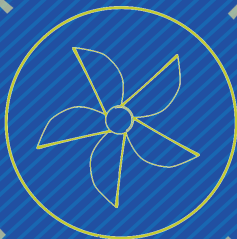


2022

# CIRCUIT RULEBOOK

DECK PLAN



**UIM**   
UNION INTERNATIONALE MOTONAUTIQUE

1922 – 2022



#### Formula 1



Jonas  
ANDERSSON  
Sweden

#### Formula 2



Rashed  
AL QEMZI  
UAE

#### Formula 4



Sami  
REINIKAINEN  
Finland

#### Formula 500



Erko  
AABRAMS  
Estonia

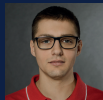
#### GT30

H.H. Sheikh Sultan Bin Khalifa Al Nahyan  
Abu Dhabi Trophy



Laura  
LAKOVICA LAKOVICA  
Latvia

#### OSY400



Cezary  
STRUMNIK  
Poland

#### Formula 125



Sanna  
AASLAV-KAASIK  
Estonia

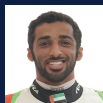
#### Formula 250 & Formula 350



Peter  
BODOR  
Hungary



### Endurance Class S2



Rashed  
AL QEMZI  
UAE

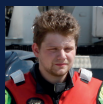


Thani  
AL QEMZI  
UAE



Mansoor  
AL MANSOORI  
UAE

### Endurance Class S3



Quentin  
DAILLY  
France



Jeremy  
BRISSET  
France



Romuald  
KAUFFMANN  
France

### Formula Future Class 1



Akim  
LOGOSHA  
Russia

### Formula Future Class 2



Konstantin  
DAVIDOV  
Russia

### Formula Future Class 3



Magomedrasul  
ALICHUEV  
Russia

### Formula Future Class 4



Artem  
SHUMKIN  
Russia

### Formula Future Class 5



Toms  
BUNDZINSKIS  
Latvia



River Marathon – OB2000 (Colombia)

---



Sixto  
VERGARA



Ruben  
GUERRERO

River Marathon – OB3000 (Colombia)

---



Santiago  
ZULUAGA



Lebos R.  
CHAGURI

River Marathon - Overall (Colombia / Mexico)

---



Luis Carlos  
CELIS



Uriel  
ALEMAN





#### Formula 4



Stefan  
ARAND  
Estonia

#### Formula 500



Giuseppe  
ROSSI  
Italy

#### Formula 125



Marek  
PEEBA  
Estonia

#### Formula 250 & Formula 350



Massimiliano  
CREMONA  
Italy

#### Formula 700



Marian  
JUNG  
Slovakia

#### GT15



Hendrik  
ARULA  
Estonia

#### GT30



Laura  
LAKOVICA  
LAKOVICA  
Latvia

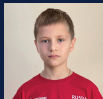
#### OSY400



Janis  
BADAUKIS  
Latvia



#### Formula Future Class 1



Akim  
LOGOSHA  
Russia

#### Formula Future Class 2



Dovydas  
GEDRIMAS  
Lithuania

#### Formula Future Class 3



Magomedrasul  
ALICHUEV  
Russia

#### Formula Future Class 4



Monika  
NOWAK  
Poland

#### Formula Future Class 5



Jakub  
SKRZYPEK  
Poland



1922 – 2022

# **CIRCUIT RULES 2022**

**PUBLISHED ON 22/12/21**

## TABLE OF CONTENTS

<b>CIRCUIT RULES 2022</b> .....	<b>7</b>
<b>101 - UIM EVENT SANCTIONS AND THE SPORTS CALENDAR</b> .....	<b>28</b>
101.01 - EVENT SANCTION REQUIREMENTS AND FEES .....	28
101.02 - OTHER MEETINGS .....	29
101.03 - DEADLINE DATES .....	29
101.04 - LATE REQUEST, CHANGE OF DATE AND CANCELLATION .....	29
<b>103 - RACES RECOGNISED BY THE UIM</b> .....	<b>30</b>
<b>104 - NON APPROVED RACES</b> .....	<b>30</b>
104.01 - SPECIAL LICENCES .....	31
<b>105 - TITLED INTERNATIONAL EVENTS</b> .....	<b>31</b>
<b>106 - INTERNATIONAL CHAMPIONSHIPS, WORLD AND CONTINENTAL CUPS</b> .....	<b>32</b>
106.01- GENERAL RULES .....	32
106.02 - WATER REGISTRATION.....	32
<b>107 - WORLD CHAMPIONSHIP</b> .....	<b>35</b>
<b>108 - CONTINENTAL AND WORLD CHAMPIONSHIPS</b> .....	<b>35</b>
108.01 - NUMBER OF CHAMPIONSHIPS.....	35
<b>108.02 - EUROPEAN CHAMPIONSHIP SERIES</b> .....	<b>36</b>
<b>108.03 - WORLD CHAMPIONSHIP WITH HYDRO GP</b> .....	<b>36</b>
108.04 - ENTRIES .....	37
108.05 - HEATS AND LENGTH .....	37
108.06 - RESULTS .....	38
<b>109 - RACING LICENCES</b> .....	<b>38</b>
109.01 - COMPULSORY LICENCE .....	38
109.02 – REGISTRATION .....	39
109.03 - VALIDITY OF LICENCES .....	39
109.04 - COST OF LICENCE .....	40
109.05 - EXAMINATION OF LICENCES .....	40
109.06 - CANCELLATION OF LICENCE .....	40
109.07 – PSEUDONYM.....	40
109.08 - SUPER-LICENCE ENDORSEMENT FOR WORLD FORMULA SERIES RACING .....	40
109.09 - MEDICAL EVALUATION SHEET .....	40
109.10 - GENERAL OBJECTIVE EXAMINATION .....	41
109.11 - ADDITIONAL ITEMS FOR SUPER-LICENCE .....	42
109.12 - ELECTION OF DRIVERS REPRESENTATIVE .....	42
109.13 – MODEL APPLICATION FORM FOR A LICENCE .....	43
109.14 - MODEL OF LICENCE .....	43
<b>110 – UIM COMMISSIONER</b> .....	<b>43</b>
<b>200 - RACE ORGANISATION</b> .....	<b>48</b>
200.01 – GENERAL .....	48
200.02 - INTERPRETATION OF THE RULES.....	48
<b>201 - ORGANISING BODIES</b> .....	<b>48</b>
201.01 - RACE COMMITTEE .....	48
201.02 - INTERNATIONAL OFFICERS LISTS .....	49
201.03 - THE OFFICER OF THE DAY (O.O.D.).....	49

201.04 - THE DEPUTY OFFICER OF THE DAY (D.O.O.D.) .....	49
201.05 - THE RACE SECRETARY .....	50
201.06 - DUTIES OF THE RACE OFFICIALS .....	50
201.07 - THE TECHNICAL OFFICERS .....	50
201.08 - THE BUOY AND COURSE OFFICERS .....	50
201.09 - THE TIMEKEEPERS AND STARTER .....	50
<b>202 - ADVANCE PROGRAMME .....</b>	<b>51</b>
202.01 - FORWARDING DATE .....	51
202.02 - INFORMATION IN ADVANCE PROGRAMME .....	51
202.03 - ADDITIONAL REQUIREMENTS .....	52
<b>203 - ENTRIES .....</b>	<b>52</b>
203.01 - RATIFICATION .....	52
203.02 - ADMISSION .....	52
203.03 - ENTRY FEE .....	53
203.04 - MINIMUM AGE .....	53
203.05 - NATIONALITY .....	53
203.06 - PUBLICITY ON THE BOATS .....	53
<b>204 - RACE INSTRUCTIONS .....</b>	<b>53</b>
204.01 - ORGANISING COMMITTEE MEETING .....	53
204.02 - DRIVERS MEETING .....	54
<b>205 - SAFETY RULES .....</b>	<b>55</b>
205.01 - ANNUAL MEDICAL EXAMINATION .....	55
205.02 - MEDICAL EXAMINATION AT EVENT .....	56
205.05 - IMMERSION TRAINING .....	56
205.06 – RACING VEST .....	57
205.07 - PROTECTING HELMET (except Formula Future and Solar Racing) .....	57
205.08 - SAFETY BOATS .....	58
205.09 - INSURANCE .....	59
205.10 - TECHNICAL PROTECTION .....	59
205.11 - CLOTHING PROTECTION (except Formula Future and Solar Racing) .....	60
205.12 - LIFTING OF RACEBOATS .....	60
205.13 - TESTING .....	60
205.14 - ACCIDENT REVIEW BOARD .....	60
<b>206 - NATIONALITY AND RACE NUMBERS .....</b>	<b>60</b>
206.01- NATIONAL FLAG .....	60
206.02 - NUMBERS .....	60
206.03 - LOSS OF RACE NUMBER .....	61
206.04 - UIM STICKERS .....	61
<b>207 - DISCLAIMER .....</b>	<b>61</b>
<b>208 – HAND SIGNALS .....</b>	<b>62</b>
<b>209 - POSTING OF THE RESULTS .....</b>	<b>62</b>
<b>210 – PRIZES .....</b>	<b>63</b>
210.01 .....	63
210.02 .....	63
<b>211 - REPORTS .....</b>	<b>63</b>
211.01 .....	63
211.02 .....	63
211.03 .....	63

<b>300 - RULES FOR CIRCUIT RACES</b> .....	<b>64</b>
300.01 - DEFINITIONS .....	64
<b>301 - TIMING</b> .....	<b>64</b>
<b>302 - CIRCUIT</b> .....	<b>65</b>
302.01 .....	65
302.02 - RACE CONTROL .....	65
<b>303 - MARKS OF THE COURSE</b> .....	<b>65</b>
303.01 - DEFINITIONS .....	65
303.02 - TURNING BUOYS.....	66
<b>304 - SIGNALS FROM THE SHORE</b> .....	<b>66</b>
304.01 - CALL SIGNALS .....	66
304.02 - FLAG SIGNALS.....	66
<b>305 - THE START</b> .....	<b>67</b>
305.01 .....	67
305.02 .....	67
305.03 .....	67
305.04 - QUALIFYING .....	67
<b>306 - FLYING START WITH CLOCK, DISCS AND GUN</b> .....	<b>68</b>
306.01 - PLACE OF THE CLOCK .....	68
306.02 - DISCS.....	68
306.03 - GUN.....	68
306.04 - STARTING LINE.....	69
306.05 - SAFETY ZONE.....	69
306.06 - BEFORE THE START .....	69
306.07 - THE START .....	69
306.08 - APPROACHES TO THE STARTING LINE.....	69
306.09 - BOAT STARTING BEFORE TIME.....	70
<b>307 - DEAD ENGINE START FROM A QUAY, A JETTY OR ABEACH</b> .....	<b>70</b>
307.01 .....	70
307.02 .....	70
307.03 .....	71
307.04 .....	71
307.05 - MATCH RACE RULES.....	71
<b>308 - RACE CANCELLED</b> .....	<b>74</b>
<b>309 - RACE POSTPONED</b> .....	<b>74</b>
309.01 .....	74
309.02 .....	74
309.03 .....	74
<b>310 - RACE SHORTENED</b> .....	<b>75</b>
<b>311 - RACE STOPPED AND RE-STARTS</b> .....	<b>75</b>
311.01 - GENERALLY .....	75
311.02 - RACING IN HEATS .....	75
311.03 - SINGLE HEAT RACING .....	76
<b>312 - RULES OF THE ROAD</b> .....	<b>76</b>
312.01 .....	76
312.02 - OVERLAP.....	76
312.03 .....	77
312.04 .....	77
312.05 .....	77

312.06	77
312.07	77
312.08 - OVERTAKING	77
312.09 - EMERGENCY INTERRUPTION	77
312.10 - DRIVING IN WRONG DIRECTION	77
312.11 - PASSING MARKS	77
312.12 - ALTERING COURSE	77
312.13 - LAPPED DRIVER	77
<b>313 - ROUNDING AND FOULING MARKS</b>	<b>78</b>
313.01	78
313.02	78
<b>314 - FOULING COMPETING BOATS</b>	<b>78</b>
<b>315 - MEANS OF PROPULSION</b>	<b>78</b>
<b>316 - FINISHING A RACE</b>	<b>78</b>
316.01 - THE FINISH	78
316.02	79
316.03	79
<b>317 - SCORING SYSTEM</b>	<b>79</b>
317.01	79
317.02	80
317.03	80
317.04	80
317.05	80
317.06	80
317.07	80
317.08	80
<b>318 - DEAD-HEAT</b>	<b>81</b>
318.01	81
318.02	81
<b>400 - JURISDICTION</b>	<b>82</b>
401.01 - DEFINITIONS	82
401.02	82
<b>402 - JUDICIAL BODIES</b>	<b>82</b>
402.01 - THE INTERNATIONAL JURY	82
402.02 - INTERESTED PARTIES	82
<b>403 - PROTEST PROCEDURES</b>	<b>82</b>
403.01 - VALIDITY OF PROTESTS	82
403.02 - PROTEST FEE	83
403.03 - RIGHT OF PROTEST	83
403.04 - TIME OF LODGING A PROTEST/ PROTEST PERIOD	83
403.05 - JUDGEMENT	83
403.06 - NOTIFICATION OF DECISION	84
403.07 - AVAILABILITY OF DOCUMENTS	84
<b>404 - HEARING OF THE PROTEST</b>	<b>84</b>
404.01 - RIGHT TO A HEARING	84
404.02 - EVIDENCE	84
404.03 - THE HEARING PROCEDURE	84
<b>405 - THE APPEALS PROCEDURE</b>	<b>85</b>

405.01 - UIM INTERNATIONAL COURT OF APPEAL (ICA).....	85
405.02 - INTERESTED PARTIES.....	85
405.03 - RIGHT OF APPEAL.....	85
405.04 - NOTICE OF INTENTION TO APPEAL.....	85
405.05 - TIME LIMIT.....	86
405.06 - LODGING OF AN APPEAL.....	86
405.07 - NOTIFICATION OF THE PARTIES OF THE APPEAL.....	86
405.08 - TIME LIMIT FOR DECISIONS ON APPEALS.....	86
405.09 - UIM INTERNATIONAL COURT OF APPEAL (ICA) DECISIONS.....	86
405.10 - COSTS.....	86
<b>406 - PENALTIES.....</b>	<b>87</b>
406.01 - GENERAL.....	87
406.02 - DEADLINES FOR PENALIZING.....	87
406.03 - UNACCEPTABLE BEHAVIOUR.....	87
406.04 - REPRIMAND.....	87
406.05 - YELLOW / RED / BLUE CARDS.....	88
406.06 - DISQUALIFICATION.....	89
406.07 - TEMPORARY SUSPENSION.....	89
406.08 - PROLONGED SUSPENSION.....	89
406.09 - EXCLUSION.....	89
<b>407 - PRIORITY OF THESE RULES.....</b>	<b>89</b>
<b>408 - POWERBOAT PROTEST FORM.....</b>	<b>90</b>
<b>409 - ARBITRATION.....</b>	<b>91</b>
409.01 - GENERAL.....	91
409.02 - PARTIES OF THE ARBITRATION PROCEDURE.....	91
409.03 - DEADLINES FOR ARBITRATION.....	91
409.04 - FEE AND COSTS.....	91
409.05 - FURTHER PROCEDURE.....	91
<b>500 - INTERNATIONAL SERIES AND CLASSES.....</b>	<b>92</b>
500.01 - DEFINITIONS.....	92
500.02 - INTERNATIONAL SERIES AND CLASSES.....	92
500.03 - RECOGNISED SERIES AND CLASSES.....	92
500.04 - ENTRY LEVEL RACING CLASSES.....	92
<b>501 - MEASUREMENT CERTIFICATE.....</b>	<b>92</b>
501.01.....	93
501.02.....	93
501.03.....	93
501.04.....	93
501.05.....	94
501.06.....	94
501.07.....	94
501.08.....	94
501.09.....	95
501.10.....	95
501.11.....	95
<b>502 - REPAIRS.....</b>	<b>95</b>
<b>503 - INSPECTIONS.....</b>	<b>96</b>



503.01.1 - GENERAL .....	96
503.01.2 - PENALTIES .....	96
503.01.3 - PERSONS ALLOWED TO ATTEND THE INSPECTION .....	96
503.02 - PRE-RACE INSPECTION .....	97
503.03 - INSPECTION AT RACE .....	98
503.04 - AFTER RACE INSPECTION .....	98
<b>504 - EQUIPMENT - PEOPLE ABOARD-MOTORS .....</b>	<b>99</b>
504.01 .....	99
504.02 - WINDSCREEN .....	100
504.03 - AUTOMATIC THROTTLE SHUT-OFF .....	100
504.04 .....	100
504.05 .....	100
504.06 .....	101
504.07 - PISTON MOTORS .....	101
504.08 - ROTARY MOTORS .....	101
504.09 - SUPERCHARGING .....	101
504.10 - FINS .....	101
504.11 - ELECTRICAL ISOLATION .....	101
504.12 - BALLAST .....	101
504.13 - PROPELLERS WITH EXHAUST TUBE .....	102
504.14 AUTO PILOTS .....	102
<b>505 - NOISE REDUCTIONS .....</b>	<b>103</b>
505.01 .....	103
505.02 .....	103
505.03 .....	103
<b>506 - ENGINE HOMOLOGATION .....</b>	<b>104</b>
506.01 - RESPONSIBILITY .....	104
506.02 - PROCESSES .....	104
506.02.01 - PROCESS #1 .....	104
506.02.02 - PROCESS #2 .....	104
506.03 - HOMOLOGATION APPLICATION - PROCESS#1 .....	104
506.04 - MINIMUM PRODUCTION QUANTITIES .....	104
506.05 - DEADLINE FOR APPLICATION .....	105
506.06 - APPROVAL OF APPLICATION - PROCESS#1 .....	105
506.07 - INSPECTION VERIFICATION PROCEDURE .....	105
506.08 - TERM OF HOMOLOGATION .....	105
506.09 - ANNOTATION OF VALID CATEGORIES .....	105
506.10 - HOMOLOGATION FILE COPIES .....	105
506.11 - RUNNING PRODUCTION CHANGES .....	106
506.12 - EXTENSION OF VALIDITY .....	106
<b>508 - FUEL .....</b>	<b>106</b>
508.01 .....	106
508.02 - SPORTS ENGINE FUEL (S. T. P. E. - OSY400 - F1000 - F2 - F4 AND O CLASSES) .....	106
508.03 - RACING ENGINE FUEL (R CLASSES) .....	107
508.04 - DIESEL ENGINE FUEL .....	107
508.05 - ALCOHOL BASED FUEL .....	107

508.06 - ADDITIVES .....	107
508.07 - RANDOM TESTING OF COMPETITORS' FUEL .....	107
508.08 - TESTING PROCEDURES .....	108
508.09 - DISQUALIFICATIONS, PROTESTS AND APPEALS .....	108
508.10 - REFUELLING .....	108
508.11 - STARTING AIDS .....	108
<b>509 - REINFORCED COCKPITS .....</b>	<b>109</b>
509.01 .....	110
509.02 - PICKLE-FORKS .....	111
509.03 .....	113
509.04 .....	114
509.05 .....	114
509.06 .....	115
509.07 .....	115
509.08 .....	116
509.09 .....	116
509.10 .....	116
509.11 .....	116
509.12 - MOTOR SHUT OFF SWITCH .....	116
509.13 - VISIBILITY IN COCKPITS .....	116
509.14 .....	117
509.15 .....	117
509.16 .....	117
509.17 .....	118
509.18 .....	118
509.19 .....	123
509.20 - AIR SUPPLY .....	124
509.21 - CRASH BOXES .....	125
509.22 - REPAIRS .....	125
509.23 - HULL IDENTIFICATION NUMBER (HIN) .....	125
509.24 - GUIDELINES FOR INSPECTION AIRBAG SYSTEM .....	125
<b>510 - RACING INBOARDS (R) .....</b>	<b>126</b>
<b>511 - CLASSES .....</b>	<b>126</b>
<b>512 - HULL .....</b>	<b>126</b>
512.01 .....	126
512.02 .....	126
512.03 - MINIMUM DIMENSIONS .....	126
<b>513 - MACHINERY .....</b>	<b>126</b>
513.01 .....	126
513.02 .....	127
513.03 .....	127
513.04 .....	127
513.05 .....	127
<b>514 - FUEL .....</b>	<b>127</b>
<b>515 - RACING INBOARD - HISTORIC (H.R.) - FORMULA R 1000 .....</b>	<b>127</b>
<b>516 - CLASSES .....</b>	<b>127</b>
<b>517 - HULL .....</b>	<b>128</b>

517.01 .....	128
517.02 .....	128
<b>518 - MACHINERY .....</b>	<b>128</b>
518.01 .....	128
518.02 .....	128
<b>519 - FUEL.....</b>	<b>128</b>
<b>520 - RACING OUTBOARDS (F &amp; O) .....</b>	<b>129</b>
<b>521 - CLASSES.....</b>	<b>129</b>
<b>522 - HULL .....</b>	<b>129</b>
522.01 .....	129
522.02 .....	130
522.03 SPONSON FIN FOR HYDROPLANE TYPE BOATS.....	134
522.04 - MINIMUM DIMENSIONS.....	135
<b>523 - MACHINERY .....</b>	<b>135</b>
523.01 .....	135
523.02 .....	135
523.03 .....	136
523.04 .....	136
523.05 .....	136
523.06 .....	136
<b>524 - FUEL.....</b>	<b>136</b>
<b>525 - CLASS OSY 400 .....</b>	<b>136</b>
525.1 - HULL.....	136
525.2 - MACHINERY .....	137
525.3 - FUEL.....	138
525.4 .....	138
525.5 SKEG .....	138
<b>530 - SPORT INBOARDS (E) .....</b>	<b>140</b>
<b>531 - CLASSES .....</b>	<b>140</b>
<b>532 - HULL .....</b>	<b>140</b>
532.01 .....	140
532.02 .....	140
532.03 .....	141
532.04 .....	141
532.12 - MINIMUM DIMENSIONS.....	141
<b>533 - MACHINERY .....</b>	<b>141</b>
533.01 .....	141
533.02 .....	141
533.03 .....	141
533.04 .....	142
533.05 .....	142
533.06 .....	142
533.07 .....	142
533.08 .....	142
533.09 .....	142
533.10 - SOLE MODIFICATIONS ALLOWED .....	142
533.11 - ELECTRIC STARTER .....	143
533.12 TRANSMISSION .....	143

<b>534 - FUEL</b> .....	<b>143</b>
<b>540 - SPORT OUTBOARDS (S)</b> .....	<b>143</b>
<b>541 - CLASSES</b> .....	<b>143</b>
541.01 - LOW EMISSION ENGINES.....	144
<b>542 - HULL</b> .....	<b>144</b>
542.01 .....	144
542.02 .....	144
542.03 .....	144
542.05 .....	144
542.12 - MINIMUM DIMENSIONS.....	144
<b>543 - MACHINERY</b> .....	<b>145</b>
543.01 .....	145
543.02 .....	145
543.03 .....	145
543.04 .....	145
543.05 .....	145
543.06 .....	146
543.07 .....	146
543.08 .....	146
543.09 - SOLE MODIFICATIONS ALLOWED .....	146
543.10- MODIFICATIONS NOT PERMITTED ON LOW EMISSION ENGINES .....	147
<b>544 - FUEL</b> .....	<b>147</b>
<b>545 - SPORTS OUTBOARDS - HISTORIC (HS)</b> .....	<b>147</b>
545.01 - CLASSES .....	147
545.02 - HULL.....	147
545.03 - MACHINERY .....	148
545.04 - FUEL.....	148
545.05- RACE FORMAT .....	148
<b>550 - MONOHULL OUTBOARDS (T)</b> .....	<b>148</b>
550.1 - CLASSES .....	148
550.2 - HULL.....	148
550.3 .....	149
550.4 .....	149
550.5 - MINIMUM DIMENSIONS.....	150
550.6 - MACHINERY .....	150
<b>560 - P750 CLASS</b> .....	<b>154</b>
560.01- TITLES / TEAMS .....	154
560.02 - O.O.D (OFFICER OF THE DAY).....	155
560.03 - PRIZE PRESENTATION.....	155
560.04 - MINIMUM BOATS NUMBERS AND NATIONAL AUTHORITIES .....	155
560.05 - LICENCE DETAILS .....	155
560.06 - FINAL INSPECTION .....	156
560.07 - TEAMS .....	156
560.08 - MINIMUM AGE .....	156
560.09 - BEHAVIOUR.....	156
560.10- PROTESTS .....	156
560.11 - PROTEST FEE .....	156

560.12 - ALCOHOL/DRUGS.....	157
560.13 - INSURANCES.....	157
560.14 - PENALTIES/YELLOW/RED CARDS/BLUE CARDS.....	157
560.15 - DRIVERS BRIEFING.....	157
560.16 - SAFETY EQUIPMENT.....	157
<b>561 - CLASSES/HULLS.....</b>	<b>158</b>
561.00 - DISCIPLINES.....	158
561.01 - HULLS LENGTHS AND WEIGHTS.....	158
561.02 - HULL DESIGN.....	158
561.04 - DEFINITION OF HULLS.....	160
561.05 - MODIFICATION ABOVE THE WATERLINE.....	161
561.06 - SPLASH PLATE.....	161
561.07 - MODIFICATION BELOW THE WATERLINE.....	161
561.08 - WINDOWS.....	161
561.09 - RACE NUMBERS.....	161
561.10 - RIGHTING ROPES & BOWLINE.....	161
561.11 - SPONSORS.....	161
<b>562 - MACHINERY.....</b>	<b>162</b>
562.07 - IRREPAIRABLE DAMAGE/DAMAGED HULL/ENGINE/LOWER UNIT.....	162
562.08 - GEARBOX.....	163
<b>563 - MODIFICATIONS.....</b>	<b>163</b>
563.34 - FUEL.....	167
563.35 - FUEL DETAILS AVAILABLE:.....	167
563.36 - OIL.....	167
563.37 - FUEL TANKS.....	167
563.38 - FUEL MIX.....	167
<b>564A - TECHNICAL.....</b>	<b>167</b>
<b>564B - RACING REGULATIONS AND RULES.....</b>	<b>171</b>
564B.30 GRID POSITIONS FOR INTERNATIONAL EVENTS.....	178
564B.31 - POINTS & GUIDELINE TO ELIMINATING HEATS.....	179
564B.32 - DANGEROUS DRIVING.....	179
564B.33 - OVERLAP.....	180
564B.34 - OVERTAKING.....	180
564B.35 - PASSING MARKS.....	180
<b>564C - M SHAPE / SURF DISCIPLINE.....</b>	<b>181</b>
564C.01 - START M SHAPE (SURF).....	181
564C.02 - START LINE.....	182
564C.03 - RESTARTS (SEE ALSO WET DRIVER RULE 564B.02).....	183
564C.04 - RE-RUN.....	183
<b>564D - CIRCUIT DISCIPLINE.....</b>	<b>183</b>
564D.01 - START: CIRCUIT.....	183
564D.02 - FLAG OR JETTY START FROM PONTOON. CIRCUIT.....	184
564D.03 - EQUALISER LAPS.....	184
564D.04 - RESTARTS.....	184
564D.05 - RE-RUN.....	184
<b>564E - LONGHAUL DISCIPLINE.....</b>	<b>184</b>
564E.01 - TIMES.....	184

564E.02 - LONGHAUL STARTS .....	184
564E.03 - SAFETY EQUIPMENT .....	185
564E.04 - BEACH STOPS .....	186
<b>565 - RIGID INFLATABLE BOATS (PR) (PF) .....</b>	<b>187</b>
<b>566 - CLASSES .....</b>	<b>187</b>
<b>567 - HULL (PR CLASSES ONLY) .....</b>	<b>188</b>
567.01 .....	188
567.02 .....	188
567.03 .....	188
567.04 .....	189
567.05 .....	189
567.06 - MINIMUM DIMENSIONS .....	189
<b>568 - MACHINERY .....</b>	<b>189</b>
568.01 .....	189
568.02 .....	190
568.03 .....	190
568.04 .....	190
568.05 .....	190
568.10 - SOLE MODIFICATIONS ALLOWED .....	190
<b>569 - FUEL .....</b>	<b>191</b>
<b>570 - BOATS WITH DIESEL MOTORS (D) .....</b>	<b>191</b>
<b>571 - CLASSES .....</b>	<b>191</b>
571.01 .....	191
571.02 .....	191
571.03 .....	191
<b>572 - HULL .....</b>	<b>191</b>
572.01 .....	191
<b>573 - MACHINERY .....</b>	<b>192</b>
573.01 .....	192
573.02 .....	192
573.03 .....	192
573.04 .....	192
573.05 .....	192
573.06 .....	192
<b>574 - FUEL .....</b>	<b>192</b>
<b>580 - TURBO JETS AND ROCKET PROPELLED BOATS (TR) .....</b>	<b>192</b>
<b>581 - CLASSES .....</b>	<b>192</b>
581.01 .....	192
581.02 .....	192
581.03 .....	193
<b>582 - HULL .....</b>	<b>193</b>
582.01 .....	193
582.02 .....	193
582.03 .....	193
582.04 .....	193
582.05 .....	193
582.06 .....	193
<b>583 - MACHINERY .....</b>	<b>193</b>
583.01 .....	193

583.02 .....	193
583.03 .....	193
<b>584 - FUEL.....</b>	<b>194</b>
584.01 .....	194
<b>590 - BOATS WITH AERIAL PROPELLER (A) .....</b>	<b>194</b>
<b>591 - CLASSES.....</b>	<b>194</b>
591.01 .....	194
<b>592 - HULL .....</b>	<b>194</b>
592.01 .....	194
592.02 .....	194
592.03 .....	194
592.04 .....	194
592.05 .....	194
<b>593 - MACHINERY .....</b>	<b>194</b>
593.01 .....	194
<b>594 - FUEL.....</b>	<b>194</b>
<b>595 - ELECTRIC POWERED BOATS (E).....</b>	<b>195</b>
595.01 - CLASSES .....	195
595.02 - HULL .....	195
595.03 - MACHINERY .....	195
595.04 - ELECTRIC BOAT SAFETY RULES .....	196
<b>596 - ELECTRIC MONOHULL OUTBOARDS (ET).....</b>	<b>197</b>
596.01 - CLASSES .....	197
596.02 - HULL .....	197
596.03 - MACHINERY .....	197
596.04 - ELECTRIC SAFETY .....	197
<b>597 - ELECTRIC HYDRO OUTBOARDS (EH) .....</b>	<b>197</b>
597.01 - CLASSES .....	197
597.02 - HULL .....	198
597.03 - MACHINERY .....	198
597.04 - ELECTRIC SAFETY .....	198
<b>600 - RECORDS AND PERFORMANCES .....</b>	<b>199</b>
600.01 - GENERAL.....	199
600.02 .....	199
600.03 .....	199
600.04 .....	199
600.05 - ELECTRIC BOAT RECORDS RULES .....	200
<b>601 - CLASSES ELIGIBLE FOR RECORDS .....</b>	<b>200</b>
601.01 .....	200
601.02 .....	200
601.03 - FROZEN RECORDS .....	201
601.04 - QUALIFICATION .....	201
<b>602 - DEFINITION OF UNITS.....</b>	<b>201</b>
602.01 - TIME, DISTANCE AND SPEEDS .....	201
602.02 - STATUTE MILE, NAUTICAL MILE AND KILOMETRE.....	201
<b>604 - BASES.....</b>	<b>202</b>
604.01 .....	202
604.02 .....	202
604.03 .....	202

604.04 .....	202
604.05 .....	202
<b>605 - CALCULATION OF SPEED .....</b>	<b>203</b>
605.01 .....	203
605.02 .....	203
605.03 .....	203
605.04 .....	203
<b>606 - MARGIN REQUIRED .....</b>	<b>203</b>
<b>607 - MOTORS .....</b>	<b>203</b>
607.01 .....	203
607.02 .....	203
607.03 .....	203
607.04 .....	204
607.05 .....	204
607.06 .....	204
<b>608 - REQUEST TO ORGANISE .....</b>	<b>204</b>
608.01 .....	204
608.02 .....	204
608.03 .....	204
608.04 .....	204
<b>609 - OFFICIALS .....</b>	<b>204</b>
609.01 .....	204
609.02 .....	205
609.03 .....	205
609.04 .....	205
<b>610 - SPEED RECORDS .....</b>	<b>205</b>
610.01 .....	205
610.02 .....	205
610.03 .....	205
610.04 .....	205
610.05 .....	206
<b>611 - DISTANCE RECORDS .....</b>	<b>206</b>
611.01 .....	206
611.02 .....	206
611.03 .....	206
611.04 .....	206
611.05 .....	206
<b>612 - HOUR RECORDS .....</b>	<b>207</b>
612.01 .....	207
612.02 .....	207
612.03 .....	207
612.04 .....	207
612.05 .....	207
612.06 .....	207
612.07 .....	207
612.08 .....	207
612.09 .....	208



612.10 .....	208
<b>613 - WORLD COMPETITION RECORDS .....</b>	<b>208</b>
613.01 .....	208
<b>614 - PERFORMANCE CERTIFICATES .....</b>	<b>208</b>
614.01 .....	208
614.02 .....	208
614.03 .....	208
614.04 .....	208
614.05 .....	209
614.06 .....	209
<b>615 - HOMOLOGATION OF RECORDS .....</b>	<b>209</b>
615.01 .....	209
615.02 .....	209
615.04 .....	209
615.05 .....	209
615.06 .....	210
615.07 .....	210
615.08 .....	210
<b>700 - ENVIRONMENT .....</b>	<b>211</b>
<b>701 - NOISE LEVEL .....</b>	<b>211</b>
<b>702 - EMISSIONS .....</b>	<b>211</b>
<b>703 - RE-FUELLING .....</b>	<b>211</b>
<b>704 - ENVIRONMENTAL CARE IN RACE AREAS .....</b>	<b>211</b>
704.1 .....	211
704.2 .....	211
<b>800 - CUPS AND TROPHIES .....</b>	<b>212</b>
800.01 - INTERNATIONAL CUPS .....	212
<b>801 - ALFRED BUYSSE TROPHY .....</b>	<b>212</b>
<b>802 - JOHN WARD TROPHY .....</b>	<b>212</b>
<b>803 - BOUCQUEY TROPHY .....</b>	<b>213</b>
<b>804 - DIETER KONIG MEMORIAL .....</b>	<b>213</b>
<b>805 - JOHN HILL MEMORIAL .....</b>	<b>213</b>
<b>900 - UIM RULES FOR RIVER MARATHON RACING .....</b>	<b>214</b>
900.1 - GENERAL .....	214
900.2 - APPLICABLE RULES .....	214
900.3 - RACE OFFICIALS .....	214
900.4 - RACE COURSE .....	215
900.5 - CREW .....	216
900.6 - EQUIPMENT .....	216
900.7 - TECHNICAL SAFETY REGULATIONS .....	217
900.8 - INSPECTION PROCEDURES .....	217
900.9 - GENERAL RACING RULES .....	218
900.10 - FLAG SIGNALS .....	220
900.11 - STARTING .....	220
900.12 - RACE IN PROGRESS RULES .....	222
900.13 - FINISHING RULES .....	222
900.14 - SUPPORT BOATS .....	224
900.15 - INTERNATIONAL RACING CLASSES .....	224
<b>901 - RULES AND CODE OF PRACTISE FOR JETSPRINT RACING .....</b>	<b>230</b>

1. GENERAL RULES.....	230
2. BOAT AND SAFETY EQUIPMENT .....	231
3. ROLL CAGE SPECIFICATIONS .....	234
4. INTERNATIONAL JET SPRINT CLASSES.....	237
5. TESTING PROCEDURES .....	241
6. SPORTSMANSHIP AND COMPETITOR CODE OF CONDUCT .....	242
7. EVENT RULES .....	244
<b>902 - RULES FOR CIRCUIT ENDURANCE CATAMARANS CHAMPIONSHIPS.....</b>	<b>248</b>
1. ORGANISATION .....	248
2. UIM COMMISSIONER.....	248
3. CLASSES .....	248
4. MACHINERY .....	248
5. HULL.....	248
6. BUOYANCY .....	248
7. FUEL.....	249
8. REFUELLING .....	249
9. FUEL DEPOT .....	249
10. NAVIGATION LIGHTS .....	249
11. SLINGS.....	249
12. FIXING EYE.....	250
13. RACE NUMBERS .....	250
14. NATIONAL FLAGS.....	250
15. UIM PENNANTS .....	250
16. SCRUTINEERING .....	250
17. REPAIRS.....	250
18. DURATION.....	250
19. THE CIRCUIT .....	250
20. TURN BUOYS, AND OTHER BUOYS OF THE RACE COURSE.....	251
21. ENTRIES .....	251
22. VALIDITY OF DRIVERS .....	251
23. INSURANCE.....	251
24. TEAMS.....	251
25. TEAM MANAGERS .....	251
26. ADVANCE PROGRAMME.....	252
27. DRIVERS MEETING.....	252
28. PRACTICE .....	252
29. STARTS .....	252
30. FINISHES .....	252
31. POSTING OF POSITIONS .....	252
32. CLASSIFICATION .....	252
33. POINTS.....	252
34. INTERRUPTED RACE .....	253
35. PRIZES .....	253
36. RESULTS.....	253
37. POST INSPECTION .....	253

38.	PENALTIES .....	254
39.	PROTESTS.....	254
40.	YELLOW/RED CARDS .....	254
41.	APPEALS.....	254
42.	BOATS BROKEN DOWN ON COURSE .....	254
43.	PRIORITY OF BOATS .....	255
44.	RESCUE .....	255
45.	PACE BOAT .....	255
46.	CRANES .....	255
47.	FLAGS .....	255
48.	PUBLICITY .....	255
49.	MEDICAL COVER .....	255
50.	DRUG TESTING.....	256
<b>903 - GRAND PRIX HYDROPLANE CLASS.....</b>		<b>257</b>
GENERAL.....		257
903.1 - HULL.....		257
903.2 - ENGINES AND DRIVE SYSTEMS .....		257
903.3 - INSPECTION OF BOATS AND ENGINES .....		258
903.4 - CONDUCT OF RACES (RECOMMENDED FORMAT).....		258
903.5 - DRIVER REQUIREMENTS .....		259
<b>904 - INBOARD RACING DISPLACEMENT CLASS RULES.....</b>		<b>261</b>
<b>905 - RULES FOR CIRCUIT ENDURANCE PNEUMATICS AND V-CLASSES CHAMPIONSHIPS .....</b>		<b>271</b>
1. ORGANISATION .....		271
2. UIM COMMISSIONER.....		271
3. CLASSES .....		271
4. MACHINERY .....		271
5. HULL.....		272
6. BUOYANCY .....		273
7. FUEL.....		273
8. REFUELLING .....		273
9. FUEL DEPOT .....		273
10. NAVIGATION LIGHTS .....		273
11. SLINGS.....		274
12. FIXING EYE.....		274
13. RACE NUMBERS .....		274
14. NATIONAL FLAGS.....		274
15. UIM PENNANTS.....		274
16. SCRUTINEERING .....		274
17. REPAIRS.....		274
18. DURATION.....		274
19. THE CIRCUIT .....		275
20. TURN BUOYS, AND OTHER BUOYS OF THE RACE COURSE.....		275
21. ENTRIES .....		275
22. VALIDITY OF DRIVERS .....		275
23. INSURANCE.....		275
24. TEAMS.....		275

25.	TEAM MANAGERS .....	275
26.	ADVANCE PROGRAMME .....	276
27.	DRIVERS MEETING.....	276
28.	PRACTICE .....	276
29.	STARTS .....	276
30.	FINISHES .....	276
31.	POSTING OF POSITIONS .....	276
32.	CLASSIFICATION .....	276
33.	POINTS.....	276
34.	INTERRUPTED RACE .....	277
35.	PRIZES .....	277
36.	RESULTS.....	277
37.	POST INSPECTION .....	277
38.	PENALTIES .....	278
39.	PROTESTS.....	278
40.	YELLOW/RED CARDS.....	278
41.	APPEALS.....	278
42.	BOATS BROKEN DOWN ON COURSE .....	279
43.	PRIORITY OF BOATS .....	279
44.	RESCUE .....	279
45.	PACE BOAT .....	279
46.	CRANES .....	279
47.	FLAGS .....	279
48.	PUBLICITY .....	279
49.	MEDICAL COVER .....	280
50.	DRUG TESTING .....	280
<b>950 - DRAG RACES RULES .....</b>		<b>280</b>
950.1- DEFINITIONS .....		280
<b>960 - FORMULA FUTURE RULES .....</b>		<b>281</b>
1. DRIVERS, CLASSES AND TEAMS .....		281
2. BOATS, ENGINES AND EQUIPMENT.....		281
3. ORGANIZATION .....		282
4. RACE PROCEDURE.....		284
5. POINT SYSTEM, RESULTS AND PENALTIES .....		286
<b>970 – SOLAR RACING RULES .....</b>		<b>293</b>
1. General .....		293
2. General Rules.....		293
3. Technical condition and safety .....		293
4. Categories .....		293
5. The Boat .....		294
6. Solar panel.....		299
7. Electronics .....		299
8. Appearance of the boats .....		304
9. Inspections.....		305
10. Racing-test.....		305
11. Pilot requirements and communication.....		305

12. The elements of a race .....	306
13. Sprint Competition .....	307
14. Endurance Competition .....	307
15. Time trial .....	308
16. Top Speed Competition .....	308
17. Stage(s) .....	308
18. Slalom Competition .....	308
19. Match Race .....	309
20. Speed Record Competition .....	310
21. Scoring .....	310
<b>971 – SOLAR SPLASH RULES .....</b>	<b>311</b>
<b>FORMULA 1 RULES 2022 .....</b>	<b>329</b>
1. ORGANISATION .....	330
2. RACE FORMAT .....	331
3. START .....	332
4. STOPPED RACE .....	334
5. INTERRUPTED RACE .....	334
6. RACE COURSE .....	335
7. CLASSIFICATION .....	335
8. EQUIPMENT .....	336
9. FUEL .....	341
10. SUPERLICENCES .....	342
11. YELLOW AND RED CARDS .....	343
12. PROCEDURE FOR PROTEST AND APPEAL .....	345
13. SAFETY .....	345
14. GENERAL .....	349
<b>NATIONS CUP RULES 2022 .....</b>	<b>350</b>
1. DEFINITION .....	351
2. RACE FORMAT .....	351
3. START .....	352
4. STOPPED RACE .....	352
5. INTERRUPTED RACE .....	352
6. RACE COURSE .....	352
7. MATCH RACE .....	352
8. CLASSIFICATION .....	353
9. TECHNICAL RULES .....	353
10. FUEL .....	354
11. LICENCE .....	354
12. PENALTIES .....	354
13. PROTEST AND APPEAL .....	354
14. GENERAL .....	354
15. ADVERTISING .....	354

16.	DIGITAL LOGBOOK .....	355
17.	DIGITAL MEASUREMENT CERTIFICATE .....	355
<b>FORMULA 2 RULES 2022 .....</b>		<b>356</b>
1.	ORGANISATION .....	357
2.	RACE FORMAT .....	358
3.	START .....	361
4.	STOPPED RACE .....	362
5.	INTERRUPTED RACE – YELLOW FLAG .....	363
6.	RACE COURSE .....	363
7.	CLASSIFICATION .....	364
8.	EQUIPMENT .....	365
9.	FUEL .....	368
10.	SUPERLICENCES .....	368
11.	YELLOW / RED : BLUE CARDS .....	369
12.	PENALTIES .....	370
13.	PROCEDURE FOR PROTEST AND APPEAL .....	370
14.	SAFETY .....	371
15.	GENERAL .....	371
16.	INSURANCE .....	371
17.	FINANCIAL CONDITIONS .....	372
<b>FORMULA 500 RULES 2022 .....</b>		<b>374</b>
1.	ORGANISATION .....	375
2.	RACE FORMAT .....	375
3.	CLASSIFICATION .....	376
4.	STOPPED RACE .....	377
5.	YELLOW CARDS .....	377
6.	APPEAL PROCEDURE .....	378
7.	SAFETY .....	378
8.	GENERAL FINANCIAL CONDITIONS .....	378
<b>FORMULA 4 RULES 2022 .....</b>		<b>380</b>
1.	ORGANISATION .....	381
2.	RACE FORMAT .....	381
3.	START .....	383
4.	STOPPED RACE .....	384
5.	INTERRUPTED RACE - PACE BOAT RULES .....	384
6.	RACE COURSE .....	385
7.	CLASSIFICATION .....	386
8.	HULL .....	386
9.	ENGINES .....	386
10.	SERIESLICENCE .....	387
11.	PENALTY CARDS .....	388

12. PROCEDURE FOR PROTEST AND APPEAL.....	388
13. SAFETY .....	388
14. GENERAL.....	389
<b>FORMULA 1000 RULES 2022.....</b>	<b>390</b>
1. DENOMINATION.....	391
2. HULL.....	391
3. MOTOR.....	391
4. PROPELLER .....	392
5. FUEL .....	392
6. YELLOW CARDS .....	392
7. COMMITTEE OF APPEAL .....	393
8. SAFETY.....	393
9. GENERAL.....	393
<b>CODE OF PRACTICE FOR MEDICAL &amp; SAFETY F1 &amp; F2 RACES .....</b>	<b>394</b>
1) RESCUE BOATS.....	395
2) CREW MEMBERS.....	395
3) MEDICAL ASSISTANCE .....	395
4) GROUND ORGANISATION .....	395
109.09 - MEDICAL EVALUATION SHEET .....	396
109.10 - GENERAL OBJECTIVE EXAMINATION.....	397
109.11 - ADDITIONAL ITEMS FOR SUPER-LICENCE .....	398
<b>CODE OF ETHICS 2022 .....</b>	<b>399</b>
<b>ANTI-DOPING RULES 2022.....</b>	<b>406</b>
<b>ENVIRONMENTAL CODE 2022 .....</b>	<b>466</b>

## **101 - UIM EVENT SANCTIONS AND THE SPORTS CALENDAR**

### **101.01 - EVENT SANCTION REQUIREMENTS AND FEES**

All international powerboating events must be sanctioned by the UIM and by the National Authority. An International Sanction is a written authorization which permits an organizing body to conduct an international event under the rules of the UIM. These events may include national racing classes open to international drivers, when so stated in the advance program. In these cases, UIM rules apply to the event but not to the technical rules of the national classes.

Written approval by the UIM of the registration of an international event on the UIM annual calendar, subject to payment of a fee determined Bi-annually by the General Assembly, constitutes the granting of an International UIM Sanction for that event.

Permission to organise these meetings is only delivered by the UIM upon payment of these fees. No permission is to be granted to National Authorities in arrears of payment.

All requests to organise an International championship must be sent to the UIM Secretariat before the time set by the deadline in the rules.

The organisation of an event cannot be granted if the title, the classes to race, the registered race course (for Circuit) and the date of the event are not given.

The titled meetings have priority over all other meetings before the closing of the registrations for the sports calendar. However, when the sports calendar is finalised, all the motorboating meetings are on an equal footing.

In order to promote new series and classes, new hulls, motors or engines, new ideas regarding propulsion and new concepts of racing, the Council may, provided the request to organise be accompanied by an amount equal to double the fee of an ordinary meeting, approve the organisation of international contests for such boats, motors or engines, type of propulsion and races of a kind not yet known to the UIM provided such events do not clash with other UIM titled meetings at the sole discretion of UIM.

The National Authority where an event starts shall be the main sanctioning body and responsible to the UIM. All National Authorities through whose waters the event passes must also approve the event.

When compiling the Sport Calendar due attention is to be paid to the confidential reports of the UIM Commissioners before granting the authorisation to organise titled meetings.

The organisers must name the series and classes which may participate and also give the name and address of the organisers and/or the responsible person (s) who are in a position to supply information about the event. They must also name the type of races: titled, championship, etc., the locality, as well as the date of the inscriptions.

Such information must be provided as soon as possible.

Fees for multi-class events:

Two Circuit titles at one event	Second calendar fee invoiced @ 50%
Three Circuit titles at one event	Second calendar fee invoiced @ 50% Third calendar fee invoiced @ 25%
One class or sub-class at one event	One fee
Offshore 3J, 3A and 3B at one event	One fee
Offshore 3A, 3B, 3X and 3C at one event	One fee
Two or more Offshore classes (except above mentioned) at one event	Two fees
Promoting of new (not yet known to UIM) series, classes, hulls etc	Double fee

Payment of these fees must be made within three months after the fixing of the International calendar. It is compulsory even if the meeting does not take place.

Except Hydro GP events which are due: 50 %, two months after allocation and next 50 %, twelve months before event.



## 101.02 - OTHER MEETINGS

The UIM Sport Calendar also lists the registered international ordinary meetings.

No UIM national authority in the same continent shall have an international race on its calendar of the same class, as a UIM World or Continental Championship on the same date, based upon dates sanctioned at the UIM General Assembly. To protect titled meetings, the UIM Council may refuse to sanction these meetings. Such refusal is only notified at the specific request of the National Authority lodging a protest.

No national championship race may be run at the same week-end as a UIM World, Continental, or Regional Championship race, in the same continent, for the class concerned.

The calendar of national or local events is not to be submitted to the UIM. The interested National Authorities take responsibility for their own calendar.

The UIM does its utmost to avoid clashes between ordinary meetings. However, whether the interested parties agree or disagree, the UIM lists all requests for dates, leaving the organisers to sort out their responsibilities.

A titled meeting which has been cancelled does not count any longer for the title. If the organisers decide to run the race in spite of the cancellation, the race must be considered as an international ordinary race.

For a World or Continental Championship, no national championship race, for the same class(es), may be run on the weekend before the World Championship, run in the same continent. This is providing the championship race has been announced in accordance to UIM dates.

## 101.03 - DEADLINE DATES

A National Authority may apply for UIM titled races for the next season by sending applications to the UIM office.

In case of International Hydro GP events, all following dates refer to the year preceding the proposed event

- 1 January:** Applications from NA for Circuit Hydro GP events with dates/venues
- 31 January:** Allocation of Circuit Hydro GP events by Cominsport
- 1 February:** Send list to NA's of all titled events available not run in Circuit Hydro GP events.
- 1 March:** Forwarding of requests by National Authorities for international titled events with venues
- 1 April:** Allotting of titled events to NA for the following year by relevant commission
- 15 April:** Publishing of all UIM title allocation for the following year
- 10 September:** Forwarding of dates and venues of titled events by the NAs.  
Forwarding of request for ordinary international events, complete with dates and venues.

**General Assembly calendar Meeting:** Drawing-up of the international calendar.

**15 December:** Publishing of the international calendar.

A National Authority may apply for a titled race two years ahead and relevant Commission allocates these events at the UIM General Assembly year earlier. Council may allocate an international Circuit titled event for unique occasions to an NA at the General Assembly more than one year ahead. This is necessary when organizers need more time to prepare financial and organizational matters for a UIM titled event.

Application in these two cases from the NA must be sent to the UIM no later than 1. September of the year that Council, in agreement with relevant Commission and the involved Committee, will process the application during the General Assembly. Additionally, the NA must pay the current race inscription fee upon UIM's acceptance of the proposal, which will not be refunded unless the organizer gives back or cancels the event before 15. August of the year preceding the race.

## 101.04 - LATE REQUEST, CHANGE OF DATE AND CANCELLATION

### Titled events

Late request: a late request will be considered only if the title is still vacant or if the title or the event has been cancelled by the NA to whom it was granted or by the UIM if the title is granted, the organiser will pay the normal inscription fee.

Late forwarding of date or venue: the inscription fee will be raised by 50%

Change of date: the inscription fee will be raised by 25 %. The UIM gives its assent to the new date. The request for a change of date must be received by the UIM secretariat not less than 90 days before the calendar date. The new date will be approved and announced not less than 30 days after the date on which the request was received.

At less than 90 days before the calendar date, the date cannot be changed. The event will be cancelled or run as an ordinary event, but no part of the calendar fee will be refunded.

Cancellation: if the title or the event is cancelled 90 days or more before the calendar date, 50 % of the inscription fee will be refunded. In a later cancellation there will be no refunding. A cancelled title will be treated like a title not yet requested.

If the titled event is cancelled less than 30 days before the calendar date, the National Authority may not be allowed to organise a titled event the following year.

For «Hydro GP events» the following will apply:

- no late requests
- no change of date or venue unless agreed by Cominsport at least 120 days before the old date and 120 days before the new date
- no refund of inscription for cancellation
- no round of the series can be re-allocated except if a complete Hydro GP event is cancelled before fixing the UIM Calendar at the GA or failure of payment of the relevant fees by the set deadlines. (i.e 12 months before event Rule 101.01). Allocation of cancelled Hydro GP Classes can be re-allocated by Cominsport to any requests from N.A's. Normal Rates to apply (Rule 108.03).

#### **International Ordinary events**

Late request: the inscription fee will be raised by 25%.

Change of date: the inscription fee will be raised by 25%.

Cancellation: If the event is cancelled 30 days or more before the calendar date, 50% of the inscription fee will be refunded. In later cancellations there will be no refunding.

### **103 - RACES RECOGNISED BY THE UIM**

The UIM recognises the following events/races organized under UIM rules:

- Titled International events
- Ordinary International Events / International Ordinary races
- International cruises

The U.I.M. recognises the following events/races organized under UIM rules or national rules:

- National and local events
- Private meetings or club events

### **104 - NON APPROVED RACES**

All races not organised according to UIM rules are not to be recognized.

The same applies to motorboating events not approved by National Authorities.

A national race, or a race by "invitation" in which a foreign licensed driver is invited to take part must be entered on the UIM Calendar otherwise it becomes an unauthorised event, unless no more than 3 foreign drivers take part for the reason of training and without inclusion of their results/times in the results sheets. Remember that drivers having international licences, are only allowed to enter a meeting outside the country of their license, provided that their National Authority gives them written permission to do so.

### **104.01 - SPECIAL LICENCES**

Without prejudice of the foregoing the Council may, on a yearly basis, issue a certain number of Special Licences for riders and teams, allowing them to compete in races organized by non-UIM entities or under the aegis of entities other than the UIM and its National Authorities.

Such Special Licences shall be granted to National Authorities, which shall issue them to the riders or teams applying accordingly.

Special Licences can only be granted to the holders of UIM international licenses. Special Licences shall be effective upon payment of the relevant fee, to be established by the UIM Council every year, and shall be valid for a maximum of three races in the year they have been issued.

Holders of the Special Licences shall execute a discharge of liabilities vis-à-vis the UIM and the relevant National Authority. Such discharge of liabilities is condition precedent for the effectiveness of the Special License.

### **105 - TITLED INTERNATIONAL EVENTS**

There are six categories of titled event:

- World Championship events,
- World Cup events,
- Continental Championship events,
- Continental Cup events,
- Grand Prix events,
- International Hydro GP events.

There can be one World Cup and Continental Cup event per class and per year, provided that a World or Continental Championship is not organised for the class in question.

There can be only one Grand Prix event per country and per year, except when a World Championship series race takes place in that country.

No meeting is allowed a title unless authorised to do so by the UIM who draw up the annual list in the official calendar.

Except for Formula Future and American Power Boat Association classes, and championships for Jet Sprinting, River Marathon, the RD classes, and GP Hydro, if a scheduled UIM "Championship" titled event for a specific class takes place with fewer than 10 participating drivers from fewer than 3 National Authorities over two consecutive years, future titles awarded for this class may be "Cup" unless and until COMINSPORT determines otherwise. In the case of titles awarded as a result of a series of (more than one) races, the participant drivers in any one event may be counted to comply with the minimum participation numbers. For class Formula R1000 only, if a scheduled UIM "Championship" titled event takes place with no fewer than 4 participating drivers from no fewer than 2 National Authorities, before January 1, 2022, the titles may be awarded provided the boats comply with all the rules specified under rule 516 – CLASSES regarding cockpits. After January 1, 2022 the minimum requirement for class Formula R1000 returns to at least 10 participating drivers from no fewer than 3 National Authorities.

During prize presentations and ceremonies at UIM titled events, any UIM medals shall be presented by the highest ranking UIM representative(s) in attendance at the event.

## **106 - INTERNATIONAL CHAMPIONSHIPS, WORLD AND CONTINENTAL CUPS**

### **106.01- GENERAL RULES**

World Championships are open to all specified U.I.M. classes and A.P.B.A. classes. There can be only one World Championship per class (UIM or A.P.B.A.), per year. The requests to organise these championship must be sent in due time. Only the Sports Commission (Cominsport) will allocate the Championships.

No exception is to be allowed to the preceding rule.

UIM has created Formula World Championships for the following UIM Classes:

F1, F2, F4, F500, F250, F125.

And Formula European Championships for the following UIM Classes:

F1000, FR1000, F350.

All to be run as a Series, although a Winner can be declared if only one event is held.

UIM Titled International events will only be granted permission by Cominsport on a venue within the UIM listings agreed and approved by Cominsport

MINIMUM criteria for UIM race Course/Venues:

- 1) Minimum number of boats registered to be raced at one time: 12 in 2021 and 16 as from 2022,
- 2) No clock start,
- 3) Correct length and width of jetty. Must be very stable to take relevant boats for safe launching,
- 4) Organisation to guarantee:
  - a) Full medical rescue as UIM rules,
  - b) Full experienced organisation to UIM rules,
  - c) Computerised timing equipment and experienced staff,
  - d) Adequately controlled pit area on hard surface,
  - e) Free electricity in the pit area,
  - f) Adequate toilets and showers (hot),.
  - g) Podium for prize giving ceremony with stand for first three places and with a full background of the podium.

No hidden charges for competitors like garbage bag deposit, other event tickets etc.

Other points to be added on experience.

The UIM delivers following requests made by the champions to their National Authorities and transmitted by that National Authority to the UIM Secretariat a "champion's certificate".

The cost of such certificate is fixed annually by the General Assembly and is to be paid by the National Authority to the UIM when the request is made.

A list of champions is issued annually.

The U.I.M. rules and those of the National Authority are applicable for any point not foreseen by these rules.

A non European may be proclaimed European Champion provided he holds a current valid International Licence. The same applies for other continents.

### **106.02 - WATER REGISTRATION**

Permission for any UIM sanctioned race meeting is granted ONLY if the race course is approved by UIM Cominsport before the National Authority applies for the international event. A UIM sanctioned race without an approved Water Registration for the registered categories is not permitted. Reallocation of the race is permitted only to a race course with a valid Water Registration. A Water Registration for a specific course is valid for four years. A Water Registration validity may be extended three years by sending a new application to the UIM.

If the course and UIM rules for the courses are not changed, new application documentation is not required. Water Registration is subject to payment of the fee determined annually by the UIM General Assembly.

Handling time for the Water Registration application is three calendar months from the date of application. Both the UIM and the organizer are responsible for a timely completion.

All National Authorities MUST approve such courses and send the Water Registration documentation to the UIM in English, including:

1. Minimum depth of the race course for all circuit classes up to 1000cc is 2 meter
2. Minimum depth of the race course for cockpit classes up to 1000cc is 3 meter
3. Minimum depth of the race course for all other classes is 4 meter. For Formula 1, if the rescue boats are equipped with front crane device the minimum can be reduce to 2,50 meters.
4. A PLAN to scale (1:500 ... 1:2 000) with graphic scale representation and geographical north - A3 color copy
5. Coloured photographs of the surrounding area (banks, sea walls and others)
6. Fully filled UIM official Questionnaire for Water Registration
7. Environmental plan of the race event

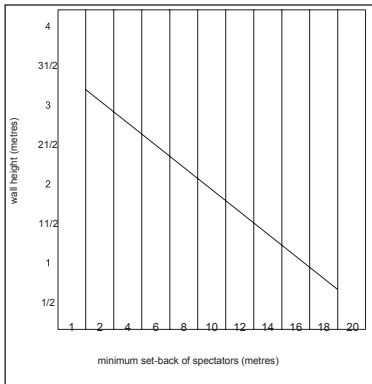
The PLAN must include accurate information about the circuit (refer also rules on the blue pages section of the "UIM Circuit Rules" book when applicable):

1. Position of ALL race buoys (must be measured with GNSS (GPS) in coordinate system WGS84).
2. Position of finish line (must be measured with GNSS (GPS) in coordinate system WGS84).
3. Position of jetty/beach (if applicable) or start line
4. Jetty position for pole position boat
5. Start lights or clock position
6. In case of using alternative start procedure (307.02) position of alignment buoy and distances to that from start jetty
7. Distance from start jetty to the first actual turn buoy
8. Lengths of all straights (302.01)
9. Minimum width of race course
10. Direction of the race course
11. Other obstructions duly marked, including marking by buoys the extreme outside of the race course on critical places where boats are exiting fast corners
12. Exit and entrance lines and buoys used for that
13. Any other buoys not applicable to the race
14. Position of control
15. Entry to water... crane/slipway
16. Area for pits
17. Spectator barriers etc. (see drawing). The spectator areas must be shown and minimum distances between spectator areas and the course marked on the plan. Natural or man-made spectator protection such as fences, docks, etc. shall be noted. The circuit plan and spectator areas shall be positioned to provide for spectators and drivers safety. Spectators and crews shall not be in the water during the running of a race
18. Position of ambulance and CLEAR access.
19. Free way out for the ambulance
20. Position of mandatory land based First Aid accommodation
21. An ALTERNATIVE race course (if possible) only for use under "Force Majeure" conditions
22. Position of sound level meter.

## 23. Position of Parc Fermé

Minimum requirements and information of circuit:

1. Correct lengths of the laps for classes to be raced (302.01)
2. Correct lengths of straights (302.01)
3. Correct length of start straight (307.02, 302.01)
4. Correct length and width of start jetty (307.01)
5. The minimum depth of the race course for registered categories.
6. The minimum depth of the water at jetty
7. The minimum width of the race course is 75m between buoy and shore. If less, number of maximum number of boats has to be defined to guarantee safe racing.
8. Altitude of venues
9. Tides chart of the relevant race days
10. List of all possible classes/categories allowed to race
11. Maximum number of boats allowed to race in each class (106.01)
12. For circuit races, bridges in the circuit should be avoided. If unavoidable, minimum opening clearances must be 50 m width for hydros, 80 m width for other classes and 15 m vertical clearance, except for endurance races.



## Questionnaire for Water Registration

Current official questionnaire for water registration is available from UIM office. Questionnaire includes following minimum information:

COUNTRY:

PLACE:

NATURE OF WATER:

NUMBER OF BUOYS:

DESCRIPTION OF TURNING BUOYS:

MINIMUM DEPTH OF CIRCUIT (Jetty and Race course):

MINIMUM WIDTH OF RACE COURSE:

START METHOD:

LENGTH OF START JETTY:

HEIGHT OF THE BANKS:

ENTRY TO WATER:

PLACE AVAILABLE FOR PUBLIC:

PROTECTION OF PUBLIC:

ALTITUDE OF VENUE:

CATEGORIES TO RACE (for each category):

LENGTH OF LAP (CIRCUIT):

MAXIMUM STRAIGHT:

MAX NUMBER OF BOATS TO RACE:

N.A. STAMP Registered on: UIM STAMP

Registration n°:

Registration valid till:

Environmental plan

1. Garbage Boxes
2. Wasted oil boxes
3. Adequate number of toilets
4. Shower rooms
5. Fire-extinguishers

Every new registration is given under the condition that the UIM commissioner at the first event must approve that this site conforms to the registration file.

## **107 - WORLD CHAMPIONSHIP**

World Championships, allocated by the UIM Sports Commission are raced under the same rules as the Continental Championships.

To avoid any confusion about the value of the title, there will be no class World Championship when such Championship is organised under the Formula system.

## **108 - CONTINENTAL AND WORLD CHAMPIONSHIPS**

### **108.01 - NUMBER OF CHAMPIONSHIPS**

There can be one championship per year, per class, per continent (except where there is a series) but only in classes approved by the Cominsport at least 13 months before the applicable year. To apply for Continental or World Championship races or series rounds, National Authority application has to include the following information:

- Classes and titles raced at the event
- Dates of the event
- Race venue. Race venue has to have a valid UIM Water Registration (see rule 106.02) at the date of the application. In case it does not exist at the moment of application, the Water Registration has to be made in the next three months from the date of application; if not, the titled race will be given to the next organizer in the application list, which fulfills all the requirements.

- Information about experience of the organizer. All minimum criteria for UIM race have to be fulfilled (see rule 106.01).

The right to organise Continental and World Championships is annually rotated in alphabetical order of the Initials of the English names of the affiliated countries applying. However, when National Authorities apply for a Hydro GP event, no rotation will be used.

In the case of an application for a multi-class event (except Hydro GP), where rotation of the NAs' organization right is not violated, the decision will be made by a vote of UIM Cominsport.

In the case of a series (F4, etc.) proposal concerning race organizers, decisions are made by the applicable UIM Cominsport working group and finally approved by UIM Cominsport vote. Each application will be judged on its own merit by Cominsport before allocation.

If a nation declines to organise a championship the next in rotation is taken into consideration.

If a country is allocated a UIM title for a certain year but fails to organise it, this country is considered as having held the championship as far as rotation is concerned.

## 108.02 - EUROPEAN CHAMPIONSHIP SERIES

All UIM European Championships are conducted as follows:  
All classes will be a single event except the following classes.

Series:

Formula 350	All races = 3 heats.	All points count.	Up to 3 race series
Formula R1000	All races = 4 heats.	3 best heats to count.	Up to 4 race Series

Every race for the Championships must be run in accordance with UIM Rule 108

Points scoring: See Rule 317 (Series)

UIM will supply Medals for 1-2-3 places at the final race of the series.

Title is awarded even if only a single event is run.

Travel/start money.

Foreign drivers (those drivers with their Nationality as shown on their International licence and the National Flag attached to their boat. If different then the Flag on the boat determines payment. Who successfully start either official practice/time trials/qualifying or race will receive the following:

Formula 350	Euros 200
Formula R1000	Euros 100

## 108.03 - WORLD CHAMPIONSHIP WITH HYDRO GP

HydroGP:

World Championships are a series for UIM classes Formula125, Formula 250 and Formula 500 (see Formula 500 World Championship in "blue" pages)

All HydroGP's must include all the three UIM classes set out below.

From 1.1.2023

Formula 125	All races = 3 heats	All points to count	Series maximum number = 5
Formula 250	All races = 3 heats	All points to count	Series maximum number = 5
Formula 500	All races = 3 heats	All points to count	Series maximum number = 7 but only 5 races within HydroGP Series. (See Formula 500 rules, Blue pages)



Travel/start money. Euros 3 000 per class

Foreign drivers (those drivers with their Nationality as shown on their International licence and the National Flag attached to their boat. If different then the flag on the boat determines payment. Who successfully start either official practice/time trials/qualifying, or race will receive up to a maximum:

Formula 125	Euros 250
Formula 250	Euros 250
Formula 500	(See Formula 500 rules, Blue pages)

Exception to the above: If any driver is a resident in the host country but has an International licence issued by another, they will not be due for any payment under this rule.

Classification: Points scoring see Rule 317 (Series.)

UIM will supply Medals for 1-2-3 places at the final race of the series.

Titled is awarded even if only a single event is run.

National Authorities application to organize HydroGP has absolute priority over any other application within these classes.

If the full application of HydroGPs is not allocated, then the remaining rounds of the three classes may be allocated by the UIM, as separate events, to N.A's applying when requested by Cominsport, Travel/start money included. Any HydroGP or separate event including one of these classes must be scheduled over maximum two days.

Any practicing/training outside these two defined days are totally unofficial and never used in any official way. Only one other UIM Titled class may be allocated to be included in a full HydroGP programme.

## 108.04 - ENTRIES

Each National Authority may designate drivers according to its own rules.

Entries are to be sent through their National Authority to the organiser, no later than 28 days, before the start of the meeting. Failure to meet this deadline may result in the driver losing any scheduled travel money.

When entering a UIM Titled event, each driver must indicate the names of his/her mechanics/associates authorized to enter the pits. These names must be confirmed/verified at signing on schedule.

Drivers in the classes, where UIM Digital Logbook or UIM Digital Measurements Certificate is in use, must add Hull Identification Number (HIN) to the Entry Form.

## 108.05 - HEATS AND LENGTH

A UIM championship can only be held during an International sanctioned meeting. The race must include four heats unless otherwise provided for in the UIM rules. Electrical classes ET-15 and EH-15 race include three heats, all points count. Every heat must have a length of:

6 to 8 km	for the class OSY 400, JT 250, T250, GT15, ET-15, EH-15
8 to 12 km	for racing outboards 125cc and 175cc,
12 to 17 km	for racing outboards 250 cc - 700 cc, F4 and GT30 for inboards up to 1000 cc for all classes in S.P.T. up to 550 cc
20 to 30 km	for racing outboards 850 cc to ∞,
20 to 25 km	for all other classes.

With interval of at least one hour between the finish of one race/heat/qualifying and the next race/heat/qualifying that involves any same driver in the same class.

## 108.06 - RESULTS

A driver's three best heats of the four are to be considered for the results, except in Hydro GP and other classes as listed elsewhere where all heats raced will be considered for the results.

When through force majeure (bad weather etc.) the heats are reduced in number or length the final positions are a valid race result.

All classes must race separately even if they belong to the same series.

The races for the Championships are not to be combined with races for other cups or trophies bearing another name.

The organising club will present a gold - silver - bronze medal to the top three drivers, unless UIM distributes the medals (to World Championships and to Formula European Championships).

Other prizes may be awarded.

A driver who has entered for a Continental Championship cannot be compelled to enter other races programmed during the meeting.

As soon as the results have been verified, the National Authority and the UIM Commissioner forwards these results to the UIM Secretariat. ***In case of classes, where UIM Digital Logbook or UIM Digital Measurements Certificate is in use a list of drivers with the Hull Identification Numbers (HIN) of the boat used, needs to be forwarded to UIM Secretariat.*** Up to ten photos of the race may be included.

## 109 - RACING LICENCES

### 109.01 - COMPULSORY LICENCE

No one can take part in a race, establish or improve on a record, or test drive at any titled event as a driver or crew in International class boats, without being in possession of a licence from his National Authority.

Anyone responsible for controlling a boat in any competition and holding the necessary driver's licence issued by the National Authority is considered to be the driver.

An international racing licence may be granted by a National Authority to a driver whom, in their professional judgement, has the capability to participate in a UIM international event.

Any driver or crew member that rides in a boat fitted with restraints must partake in a suitable Driver immersion training annually prior to being issued with his current licence. Such licensed persons shall have their licences endorsed as "Driver immersion training : expiry date ....!.../.... (day/month/year)".

#### 109.01.01

In order to obtain an International licence, Super Licence or Series Licence, following disclaimer must be signed by the licence holder:

"The undersigned ... licensed driver (licence n° ...), participating to UIM sanctioned events, yields the media rights of any coverage by the promoter taken during the event, to the UIM for further use press, radio or television. The right however remain the property of the undersigned.

In addition I herewith agree and acknowledge the following:

UIM is the governing rule making body of UIM racing events which are responsibly organized by clubs, national authorities of UIM, contracted promoters or other organizers. These organizers do not act on behalf of the UIM and UIM is not responsible for any act or omission of such organizer and shall not be liable to the participant accordingly.

The UIM sport and technical rules are intended to minimize risks but they cannot provide the highest possible safety standards at all times. Residual risks might remain.

Enforcement of the rules by UIM or other race officials and in particular but not limited to the technical scrutineering does not guarantee the safety of racing or the safety of the scrutineered boat. Scrutineering is not intended as a construction/ condition survey. The racing license issued by the National Authority or a super license issued by the UIM does not guarantee that a driver is physically able to race safely nor that he has sufficient experience or education.

Teams and drivers are solely responsible for their own safety including but not limited to their physical and educational ability to race in the relevant class, the safety of their boats and other gear and the safety of their racing activity. This responsibility includes racing with prudence and taking technical measures which are not mandatory in the rules but deemed necessary.

UIM shall not be liable for any damage, injury or death due to inadequate rules, breach of existing rules by participants or failure to enforce rules by the race officials."

The signed disclaimer can be requested by the UIM commissioner at any UIM sanctioned event.

## **109.02 – REGISTRATION**

The National Authority establishes each year a list of people to whom international licences have been delivered and this must be sent to the UIM Secretariat.

The list must include: the name and surname, the address, the class(es) for International Licences only and the Appendix 3 Anti-doping consent form of UIM Anti Doping Rules duly signed per acceptance.

These lists may be sent to others National Authorities upon request.

Licence numbers are given annually by the National Authority to the owners and drivers entered on the list. Any person wishing to obtain a licence must apply to the National Authority through his club.

The licence is granted by the National Authority and is marked "International" as decided by the National Authority.

The digital version of the currently valid UIM rulebook (if applicable) must be made available by the National Authority to the licences together with the international licence.

Any National Authority has the right to deliver licences to:

- its nationals;
- nationals of another country affiliated to the UIM but with the agreement of the National Authority of that nation.

With the approval of the UIM a National Authority may also deliver licences to persons belonging to a country which is not yet affiliated to the Union.

Nobody is allowed more than one driver's licence.

A National Authority may refuse to give a licence without having to state the reason. Notification of this is sent to all affiliated clubs and to UIM.

## **109.03 - VALIDITY OF LICENCES**

Licences are valid from the 1<sup>st</sup> January until the 31<sup>st</sup> December each year, unless local circumstances require other dates, but validity should always be shown on the licence itself.

An International licence is valid in any country affiliated to the Union and entitles the holder to enter or drive his boat in all competitions organised in any affiliated country, provided he complies with what is stated in the UIM general racing rules.

However, for any event held under special rules, the licence holder must abide by the rules in question.

#### 109.04 - COST OF LICENCE

The cost of the yearly licence is to be fixed by the National Authority.

#### 109.05 - EXAMINATION OF LICENCES

At any meeting, the holder must produce his licence at the request of any official of the meeting.

#### 109.06 - CANCELLATION OF LICENCE

Intentionally left blank

#### 109.07 – PSEUDONYM

The use of a pseudonym must be requested from the National Authority and the National Authority marks the pseudonym on the licence.

A licence holder, so long as he is listed under a pseudonym, may not take part in any sports event under any other name.

Changing a pseudonym is subject to the same formalities as the adoption of it. Anyone who has chosen a pseudonym may not return to his actual name until the National Authority has agreed and has delivered a new licence.

#### 109.08 - SUPER-LICENCE ENDORSEMENT FOR WORLD FORMULA SERIES RACING

**109.08.01** Before being granted a super-licence for the first time, drivers must have fulfilled the Super-licence requirements of the relevant class. See rules from blue pages.

**109.08.02** In the World Series F500, F250, F125 there is no super-licence but National Authorities will have to send to UIM before the end of February the list of drivers racing in these categories and formulas, with their addresses. An F4 Series-licence is required for the F4 World & Continental Championships.

**109.08.03** The Secretariat of UIM will hold all the information referred to in 109.08.02 as soon as it is received.

#### 109.09 - MEDICAL EVALUATION SHEET

Location of test \_\_\_\_\_ Date \_\_\_\_\_

Name \_\_\_\_\_ Surname \_\_\_\_\_

Born in \_\_\_\_\_ Date \_\_\_\_\_

Address \_\_\_\_\_

Status \_\_\_\_\_ Profession \_\_\_\_\_

Date of first involvement in the sport \_\_\_\_\_

Other sports practised \_\_\_\_\_

##### PRESENT STATE OF HEALTH AND FORMER DISEASES

Disease (former or current) \_\_\_\_\_

With special mention of \_\_\_\_\_

Cardiopathy     Coronary     Diabetes Type 1 / 2 (circle the type)

Epilepsy     High blood pressure

Operations undergone previously \_\_\_\_\_

Dates of these operations \_\_\_\_\_

Accidents (when, where, under which circumstances) \_\_\_\_\_  
 \_\_\_\_\_

Alcohol g/day \_\_\_\_\_ Tobacco pack/year \_\_\_\_\_

Allergies \_\_\_\_\_

Medicines usually/frequently taken \_\_\_\_\_

Please keep in mind the Anti Doping rules and the WADA – UIM list of banned substances and Therapeutic Use Exemption rules.

### 109.10 - GENERAL OBJECTIVE EXAMINATION

Height m \_\_\_\_\_ Weight kg \_\_\_\_\_

(Exemption of BMI rule over 30 kg/m<sup>2</sup> : Please refer to the superlicence procedure posted on the UIM website)

Age \_\_\_\_\_ Sex \_\_\_\_\_

Congenital or acquired deformities \_\_\_\_\_

Respiratory system \_\_\_\_\_

Spirometry (mandatory) Please attach printed results and graphs \_\_\_\_\_

FVC (measured/predicted) \_\_\_\_\_

FEV<sub>1</sub> (measured/predicted) \_\_\_\_\_

Cardiovascular system : is there any evidence of abnormality of the heart or cardiovascular system ? o Yes o No  
 If "Yes", give details below.

Blood pressure at rest \_\_\_\_\_

Heart frequency at rest \_\_\_\_\_

Electrocardiogram at rest \_\_\_\_\_

Please attach printed results and graphs and final report in English language

Ophthalmologic check-up (mandatory every other year)

Have you undergone this ophthalmologic check-up last year ?

**If yes**, please specify when : .. / .. / ....

**If not**, ask your ophthalmologist to fill the hereafter items

Faculty of vision (uncorrected) R \_\_\_\_\_ L \_\_\_\_\_

(with correction) R \_\_\_\_\_ L \_\_\_\_\_

Vision with both eyes open (wearing corrective lenses if necessary)

Field of vision \_\_\_\_\_

Vision of colours: is the applicant's colour vision normal?

o Yes o No

If "No", give details below.

Signature and practice stamp of the ophthalmologist

Hearing testing \_\_\_\_\_

Urine: Albumine \_\_\_\_\_ Sugar \_\_\_\_\_

Is the Urine analysis normal? o Yes o No

If "No", give details below.

Nervous system \_\_\_\_\_

Others \_\_\_\_\_

Does the applicant have any physical abnormality or restriction of movements in the arms or legs? o Yes o No  
If "Yes", give details below.

Is there any evidence of a physical or mental condition (past or present) which could, in your opinion, prevent the applicant from holding a competition licence for motorsport ?

o Yes o No

If "Yes", give details below.

To the Doctor and the Driver :

Are you the applicant's usual doctor? o Yes o No

Your practice stamp (together with your name and qualifications):

Name in capital letters \_\_\_\_\_

Degree \_\_\_\_\_

Address \_\_\_\_\_

Tel \_\_\_\_\_

Fax \_\_\_\_\_

Aptitude assessment \_\_\_\_\_

Date \_\_\_\_\_

This is to certify that I have examined the applicant in line with this form.

Signature of the Doctor \_\_\_\_\_

Signature of the Driver \_\_\_\_\_

### 109.11 - ADDITIONAL ITEMS FOR SUPER-LICENCE

Maximal stress ECG and blood pressure profile: electrocardiogram have to be performed:

\* on a cycloergometer starting at 60 or 70 watts and increasing by 30 or 35 watts every two minutes.

The driver must be capable of reaching a minimum power level of 2.5 watts (males) – 2.2 watts (females) per kilogram of body weight.

\* or on a treadmill, using a Bruce protocol (preliminary warm-up recommended)

The driver must be capable to complete at least the entire stage 3 (i.e. 3 minutes at 5.5 km/h (3.4 mph) and 14% gradient).

### 109.12 - ELECTION OF DRIVERS REPRESENTATIVE

There may be a Driver's Representative from each International racing class.

The election of each representative must be held in the presence of an UIM Official. Candidates must be real drivers.

To be eligible, they must have obtained the following minimum experience :

Have competed in International races and be regularly racing. Candidates must be nominated by their National Authority, prior to the mid term meeting and selected by relevant commission.

Driver's Representatives are elected for a 2 years term, beginning January and ending the next calendar year December. They should be available to attend relevant commission/Working Group meetings at least annually to

report and advise on the consensus recommendations and requests from the drivers. Otherwise a full written report must be forwarded to the relevant UIM commission minimum of 30 days prior to the General Assembly.

### 109.13 – MODEL APPLICATION FORM FOR A LICENCE

The undersigned \_\_\_\_\_

Date of Birth : .... / .... / ....

begs to apply for National Driver's

a licence International Owner's

I have read the UIM licence rules and will abide by same.

The pseudonym chosen is \_\_\_\_\_

Enclosed please find the licence fee \_\_\_\_\_

\_\_\_\_\_ the \_\_\_\_\_

signature \_\_\_\_\_

address \_\_\_\_\_

Member of \_\_\_\_\_

To be sent to the Secretary of the National Authority through the Club.

### 109.14 - MODEL OF LICENCE

20 \_\_\_\_\_

The National Authority's Licence Book)

N° \_\_\_\_\_

	LICENCE	
NATIONAL OR		OWNER'S
INTERNATIONAL		DRIVER'S

Delivered to M \_\_\_\_\_

Member of \_\_\_\_\_

Valid until \_\_\_\_\_

Pseudonym \_\_\_\_\_

"Driver immersion training : (expiry date .... / .... / ....)"

(Here name of National Authority)

Secretary,

President

Signature of Licence Holder

### 110 – UIM COMMISSIONER

The presence of both a Sports Commissioner and a Technical Commissioner of the UIM is required at any International titled meeting. In circuit racing the Technical Commissioner is only required for classes using Low Emission engines (example: GT15/GT30/F4/F2), excluding FF for World and Continental Championships to oversee and assist the technical inspections. The UIM Technical Commissioner is assigned by UIM from the Technical Commissioner's List (nominated annually by National Authorities).

His/her role is to ensure a fair and safe race competition according to the UIM regulations and rules. He/she ensures that UIM rules and regulations are adhered to.

As soon as UIM gets the Commissioner's agreement, the Secretary General of the UIM will send a letter to the National Authority informing them that the Commissioner has been designated for the events referred in the letter.

Special consideration can be given to a National Authority that is distant from any other UIM National Authority and therefore substantial travel costs may be involved to obtain a suitable Commissioner.

If a local qualified, impartial UIM International Officer that is known by Cominoff, Cominsport or Comintech and generally works within a different code of the sport to that being adjudicated, such person may be appointed UIM Sport or Technical Commissioner to an event within their country.

The UIM Sport and Technical Commissioners sent to the competitions should come from a Nation near to the organising one and not from different continents.

### 1. Tasks and function of the UIM Sports Commissioner

The UIM Sports Commissioner is the representative from the UIM and his/her duties are very diverse:

1. He/she assists the local organizer and more particularly the Officer of the Day (O.O.D.), and Assistant O.O.D./Safety Officer.
2. On the day prior to the first race/practise day, a meeting shall be held between the UIM Commissioner and the race organisers/officials, and the promoter (if any) to review all aspects of the race organisation. Time for the meeting will be at 18.00, unless otherwise agreed.
3. He/she is the voting member of the Jury. In case of two UIM Sports Commissioners, only one is voting member of the Jury.
4. Must meet the OOD and Jury Chairman
5. Must ensure a Jury meeting is held promptly and any penalty is imposed according to UIM rules.
6. He/she approves last minute amendments to the advance programme
7. Before the first drivers' briefing, he/she shall check with the race secretary that all paperwork has been done and verified confirm UIM rules and regulations:
8. Before the practice sessions and first drivers' briefing, he/she must check with the O.O.D. and Safety Officer the safety plan and check that all safety conditions are met.
  - the number and placement of buoys for the race course
  - the depth of the race course
  - the length of the race course, also taking into account the number of participants
  - the length of the start run to first turn buoy
  - the number and placement of rescue boats
  - the number and placement of tow boats
  - the presence of an ambulance close to the wet pits
  - the radio communication channels
  - the start procedure for the races
  - a plan covering bad water - or bad weather conditions (Offshore)

The UIM commissioner will be entitled to request that an event is suspended if safety conditions are not satisfactory. If the race is suspended, the UIM ceases to be responsible for any further race/heats and if it is a UIM titled event, then the results will be null and void. Further action may be taken against the relevant National Authority. The UIM Commissioner in conjunction with the O.O.D is entitled to take action with the race organizers if safety conditions are not met.

9. The UIM Sports Commissioner must be present at all official drivers' briefings. The UIM Commissioner will be presented to the teams and drivers by the O.O.D. at this first drivers' briefing together with the jury members.

It is recommended that the UIM Commissioner, address the teams at the drivers' briefing when he/she gets the chance, or visits the teams in the dry pits, to let the competitors know that he/she is there on behalf of the UIM and that he/she is open for any questions or remarks. He/she is there to help the local organizers, teams and drivers, with keeping in mind that the aim is to bring the sport to a higher international standard, in the spirit of the UIM code of ethics.

10. He/she ensures that UIM rules and regulations are adhered to.



11. The UIM Sports Commissioner assists the local organizers and he/she must be present in the race areas (dry pit, wet pit, race administration, race control) during all event days.
12. He/she takes part in important decision-making during the races with the O.O.D. and Safety Officer. The UIM Sports Commissioner should go with the O.O.D. to Race Control to have a good overview on the race, to follow the race control communications with the competitors and to be able to advise the O.O.D. and Safety Officer in urgent decision making or in emergency decisions.
13. He/she also takes part in urgent decision making with the O.O.D. and the organizing local promoter in matters related to the overall organization.
14. The UIM Sports Commissioner must, together with the O.O.D., sign and approve the provisional and official results issued by the official timekeepers, before these are posted on the notice board.
15. The UIM Sports Commissioner can handle misconduct together with the O.O.D. and give sanctions to a driver (UIM penalty cards). He/she should have authority and responsibility, in the spirit of the rules.
16. In case of a penalty cards, he/she should report this to the UIM in his/her report.
17. Must be present at the prize giving and shall present any UIM Medals to the winners unless a higher ranking UIM official is in attendance at the event.
18. The UIM Sports Commissioner can also be involved in alcohol and drug tests taken at the event, this in the frame work of the anti-doping regulations and abuse of alcohol. The UIM commissioner itself may always submit a competitor to an alcohol test if he/she thinks a competitor made abuse of alcohol. In case of announced official drug testing, the UIM Commissioner might have been informed by the UIM, as his/her assistance can be required.
19. In case of an accident, must keep all the information on the progress or otherwise of the injured persons and must send completed UIM accident report form to UIM as soon as possible.

20. After completion of the races, the UIM Commissioner must receive a copy of all classifications and documents to be transferred to UIM.

21. After the event, the UIM Commissioner must write a report by using the official form, as foreseen and drawn up by the relevant commission, and must send his report by e-mail to the UIM secretariat within 10 days after the event. He/she must include with his report the race map, the entry list, the results and any other documents that had importance for the event. Plus, photographs if possible.

The report from a UIM Commissioner is to be considered as confidential matter and cannot be used for aims other than UIM's, may not be communicated to the press or otherwise disclosed for any purpose whatsoever.

A copy of the report shall be sent by e-mail by the UIM office to the president and the members of the commission of the relevant race category and to the National Authority of the organizer. UIM Commissioners shall consider the races with the same standards, completed with own opinions.

Should any Commissioner fail to obtain all necessary data and results for transmission to UIM, he/she will note it in his/her report and will urge the organizers to send all required documents by themselves to the Secretariat of the UIM, as soon as possible.

## **2. Tasks and function of the UIM Technical Commissioner**

In case there is no UIM Technical Commissioner at the race, these tasks are taken by UIM Sports Commissioner.

The UIM Technical Commissioner is the representative from the UIM and his/her duties are very diverse:

1. He/she assists the local organizer and more particularly the Technical Officer and take part in important decisions in technical matters
2. Before the first drivers' briefing, he/she shall check with the race secretary that all measurement Certificates, log books cockpit documentation and homologations sheets for the boats and the engines are verified to confirm UIM rules and regulations by the technical scrutineers on at the event
3. He/she performs also inspections of the facilities and inspects the dry and the wet pits, this at any time before and during the event and observes if all security aspects on land are made.
  - placement of fire extinguishers
  - presence of the ambulance and personnel
  - placement of garbage/trash containers
  - placement of containers for waste of oil
  - safety of fueling area + presence of absorbing mats

4. He/she observes and verifies the application of the UIM Environmental Code as he/she has to take care that ground and water are protected. He/she will handle the environmental observations on titled events and include his/her observations in his/her report afterwards: he/she shall

- observe and verify the application of the Environmental Code
- inform the UIM sports commissioner and O.O.D. of any violation of the Environmental Code in order to pronounce sanctions relative to the infraction
- identify areas of good practice and make recommendations or proposals of modification to the Environmental Code

5. He/she ensures that UIM rules and regulations are adhered to and he/she is present in all pre- and post-race scrutineering and reports any finding to the UIM sport commissioner.

6. He/she assists the local organizers and he must be present in the race areas (dry pit, wet pit, race administration, race control) during all event days.

7. He/she handles the UIM ECUs

8. The legality of the fuel is solely under the judgement of the UIM Technical Commissioner, based on all tests made available to him/her.

9. He/she assists in reporting of incidents to UIM and in measurement certificates and log books

10. After the event, the UIM Technical Commissioner must write a report by using the official form, as foreseen and drawn up by the relevant commission, and must send his report by e-mail to the UIM secretariat within 10 days after the event. He/she must include with his report the results of all post-race scrutineering and any damage to boat or equipment during the races.

The report from a UIM Technical Commissioner shall be attached to the UIM Sport Commissioner report by the UIM Office. A copy of the report shall be sent by e-mail by the UIM office to the president and the members of the commission of the relevant race category and to the National Authority of the organizer. UIM Commissioners shall consider the races with the same standards, completed with own opinions.

### 3. Qualification of a UIM Commissioner

A UIM Commissioner must have at least a proven experience as a UIM race official or as a race official on a national level (e.g. O.O.D.), involved in the management of races, or involved in at least 5 race events.

Moreover, he or she

- must lead by example, be integer, promote the positive aspects of the sport and promote fair play
- must have very good knowledge of the rules and guidelines for the specific class he/she is appointed
- must be friendly and approachable, visible and accessible to the competitors and the local organizers (=present all day long each day of the event)
- must avoid conflict of interest
- must speak, understand and write good English (any other language is an asset)

The UIM Commissioner shall respect the UIM Code of Ethics, based on 5 Ethic pillars that impose obligations in terms of respect and responsibility to competitors, teams, promoters, officials and all other UIM accredited persons:

1. equality
2. fair play
3. respect
4. integrity
5. protection of environment

He/she shall use due care and diligence in fulfilling his/her role on behalf of the UIM and be an example in behavior at all times.

### 4. Application to become a UIM Commissioner

The National Authorities member of the U.I.M. are requested each year to send to the UIM secretariat a list of any new candidate commissioners with:

1. name and address of the person
2. e-mail address and mobile telephone number (and eventual fax number)
3. the languages spoken, read and understood
4. knowledge and experience in sports management, powerboating and technical matters

The complete list with candidate UIM Commissioners is afterwards sent by the UIM secretariat to the Presidents of the relative commissions, who appoint the UIM Commissioners for the international titled events.

## 5. Appointment of a UIM Commissioner

An UIM Commissioner shall be chosen by the Secretary General in coordination/ consultation with the chairperson of Cominoff, Cominsport or the relevant committee from the listings provided by National Authorities, Cominoff, Cominsport and by the relevant Committees.

An UIM Commissioner cannot be appointed to an event organized by his own National Authority, unless by reason of force majeure.

The UIM secretariat will then ask to the appointed person if he/she is available for the dates of the event and if he/she can represent the UIM on at the event.

Following the Commissioner's agreement, the secretary General of the UIM will send a letter by e-mail to the National Authority and the organizers of the event, informing them that a UIM Commissioner has been appointed for the event referred to in the letter, and the UIM will transmit all coordinates of this UIM Commissioner to the N.A. and organizers of the event.

The local organizers will contact with the UIM Commissioner as regarding to traveling and stay and will send the Advance Programme in due time to the UIM secretariat and the UIM Commissioner.

The UIM will also supply clothing as shirts, polo and jacket to the UIM Commissioner, the first time when he/she is appointed or whenever new clothing has been foreseen for UIM Commissioners.

## 6. Tools of a UIM Commissioner

The UIM Commissioner can fall back on the rules and regulations from the UIM, included in the respective rulebooks as for different categories, and on the written race instructions for the event.

Rules always can be improved, and out of the experience during the races, it is good to report in his/her Commissioner's report where rules fail or where rules are not clear or complete enough. So, the UIM Commissioner can make recommendations on rule changes or point out where rules fail, in order that this can be taken into account for new or modifying rule proposals.

## 7. Accommodation and reimbursement of travel expenses

The national authority of the event must remind the local organizers at their obligations:

1. to accommodate the UIM Commissioner in a good hotel for the whole duration of the event and as long as is required for the accomplishment of his/her mission at the expense of the organisers.
2. to bear the travel expenses from town of residence to the place where the event takes place. If the UIM Commissioner has bought self his/her ticket, the costs should immediately be reimbursed in cash during the event days. A cost of 0,35 Euro can be calculated per km for traveling by car to the airport. A return ticket, economy class, is also borne by the organizers. Also parking costs at the airport must be reimbursed.
3. to provide daily meals to the UIM Commissioner or give him a per diem (a fix amount per event day) for food and drinks. If the organisers do not offer daily meals and local transportation to the Commissioner, they must be paid minimum of 30 euro per day.
4. to provide local transportation for the whole duration of the event, if necessary.

The UIM must ensure that the travel expenses are paid. Air, rail and/or road travel expenses are to be granted at economy rates. The expenses stated above must be refunded to the Commissioner by the local event organizer, or if not, by the UIM within 30 days of receipt of vouchers. Reimbursement shall be done by the organisers directly to the Commissioner prior to departure. If the organisers fail to do so, the Commissioner shall invoice the UIM. The UIM then sends the organisers' National Authority an equivalent invoice, adding a 10% surcharge. The invoice must be settled to the UIM within 30 days.

## **200 - RACE ORGANISATION**

### **200.01 – GENERAL**

The following bodies have the right to organise any power motor-boating event: National Authorities and their Affiliated Clubs, Corresponding Members of the UIM, UIM contracted promoters (with the agreement of the National Authority).

All events have to be sanctioned by the National Authority. For events taking place in more than one country, each country's NA must approve the event.

Affiliation to the National Authority implies acceptance of the National Rules and those of the UIM.

A club, member or driver who is suspended, is not allowed to take part in any power boating event in his country, or in any other country neither as a driver nor as an official, as long as the suspension lasts.

A member or a driver who takes part in any power boat race in a foreign country affiliated to the UIM, undertakes ipso facto to abide by the rules of the National Authority of that country.

All clubs, race organisers, officials and drivers are obliged to know the general rules of the UIM as well as the rules related to races or series (local, National or International).

The current version of the UIM Rule Book must be made available for consultation at every race (either in digital version or in a hard copy provided by the race organiser).

All International races organised by National Authorities or their affiliated clubs must be organised in accordance with the UIM rules. All advance programmes and racing instructions must mention this.

The general racing rules and the rules related to records are applicable to all the International series.

### **200.02 - INTERPRETATION OF THE RULES**

In all cases not foreseen by the International rules or seemingly inaccurately defined, the National Authority, Race Committee, Race Jury or the Appeal Board, is to judge bearing in mind the intention and the spirit of the disputed rule.

The rules for series and classes are to be considered as being supplementary to the general Sport rules.

In case of conflicting rules, those concerning a specific case/occasion (i.e. series and classes) are to prevail over the general rules.

National Authorities may impose special event rules relating to exceptional local requirements for National events or International events including World or Continental Championships. These special event rules prevail over, but must not conflict with the UIM Sport rules.

English is the working language.

## **201 - ORGANISING BODIES**

### **201.01 - RACE COMMITTEE**

All races are under control of the organising club who is to nominate:

- An Organising Committee which organises the general and administrative aspects of the meeting;
- A Race Committee which organises and supervises the actual racing and decides whether competitors are eligible or not.

The Race Committee is composed as follows: the Officer of the Day, the Deputy Officer of the day, the Medical Officer, the Race Secretary, the Technical Officers.

The decisions of the Race Committee and the Jury must be based upon the UIM rules, but as no rules can be devised capable of covering every case, the race committee and the Jury must discourage all attempts to win by means other than fair racing, superior speed and skill.

The organising committee appoints a Committee that verifies all the documents required i.e. Measurement

Certificates, Driving Licence, etc.

This Committee also verifies whether or not the boats and motors conform to the rules.

No officer, nor member of the Jury, nor member of a National or International Committee or Commission, is allowed to intervene in the judgement of a problem in which he is involved himself or is an interested party (See rule 402.01).

The following are the Race Officials:

1. The Officer of the Day;
2. The Deputy Officer of the day;
3. The Medical Officer;
4. The Secretary of the Race Committee;
5. The Technical Officers;
6. The Course and Buoy Officers;
7. The Timekeepers and Starter;
8. The Lap Scorers;
9. The Jetty Marshall.

#### **10. The International Jury Chairman**

### **201.02 - INTERNATIONAL OFFICERS LISTS**

Lists of International Officers of the days and of International Jury Chairman are deposited in the Secretariat of the UIM.

Every year, each National Authority has to transmit the Secretariat its new list of O.O.D. and I.J.C. or the confirmation of the previous year's one not later than September 30th.

Each National Authority may propose for enrolment in the list of O.O.D. and I.J.C. only those race Officers that have been regularly qualified by said National Authority.

Requirements for the enrolment of a candidate:

- a) a personal record (containing personal data, address, telephone, fax, numbers and/or e-mail)
- b) knowledge of English
- c) the NA of the relevant candidate for O.O.D. and I.J.C. must be satisfied they have had sufficient experience to officiate at a UIM International event.

Only people enrolled in the UIM lists are allowed to be appointed to the charges mentioned above and therefore to be appointed by their National Authority to perform such duties in international races valid for UIM titles.

### **201.03 - THE OFFICER OF THE DAY (O.O.D.)**

The Officer of the Day must supervise the organisation of the races on behalf of the Organising Club. He must maintain order on the course, ascertain that all services work properly, ensure that all correspond to the rules and observe the Racing Rules according to the Programme, gather written reports of the Officers and Timekeepers and any other documents that will enable the results to be compiled.

### **201.04 - THE DEPUTY OFFICER OF THE DAY (D.O.O.D.)**

The Deputy Officer of the day co-ordinates (together with the Officer of the day) the safety services on shore (fire) as well as on the water (boats, people on board, material). When necessary he stands in for the Officer of the day.

### 201.04.01 - THE MEDICAL OFFICER

The Chief Medical Officer is responsible for the medical organisation in the racing area, on shore as well as on the water.

In agreement with the Officer of the day and his deputy, he controls the order of the means of emergency such as life-boats, ambulances, mobile reanimation unit, an eventual airborne ambulance and the first aid station. In case of intervention on the water, he will take command of the rescue operation following stopping of the race by the Officer of the day.

### 201.05 - THE RACE SECRETARY

The Race Secretary is responsible on behalf of the O.O.D. for the practical side of the meeting and organisation and must satisfy himself that the various officials know their respective duties and that they have all the necessary documents and equipment. He must collect all documents.

### 201.06 - DUTIES OF THE RACE OFFICIALS

The Race Officials shall perform only the duties with which they are entrusted.

### 201.07 - THE TECHNICAL OFFICERS

The Technical Officers are to make sure that all drivers have their Measurement Certificates and shall verify that the hull and engine conform to the certificate and rules.

They check and control safety devices for boats and drivers as provided for in the rules **and must inform the O.O.D in writing about all irregularities before the boats go on the water. The O.O.D. will enforce the rules when needed.** They verify the synchronisation of the clock and the camera if used.

After the race, they must do all necessary checks, all infringement must be communicated in writing to the O.O.D.

### 201.08 - THE BUOY AND COURSE OFFICERS

They must ensure that the drivers conform to the racing rules. Any irregularities must immediately be reported to the O.O.D. by radio, and in writing following the event, the O.O.D. will enforce the rules when needed. Buoy and course officials are allowed to be in boats. If they cannot be in boats inside the circuit, there will be two of them: one at the entrance and one at the exit of each turn.

### 201.09 - THE TIMEKEEPERS AND STARTER

The Timekeepers will:

- calculate on completion the elapsed time of each drivers;
- establish the finishing order after having made all necessary calculations and establish the average speeds;
- for international races there must be at least two timekeepers. Their results must only be handed to the Officer of the Day;
- the starter signals the start when ordered to do so by the Officer of the Day.

## **202 - ADVANCE-PROGRAMME**

### **202.01 - FORWARDING DATE**

90 days before any international race the organising committee must forward at least one advance-programme to the UIM Secretariat who will have it examined for completeness and correctness within 30 days and to be subsequently published on the UIM website. The advance-program will also be forwarded to the commissioners for recommendations.

Should the 90 days delay not be complied with, the calendar fee will be double.

### **202.02 - INFORMATION IN ADVANCE PROGRAMME**

The above advance-programme must be written in English and in the language of the organising country if necessary. In case of conflict between two versions of languages, English version prevails. Advance Programme must contain the following information:

- 202.02.01 the name and the address of the organiser;
- 202.02.02 the series and classes of boats catered for;
- 202.02.03 the race or races which will be run;
- 202.02.04 the venue and the date of the race(s);
- 202.02.05 the course of each race and plan drawn to scale showing all details as per rule 106.02. Start method, flying start or dead engine start, and maximum numbers of boats on the course;
- 202.02.06 The races are held under the UIM rules;
- 202.02.07 The special conditions which in accordance with the UIM rules may be added or modified;
- 202.02.08 Time limit and place to which entries must be sent, and whether written, by fax, by email or by hand;
- 202.02.09 The amount of the entry fee, (For **a** Continental or World Championships **of any circuit class, it may not exceed 100€ for each entry.**
- 202.02.10 All information regarding the prizes for each race;
- 202.02.11 An entry form must be included in the advance programme. Where and when racing instructions can be obtained;
- 202.02.12 Transport facilities and concessions;
- 202.02.13 Terms and conditions of a mandatory insurance for personal and material damage to third parties, competitors included;
  - The minimum limit of coverages required;
  - The quality of risks to be covered by the insurance;
  - Whether insurances from other National Authorities are authorised and if they are, in which language they must be drawn up; All insurances produced by visiting Nationality drivers must also be written in English as well as their native language to be accepted and authorized.
  - The amount of insurance fees to be paid on the spot (90 E maximum);
- 202.02.14 Minimum age of competitors;
- 202.02.15 Times for practice per class and the interval between the heats;
- 202.02.16 Full instructions regarding noise regulations;
- 202.02.17 Date and times for scrutineering;
- 202.02.18 Number of the heats and number of the laps for each category at race;
- 202.02.19 Number of laps in case of the qualification heats;
- 202.02.20 The time limits for late starters and finishers;
- 202.02.21 Place and time of the drivers meeting;
- 202.02.22 The protest fee. (maximum 80 euro);

- 202.02.23** Should no publicity be allowed during a race, this is to be mentioned in the advance-programme;
- 202.02.24** Each organizer who imposes on all drivers the application of a sticker (max measures 30 x 10 cm) of their own sponsors on each side of the boat, must write that in the advance-program;
- 202.02.25** Organisers must announce if they will supply fuel at the meeting, at what price, and to what manufacturing specification and octane rating (508.01);
- 202.02.26** All equipment required by the Race Committee that the boat must have onboard during the race;
- 202.02.27** The cost of the buoy destroyed (maximum 200 €);
- 202.02.28** Time delay for late starters, after what starting is not allowed, in the case of endurance or long distance races;
- 202.02.29** Internet web-page address , where results of the race can be followed operatively and downloading link, where results from every heat and race photos (minimum 10) from every race day are downloadable for press.

### **202.03 - ADDITIONAL REQUIREMENTS**

- 202.03.01** There must be no financial penalties justified in any race advance programme or initiated at the race site that are not fixed within the UIM Rules, including those from Rule 101.01 up to Rule 905.42;
- 202.03.02** No modifications are to be made to any particular rule after the advance-programme is posted except if decided by the Race Committee and for cases of force majeure only;  
The modifications must be communicated, by written means, to the officials and participants, at least 1 hour before the first start.

## **203 - ENTRIES**

### **203.01 - RATIFICATION**

The National Authorities must ratify in writing any entry for drivers wishing to race abroad.

Direct correspondence between the organising committee and foreign drivers is permitted but no entry is to be accepted unless authorized in writing by the driver's National Authority.

The Organising Committee will keep blank entry forms at the disposal of the drivers.

An entry is not valid unless it reaches the organising committee within the time prescribed in the advance programme. In case of World Championship and Continental Championship race entries can be done at the race office at times of registration defined in the race Advance Program. However in this case driver with late entry may not get travel and prize money. Additionally late entry driver(s) may not be allowed to keep his boat race number as per rule 206.02.

### **203.02 - ADMISSION**

No organiser, organising an international race has the right to refuse the entry of a foreign driver duly commissioned by his own National Authority provided said driver conforms to UIM rules.

Drivers need only to supply such particulars as are applicable to the class of their boat.

However, if a driver wishes to enter a boat with a reinforced cockpit (rule 509) in a class where a reinforced cockpit is not mandatory he must mention this in his entry. Acceptance of the entry then binds the organiser to provide the proper rescue facilities as per rule 205.08.

No entry shall be considered accepted until the boat has passed scrutineering and the documents are checked.

Only one boat per driver is allowed to be entered for any championship meeting. Spare hulls and engines are allowed but may only be used as foreseen in the rules.

For the PR classes, the same boat can be used by several drivers racing in different heats, with the individual driver's racing number, affixed to the boat for his heat(s).



### 203.03 - ENTRY FEE

Each organising committee fixes the amount of entry fee for the races. Entry is valid only after payment of the entry fee.

The National Authorities have the right to establish a rule whereby higher fees are imposed on late entries.

In case of titled events, ***the amount of the entry fee, for a Continental or World Championship of any circuit class, may not exceed 100€ for each entry. It must be indicated in Advance Programme documents.***

### 203.04 - MINIMUM AGE

Each National Authority has the right to fix a minimum age for the drivers allowed to race on its waters. Such age restriction is to be shown in the advance programme.

No National Authority can sanction a UIM titled event if their minimum age restrictions do not allow drivers with the UIM minimum age for the relevant classes (rule 203.041).

#### 203.04.01 - MINIMUM AGE INTERNATIONAL AND EXPERIENCE INTERNATIONAL

The minimum age for all drivers racing international races is 16 years. For racing in the classes S-P-T up to 400 cc, EH-15, the minimum age is 14 years (by the race date).

Drivers allowed to race in the class JT250 and GT15 must be 10 years of age (by the race date) and may complete the race season in which they reach 16 years of age.

Drivers allowed to race in the class ET-15 must be 10 years of age (by the race date).

Minimum age of drivers allowed to race in class Formula Future is listed under 960 pt 1.1.

### 203.05 - NATIONALITY

Only the nationality shown on the drivers' licences must be taken into consideration in the classification and for any flags affixed to the boat.

### 203.06 - PUBLICITY ON THE BOATS

Advertisements may be freely applied on the entire surface of the boat, but there must be a free distance of space around the boat number according to the rules of "Race numbers".

No owner or crew can be compelled to carry any advertising whatsoever on their person, clothes or upon the boat that is being raced and his/their refusal to do so cannot in any way be an obstacle to their participation in any race. If an entrant refuses to display sponsor advertising, this must be noted on his entry application.

Penalties may be applied to any driver who, in the course of any sporting event, has made any advertisement contrary to the truth or distorting the facts. Political publicity or immoral advertisements are not allowed.

Should restricted publicity or no publicity be allowed for an event, this must be announced in the advance programme.

Any National Authority has the right to fix its own rules regarding publicity for its own boats and venues.

## 204 - RACE INSTRUCTIONS

### 204.01 - ORGANISING COMMITTEE MEETING

On the day prior to the first race/practise day, a meeting shall be held between the UIM Commissioner and the race organisers/officials, and the promoter (if any), to review all aspects of the race organisation. Time for the meeting will be at 18.00, unless otherwise agreed.

## 204.02 - DRIVERS MEETING

### DRIVERS' BRIEFING

#### 1 RACE BRIEFING FOR COMPETITORS

These meetings should be held in English. If the meeting is not in English a full and immediate translation into English must be made by an Interpreter.

Any instruction not infringing the actual rules and specific to the venue, given by the OOD, becomes obligatory for the drivers and race officials to follow. Not abiding by these instructions may involve penalties being applied.

The Drivers' Briefing is an extremely important part of the race event and the OOD must ensure that all relevant information is conveyed to the competitors during this process. The OOD must check that all competitors are in possession of the Race Instructions and any Bulletins issued as these will provide comprehensive information of the event. It is mandatory for all competitors to attend all Drivers' Briefings for their class, failure to do so may lead to disqualification. A guide to the format of a Drivers' Briefing is set out below.

#### 2 BRIEFING PRESENTATIONAL MECHANICS

The briefing area should be in an appropriate location away from distractions and not within a public area such as a bar. The area should be set up completely prior to the briefing taking place, including ensuring there is the correct number of seats etc. All the appropriate equipment should be in place and correctly configured; this equipment includes the P.A. system, large chart of the course, notice boards and audio/visual apparatus. It is recommended that the briefings are recorded.

Entry to the area should be strictly controlled; only drivers, National Team delegates and other relevant personnel should be allowed to attend.

- The OOD must properly prepare for the Briefing. It is important to stick to the template to maintain structure and flow. (See below.)
- Keep control of the Briefing.  
Ask for mobile phones to be switched off or silenced. Ensure questions are held back until the end and minimised.
- Be brief and concise.

#### BRIEFING TEMPLATE

1	Welcome	Competitors-VIPs-Sponsors-UIM Authorities-Local NA Authorities
2	Attendance	Check Signing in sheet for absentees. Only use roll-call if all else fails.
3	Introductions	Self – UIM Commissioner, Deputy OOD, Rescue Officer, Doctor/Paramedic.
4	Advance	Confirm everyone has received copy/is currently in Programme/ possession of/has read/understood. Race Instructions Jury Composition :The Jury Composition will be announced at the first drivers meeting. The Jury must be present at the first drivers meeting.
5	Race Bulletin/s	Confirm everyone has received and understood.
6	Weather Report	Advise of wind/water conditions.
7	Timetable	Running to timings. Highlight delays or changes.
8	Environment (700 group Rules)	Absorbent Carpet Pay attention during refuelling. Advise if re-fuelling allowed on jetty. Waste ~ Bins/Bags provide? Leave your area clean ~ Take waste home with you
9	Launching	Highlight timings for individual classes and procedures. Highlight hard hats in crane area.

10	Race Course	Highlight any changes to Advance Programme/Race Instructions. Turn buoys Entrance/Exit to course. Feed In/Feed Out Buoys. Start Jetty/Procedure for start of race/late starters. Procedure for Training. Number of laps Finish procedure
11	Stopping of Race & Re-starts	Only OOD may stop race Red Flag/Flares Restart procedure Racing in Heats Less than 70% re-start Number of laps Jetty positions. Points for re-started race. Final heat second restart – Full points. Single Heat Race If 20% of race remaining. Laps from original and all restarts aggregated for final positions.
12	Safety Coverage	Rescue boats Tow Boats Procedures
	Flags	Red Yellow
13	Alcohol &	Saturday/Sunday? Drug Tests
14	Information	Cost of Damaged Buoys Any local regulations No smoking Other Facilities available on site Any Social functions.
15	Podium Procedure	
16	ANY QUESTIONS ?	
17	Time Check	
18	Conclusion	Thanks to all & 'safe racing' message.

## **205 - SAFETY RULES**

### **205.01 - ANNUAL MEDICAL EXAMINATION**

Each National Authority must submit all drivers under its jurisdiction to an annual medical examination and where applicable, an immersion training annually.

Each National Authority must adopt a form to be used for the medical examination to which every driver who competes Internationally must be submitted every year.

Each National Authority must submit to a special examination any handicapped driver, any driver who has had a serious accident, or any driver who during two or three races has shown odd behaviour when driving his boat. This check is compulsory before participation in an International race and must be certified by a commission appointed by the National Authority of the interested driver. The commission will be composed of a well known medical specialist and two other experienced racing administrators who are members of the National Authority. The commission may give or refuse authorisation as to the eligibility of the driver(s).

Each National Authority which organises an international race must abide by the regulations approved by Cominsafe regarding the medical organisation of international races.

## 205.02 - MEDICAL EXAMINATION AT EVENT

The Chief Medical Officer who is to be present at any event has the right to submit any participating driver to psycho-physical examination and this at any time during the event, an alcohol or drug test may be performed.

The result of such examination is immediately communicated to the Race Committee who basing themselves on the report of the medical officer, may suspend the driver from the competition.

Following any accident, the driver must undergo a physical examination and be passed fit by the event medical staff before being permitted to continue in that racing event.

Following any accident, damaged boats must be completely rechecked and approved by the official scrutineer and the UIM Commissioner, before being permitted to re-join the event.

### 205.02.02 - TEST ON CONSUMPTION OF ALCOHOL

Competitors, **team members and officials** shall not be under the influence of alcohol **during the entire racing event**.

Testing when carried out shall be by using an alcoholmeter.

A competitor, **team member or official** shall, if requested by an authorised official, submit to an alcohol test. Written **or verbal** notification of selection for testing will be **given to selected person** by an authorised official. Refusal or failure to do so **in time limit 15 minutes from notification** may be taken as if a positive test had been ordered and dealt with accordingly.

For all International races, any competitor found to have more than 0.00 micrograms of alcohol in 100 milliliters of blood (0.00 on the breath analyzing machine) 1 hour before or during testing or racing shall be immediately suspended and disqualified from the whole event, except if the event is more than one day in which case the OOD/UIM Commissioner may order another test.

**For all international races, any team member or official found to have more than 0.00 micrograms of alcohol in 100 milliliters of blood (0.00 on the breath analyzing machine) shall not be allowed in any area under the control of the race officials.**

The results and any penalties are to be transmitted to the UIM; and to the National Authority (NA) of the driver's license, and the UIM NA of his passport, for further sanctions.

### 205.02.03 - ANTI-DOPING REGULATIONS

Anti-doping regulations based upon the world anti-doping code.

See separate section in this rulebook.

## 205.05 - IMMERSION TRAINING

Before racing in a craft with restraint systems, all crews must have passed in the last fourteen months, an immersion training in a restraint system to ensure that they can exit a reinforced cockpit crew compartment successfully.

Prior to taking the Immersion training, all onboard crews must have a valid scuba certificate or have received suitable training.

This alternative training should be approved by the National Authority.

It is mandatory to wear a Frontal Head Restraint (FHR) device during the Cockpit Evacuation / Immersion Training. Self-removal of an FHR forms part of the Immersion test training.

An immersion Certificate to certify the passed test, showing the expiry date, not to exceed fourteen months, must be delivered by experts recognised by a National Authority.

All riding crew members using restraints must sign the National indemnity form prior to competing in any race or practice.

A model for the certificate and instructions of how to perform immersion training are available at the UIM Secretariat.

## 205.06 – RACING VEST

Each person aboard a race boat must wear an efficient racing vest during the race and practice conforming with the following rules:

The choice and efficiency of a Racing vest is the sole responsibility of the wearer and must be in conformity with following criteria;

Buoyancy: a life jacket must have a minimum of 75N solid buoyancy for a person weighing up to 60 kg and 100N solid buoyancy for those over 60 kg (closed cells foam only);

The disposition of the solid buoyancy is intended to ensure that an unconscious person shall float face up in the water;

All adjustable straps must be at least 40 mm wide and have a minimum breaking strain of 10 000N. The crutch straps must be attached at the front at the position of iliac crest and at the back in the sacral region. A recovering attachment must be placed either on the shoulders, or as a chest strap and made with strap of the same quality as indicated above;

The Racing vest must at least be colored with 70% of highly visible orange, red or yellow;

The back must include a protective plate.

The compulsory collar must have rounded edges and extend above the bottom of the helmet. It must not exceed 180 degrees;

A Racing vest manufacturer must undertake to comply with the rules and print indelibly on the Racing vest the following : "conforms with the regulation for a person weighing a maximum of 60 kg" or "for a person weighing over 60 kg", in respect of the buoyancy.

Race organisers are required to repeat this important clause in the Advance Programme and the Race instructions. For boats with canopies, refer to rule Offshore §508.25/Circuit §509.04

## 205.07 - PROTECTING HELMET (except Formula Future and Solar Racing)

Any person aboard any boat taking part in races must wear a helmet which complies with the SNELL, or FIA helmet standards in accordance with the list available on the UIM Website.

At least the upper 50 % (area) must be of bright red, bright yellow or bright orange colour. It is highly recommended that these colors are fluorescent, especially in non cockpit boats so they can be clearly visible in the water.

No image recording device, however small, may be attached to helmets. The wearer is entirely responsible for the efficiency, including the fitting, of his helmet. All organisers should repeat this rule in any relevant issued documents, written or verbal.

### 205.07.01 - FRONTAL HEAD RESTRAINT (FHR)

It is mandatory for all restrained competitors to wear a Frontal Head Restraint (FHR) system that complies with SFI38.1 or FIA 8858 standards,

Quick release fixing posts that disconnect the device via a 'tab pull system' for FHR's are mandatory.

It is the responsibility of the wearer to ensure that the FHR device that they are using is suitable for the application that they will be wearing it for and consideration of use should be given to FHR devices that are : easy to release, have a low upright section at the back of the head.

It is also mandatory to wear your FHR device during your Cockpit Evacuation / Immersion Training. Disconnection of an FHR before attempting to exit a cockpit forms a part of the Immersion test training.

### 205.07.02 - OUTSIDE ASSISTANCE - RADIO

No person shall provide or receive outside assistance by radio/electronic communication, during the race in circuit classes except any UIM Classes where it is necessary for safety reasons/UIM Rules and officially authorised, including FR-1000, S1, S2, S3, F500,F4, F2, F1.

### 205.07.03 OUTSIDE ASSISTANCE – TELEMETRY

Any data communication via telemetry or similar means must only be from the boat to a shore station. No data is to be sent from shore to a boat during competition

## 205.08 - SAFETY BOATS

A sufficient number of safety boats must be on station and in position during all official on-water activity at an event.

There should be a minimum of one Doctor or Paramedic who is experienced in handling trauma (PHTLS Pre-Hospital Trauma Life Support concept or equal) present on at least one of the safety boats. The doctor or Paramedic cannot be counted as a Diver or any other member of required boat crew. Alternatively where appropriate a Doctor or Paramedic can be stationed in a different position to allow them to be transported to a casualty via other means of transport i.e. Air Ambulance.

Each safety boat must have the following crew on-board as a minimum: 1 X Boat Driver & 2 X Divers who are equipped to enter the water immediately when required to begin a recovery procedure of a casualty or boat. At least one member of crew on-board should have basic First Aid training and be capable of providing basic life support assistance to a casualty.

Radio contact between safety boats & Officials is mandatory.

At least 2 of the Safety boats situated on a course shall have either a Crane or 2 X Lifting Bags that are capable of supporting a boat to assist in keeping a cockpit above the surface with a competitor inside. Lifting bags are also highly recommended for use to assist in the recovery of a stricken boat.

All safety boat crews should be familiar with the safety equipment used by competitors and know how to remove equipment from an injured casualty. Particular attention needs to be paid to the ability to remove Frontal Head Restraints (FHR) before attempting to remove a casualty from a cockpit, along with knowledge of Restraint Harness Removal, Helmet Removal and how canopy releases systems or extraction points operate.

Each safety boat must be capable of taking on-board a casualty on a stretcher with minimal movement / disturbance to the casualty. The crew will recover all casualties onto the safety boat using a rigid stretcher.

Each Safety boat must be sufficiently powered to reach incidents as soon as possible and should be well-maintained and fueled, with the engine of the safety boat should be running during racing/training period.

All safety boats should carry the following:

A stretcher that is capable of floating in the water and capable of dealing with spinal injuries.

Equipment for handling; airway, external haemorrhage, neck/back injuries.

A Minimum of basic First Aid Equipment that must include: large sterile dressings, a Neck Collar and a Resuscitation Mask.

Equipment for cutting belts / straps and cut-resistant clothing.

It is highly recommended that an extra breathing air bottle of sufficient capacity is carried on-board to provide air support to the Dive Crew or a Casualty who may need it. Quick connect-valves should be used.

2 X Lifting Bags that are capable of assist in keeping a cockpit above the surface of the water. A fire extinguisher with a minimum capacity of 2ltrs must be carried.

A Minimum of 2 x Towing Ropes with Carabiner hooks must be carried on-board. A full set of racing flags should be carried as described in the rules.

A minimum of 2 radios to maintain contact with shore / Race Officials.

### 205.08.01 - TOWING BOATS

There must be a minimum of 4 Towing Boats on station to cover circuits up to 2000 meters, or as specified by the Water Registration. Larger Courses should have their patrol boat numbers increased by 1 boat for up to each additional 500 meters. i.e. a Circuit of 2500 meters should have 5 Towing Boats on station, or as specified by the Water Registration.

Each towing boat must be crewed by a minimum on 2 people.

Each towing Boat must be sufficiently powered to reach incidents as soon as possible and be well maintained and fueled.

All towing boats should be prepared to tow/recover boats to shore with their engine running during all racing or training, with their engines running during on water activities.

In addition to tow duties, all boats must inspect the course and remove any floating debris before the race start, the race course will be monitored for floating debris entering the course during the race.

Use of PWCs as part of the required number of Patrol Towing boats is authorized and may be crewed by only one person.

All towing boats should carry the following equipment: Equipment for cutting ropes etc.

fire extinguisher with a minimum capacity of 2ltrs must be carried.

A Minimum of 2 x Towing Ropes with Carabiner hooks must be carried on-board. A full set of racing flags should be carried as described in the rules.

1 X radio to maintain contact with shore / Race Officials.

### **205.08.02 - FIRST AID STATION**

A First Aid Station with qualified medical attendants and a suitably equipped Ambulance must be stationed in an appropriate position at an on-shore location. The location must be suitable for casualties to be easily transferred from the safety boat to the care of medical professionals.

A mobile resuscitation unit must be available as well as all other necessary equipment to provide treatment and deal with serious trauma.

At least one fully qualified Doctor or Paramedic must be positioned at the First Aid Station and be prepared to receive casualties. The Doctor or Paramedic in attendance should have training or experience in Advanced Life Support / (PHTLS Pre-Hospital Trauma Life Support concept or equal)

It is highly recommended that the First Aid Station is equipped to receive multiple casualties.

### **205.09 - INSURANCE**

All drivers must be properly insured for personal [AD&D] injury and against third party claims, either by themselves, with the policy to be produced before the start by an insurance covered by the National Authority or the race organizer, the fee being paid by the driver.

Only if a driver is not insured against third party liability claims by his National Authority or if the coverage of this insurance is insufficient or if the driver cannot show the confirmation of the National Authority an insurance against third party liability claims must be bought at the race meeting.

UIM should supply a third part insurance for those NA's that can't find a solution in their own country.

The total cost must be stated in the advance-programme. The cost of such insurance to the driver must not exceed 90 €.

In case of buying insurance at the race meeting drivers must receive a copy of the insurance certificate with an English translation and a receipt of paying for insurance. Insurance certificate should define coverage of insurance. Event organizers are responsible of reliability of insurance company.

Do not underestimate your responsibility in accidents occurring during official trials before the verification of the boats and the various documents required. Only verification will make it possible for you to be sure that the driver is insured properly.

### **205.10 - TECHNICAL PROTECTION**

It is forbidden to start the engine with any items on the propeller shaft, except in the following case.

Each engine must have a propeller guard in place whenever a propeller is installed except when in the process of launching. Non-compliance results in disqualification from the relevant heat.

When launching of a boat whose cylinder capacity is more than 750 cc, it is forbidden to start the motor or the engine with the afterpart of the boat lifted up and the propeller rotating. If it is necessary in order to start a boat of less than 750 cc to lift it up, efforts must be made to protect the person(s) who launch the boat.

### **205.11 - CLOTHING PROTECTION (except Formula Future and Solar Racing)**

It is mandatory that cut resistant clothing of fabric that satisfies a minimum cut resistant Level C by EN 388:2016 or minimum cut resistant Level A3 by ANSI/ISEA 105-16, or of a minimum cut resistance of 10 N using the test process specified in EN ISO 13997:1999 be worn by all participants in all boats without reinforced cockpits.

All limbs of drivers in both reinforced and non-reinforced cockpits must be covered. A one-piece overall suit must be worn in reinforced cockpits.

### **205.12 - LIFTING OF RACEBOATS**

Boats intended to be craned in and out of the water, must have slings and hooks certified to lift minimum the double of the minimum boat weight.

The certification must be located on the slings and the hooks. All hooks used for lifting raceboats must be a closed hook type.

Lifting eyes on the raceboat must be bolted through the construction of the boat, with minimum 8 mm bolts and washers of at least 10 square centimeters area per lifting point.

No boat shall be lifted over people. Lifting a boat with a person on board other than for weighing will disqualify that boat and it's driver.

No boat can be lifted higher than 0.5 m from the boat's trailer or the ground/water with any person on board, while weighing.

### **205.13 - TESTING**

Testing outside the race circuit and before or after the authorised hours is prohibited during the event.

### **205.14 - ACCIDENT REVIEW BOARD**

At the request of the UIM Commissioner at an event or after a fatality, an Accident Review Board set up by Cominsafe must conduct a review. This review may consist of interviews with pertinent and appropriate parties, examination of the relevant racing equipment, review of relevant reports, etc. in order to determine as much useful information as possible. A report of the findings will be filed with UIM and may be used as the basis for rule changes.

## **206 - NATIONALITY AND RACE NUMBERS**

### **206.01- NATIONAL FLAG**

The national flag, painted in a rectangle 25 cm x 40 cm minimum on the deck, the hood, or the vertical part of both sides of the hull: this flag should remain visible during the whole race. The national flag should show the nationality of the drivers license.

### **206.02 - NUMBERS**

A race number is allocated to every driver by his National Authority.

Race number "1" in each class is reserved to the reigning World Champion.

Should two drivers of an international competition have the same number:

- 1) the driver of the inviting nation will change his number following the instructions of the Technical officer.
- 2) If none of the drivers is from the organising nation, the driver who entered last will change his number following the instructions of the Technical Officer.

In case of an electronic registration, online or by email, the race organizer must inform the driver if a change of his race number is required within three calendar days from receipt of his registration form.

The race number may be fixed:



- 1) on a surface corresponding to the following measures and characteristics: the surface measures 32 x 40 cm and the numbers must be black on a white surface on both sides of the hull in digits of 24 x 14 cm.
- 2) For F1 and F2: On a surface corresponding to the following measures and characteristics: the odd numbers must be black on a yellow fluorescent surface, the even numbers must be black on an orange fluorescent surface, the third boat of the team the numbers must be black on white on both sides of the hull. All numbers must be 24/14cm.

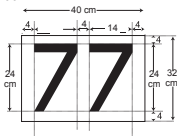
The width of the stroke of the number should be at least 4 cm.

The space between the rectangular with the digits must be 4 cm.

The white surface must surround the digits with 4 cm.

All numbers must be plain and upright (no italics). No number shall begin with zero, e.g. for 2 digit numbers (sketch as shown below):

Exception - P750 to comply with rule 561.09



In case of a 3 digit numbers, the length of the surface must be modified consequently.

- 2) the race numbers may also be painted or glued to the slightly curved surfaces and on one vertical surfaces provided that the whole number is within 30 degrees from the vertical position.

It is recommended to use two digits only.

The race number must remain visible during the whole race.

**Every boat must have start number fixed to flat part of its deck, or cowlings in the front part for better identification by drone video.**

There must no advertising within a of space of no less than 0,15 meter around the boat number.

## 206.03 - LOSS OF RACE NUMBER

The absence of the race number or part of that race number leads to the disqualification of that boat from that heat only.

## 206.04 - UIM STICKERS

The UIM actual logo, minimum 20 cm in length stickers, supplied by the UIM or other manufacturer, must be attached to both sides on a near vertical surface, of all boats participating in UIM titled events. The loss of the UIM logo will not be a reason for disqualification at post race technical inspection.

## 207 - DISCLAIMER

By participating in UIM governed races any participant (driver, team member, spectator, race official or other involved person) acknowledges the following:

UIM is the governing rule making body of UIM racing events which are responsibly organized by clubs, national authorities of UIM, contracted promoters or other organizers. These organizers do not act on behalf of the UIM and UIM is not responsible for any act or omission of such organizer and shall not be liable to the participant accordingly.

The UIM sport and technical rules are intended to minimize risks but they cannot provide the highest possible safety standards at all times. Residual risks might remain.

Enforcement of the rules by UIM or other race officials and in particular but not limited to the technical scrutineering does not guarantee the safety of racing or the safety of the scrutineered boat.

Scrutineering is not intended as a construction/ condition survey.

The racing license issued by the National Authority or a super license issued by the UIM does not guarantee that a driver is physically able to race safely nor that he has sufficient experience or education.

Teams and drivers are solely responsible for their own safety including but not limited to their physical and educational ability to race in the relevant class, the safety of their boats and other gear and the safety of their racing activity. This responsibility includes racing with prudence and taking technical measures which are not mandatory in the rules but deemed necessary.

UIM shall not be liable for any damage, injury or death due to inadequate rules, breach of existing rules by participants or failure to enforce rules by the race officials.

## **208 – HAND SIGNALS**

The following hand signals are to be used by drivers and/or crew members at an accident scene to advise rescue personnel of their requirements.

### **HANDS CLASPED OVER HEAD**

OK - No help needed at this time

### **THUMBS - UP**

OK

### **BOTH HANDS WAVED OVER HEAD**

Need immediate medical assistance

### **ONE HAND WAVED OVER HEAD**

Need immediate tow or fire extinguishing assistance

### **NO SIGNAL**

Immediate response by nearest personnel

### **ONE HAND RAISED WITH CLENCHED FIST WHILE ON PLANE**

Caution - Debris or accident ahead!

Slowing or avoidance maneuver to follow.

All drivers, before being issued with their annual licence, must be tested on these signals.

## **209 - POSTING OF THE RESULTS**

The results of each race and heat must be posted at the pits in a clearly visible position, specified during the driver's meeting. The results must be printed or typed. The results must include UIM title, class name, race or heat number, race date and venue. In case of restart it must be mentioned with adding after race or heat number letter R and in case of last heat second restart R2. For boats and drivers the results must include position, boat number, first name and surname of driver(s), nationality of driver(s), time (or speed)/laps and points. The nationality of all drivers – either by using a three letter abbreviation for the countries worldwide as listed by the IOC or as full names of the nations in English language. Additional information such as sponsor, boat may be mentioned.

All entered drivers, which were accepted for the race by race secretary and technical scrutineers, must be mentioned in the race final results including these, which not qualified to the final heats with mentioning DNQ.

The official results must be posted on the official notice board within an hour of the end of the races (heats) and at least 30 minutes before next heat or race for the relevant participants.

Results must be signed by the OOD or by a person delegated by the OOD and has to include actual time of posting. Reasons (rule number) of given penalties must be defined.

The following abbreviations are to be used in the results for boats or drivers which did not get a result:

**DNS** – Did Not Start – those boats that did not leave the start position after the start, (start jetty), or did not come to the start position;

**DNF** – Did Not Finished – those boats that did not take the checkered flag;

**DNR** – Did Not Restart - those boats that took part in the original start but did not take part in the restart;

**DSQ** – Disqualified – those boats whose results cancelled;

**ACC** – Accident - those boats which caused a stoppage of the race or heat because of an accident.

**DNQ** – Did Not Qualify – those boats which entered the race but did not qualify to the final races.

## **210 – PRIZES**

### **210.01**

Prize giving cannot take place until at least 1 hour after posting of provisional results and NOT BEFORE the technical post race inspection is finished and a protest time against its results has expired. In S, T (GT) and P series Titled events, the final heat must be completed at least 2 hours before the scheduled time of prize giving to ensure the technical scrutineer has enough time to find the correct winners.

The Race Jury, in the meantime, must not be dismissed.

It is recommended that immediately after the final race, the provisional first three drivers are paraded in front of the spectators, and introduced to the public and to the media on the official podium.

At UIM title event prize giving ceremony it is mandatory that awarded competitors wear their racing suits or team uniforms and decent footwear.

### **210.02**

A National Authority may ask to reduce the number of prizes according to the number of competitors. However, the value of the prizes must be maintained, as provided for in the advance-programme. This possibility must be explained in the advance-programme.

## **211 - REPORTS**

### **211.01**

As soon as the results have been verified, the Race Committee forwards results of the race to the Sports Commission of his National Authority and UIM Secretariat by fax and/or e-mail. If the results are taken into consideration for the granting of a trophy or a prize, the points must be sent to the UIM together with results.

### **211.02**

Within 8 days the Race Committee sends following documentation to the Sport Commission of his National Authority and to the UIM Secretariat:

- 211.02.01** Classification and distribution of prizes;
- 211.02.02** Report of the timekeepers;
- 211.02.03** List of drivers;
- 211.02.04** Penalties;
- 211.02.05** Documents on any records achieved in conformity with the UIM rules;
- 211.02.06** List of protests and decisions relating to these protests;
- 211.02.07** All necessary documents in order to evaluate the meeting or the race.

### **211.03**

Details of technical disqualifications of drivers to be reported to their National Authorities per rule 503.01.2.

## **300 - RULES FOR CIRCUIT RACES**

### **300.01 - DEFINITIONS**

<b>French</b>	<b>English</b>	<b>Italian</b>	<b>German</b>
Course	Race	Gara	Rennen
Manche	Heat	Prove	Lauf
Tour	Lap	Giro	Runde
Circuit	Circuit	Circuito	Rundestrecke
Parcours	Dist. covered	Percorso	Rennstrecke
Base	Base	Base	Messtrecke

### **CIRCUIT**

A circuit is a closed course defined by buoys where races are to be held.

Circuits must be anti-clockwise.

### **DISTANCE COVERED:**

Distance covered is the total distance to be covered per heat or race.

### **BASE:**

A base is a course expressly measured for record attempts.

### **MARKS OF THE COURSE:**

Any objects specially indicated as such in the race instructions, are to be considered as marks of the course.

### **OBSTACLE:**

Any non specified object is considered as being an obstacle to free navigation.

### **RACE:**

A race is a competition in speed between boats held in one or more heats.

### **EVENT:**

An event is one or several races held at the same venue and within one, or more days.

Timed trials, qualification races and final races count as one event.

### **LAPS:**

When calculating percentages of races in any circuit rules: ONLY full completed laps (Rounded up) can be counted.

(eg; 75% when full race is 7 laps = 5.20. Rounded up = 6 laps)

## **301 - TIMING**

In all international races and championships the timing is carried out by officially appointed timekeepers using certified timing devices graduated to one tenth of a second. The devices must have a split second system one part of which must be capable of being stopped and restarted or any electronic of the same or better accuracy. At World and Continental closed course Championships, it is mandatory to use electronic timing and be able to multi-time more than 5 boats at a time.

## **302 - CIRCUIT**

### **302.01**

All circuits must be measured on site by official surveyors or measured on an official chart of not less than 1/25 000.

At all UIM titled races the length of circuits must be:

Classes	Length of Lap	Max Straight Length
GT30, OSY400, F4		
O/F classes from 125 through 350	Max 1500 metres	500 metres
STP Classes up to 550cc		
JT250/GT15, ET-15,EH-15	800 - 1100 metres	400 metres
All other classes	Min 1500 metres	850 metres

Please note the start straight in any class **must not** exceed **500** metres in order to accommodate the "alternative start procedure" (307.02).

The alignment of the start pontoons, or the start line should be such that the pole position has the maximum advantage towards the first turn buoy, compared with the last positions on the starting grid.

If the length of the course cannot be certified, the marks having drifted or for any other reason, the speed is not to be declared in the results (or used in the event of a "dead-heat").

It is recommended that the pits be sited where possible away from the race course on the outside.

### **302.02 - RACE CONTROL**

- Race control should be situated so that the circuit can be easily seen and controlled;
- The race should be observed by three persons:
  - the O.O.D.; or his assistant;
  - one or two Commissioners or one or two members of the Jury;
- The O.O.D.; is the general observer of the race, being in radio or telephone contact with the assistant, the Deputy Officer Of the Day and the rescue team;
- The other two supervisors share the circuit in observation;

## **303 - MARKS OF THE COURSE**

### **303.01 - DEFINITIONS**

The Marks of the Course are any objects (boat, buoy...) that are specifically designated as such in the racing instructions. The objects that are not designated specifically as such are to be considered as obstacles.

The organisers must ensure that the position of the buoys does not present any danger to the drivers.

Course turn buoys must be of a single colour of either orange or yellow 70 x 70 cm (28` x 28`) except the mark on the starting/finishing line buoy which carries a black and white chequered buoy or a white and black striped buoy.

The safety zone (150 m minimum length) is defined by at least one buoy which carries a white and red chequered identification or a white and red striped identification.

The buoys are to be made of rubber or similar material.

Should any mark be removed from its proper position either by accident or otherwise, the Officer of the day shall,

if possible, have it replaced. Should it be impossible to replace the mark in time for the boats to round it, the Officer of the day shall decide whether the race is to be restarted or not, according to the restart rules.

Outer course marker buoys shall be placed on the race course defining the outer limits of the course.

These outside markers shall be visually different (different color) from the inside course markers. The buoys shall mirror the inside markers as practicable, with a suggested minimum of three straightaway outside markers placed at approximately  $\frac{1}{4}$ ,  $\frac{1}{2}$ , and  $\frac{3}{4}$  of the straightaway distance; the special marker for the start finish line may be one of these straightaway markers. Protection buoys may also be placed on the course to designate hazards.

The area beyond the outer course markers is out-of-bounds. Driving outside of the area marked with outer course marker(s), leads to disqualification of the driver from the heat or qualification in question.

### **303.02 - TURNING BUOYS**

Any turning point of the circuit must be marked with a minimum of two buoys.

Recommendation: the two or more buoys should not be tied up together.

All turning buoys must be passed to the right unless otherwise stipulated in the advance program and repeated during the drivers meeting.

On circuits with both left and right hand turns, orange turn buoys must be for left hand turns and yellow buoys must be for right hand turns.

## **304 - SIGNALS FROM THE SHORE**

Start lights must be prominent, well visible and in stable position. A start light test is to be performed before the first start.

### **304.01 - CALL SIGNALS**

When a race, or heat has been started a call signal shall be put up to inform the drivers in the pit area which class is the next to start.

A signal consists of a 35 x 90 cm white board, with the class designation (F500, S850 ...) in black.

The signal should be put in a place where it is easily read from the pit area. If two or more classes start together the call signals for these are to be put up together.

If the time to the next start is so long, that it is not necessary to put the boats into the water immediately, the signal can be supplemented by a sign of similar size and colours showing the estimated starting time.

### **304.02 - FLAG SIGNALS**

The flags used for signalling are the same for all series and must be used in all countries.

The flags used for signalling have the following meaning:

Red: To stop the race and mark serious danger on the circuit (see rule 311.01.2 for red flares);

Yellow: Danger on the circuit. In a yellow flag situation (practice or time trials) the driver must slow down to a safe speed;

Minimum size of red/yellow flags: 1000 mm x 600 mm

Black: The driver to whom the flag is shown must immediately return to the pits where he will receive instructions from a race official. The flag must be accompanied by the race number of the boat to be stopped.

Chequered, white and black: finish;

Green: This is the signal that all boats are ready to go to start procedure

## **305 - THE START**

### **305.01**

Starts are:

- flying start with clock (14 boats maximum and shall not be used for World or Continental Championship events)
- dead engine start.

### **305.02**

After the starting signal has been given, no boats are allowed on the course other than competitors and official service craft.

### **305.03**

Any boat starting late shall not cross the starting line later than 5 minutes after the starting signal has been given in circuit races (heat races).

Any boat starting late is not allowed to start after the first boat which finishes the race has crossed the finishing line.

Any boat starting late is not allowed to start after the delay provided for in the advance-programme in endurance or long distance races.

## **305.04 – QUALIFYING**

### **305.04.01 - COMPULSORY PRACTICE**

Every driver must make a minimum number of full laps and at least one full lap on the race course during the practice session before time trials, qualifications or final heats of the race.

### **305.04.02 TIME TRIAL**

Time trials can be organized in two ways:

- Timed practice, where the timing team takes times of all boats' full laps and the best full lap time is counted as the drivers' time trial result;
- Alternatively, a minimum of 2 timed full laps (total laps = 4) on the water for each boat. Warm up lap, 2 timed laps then safety lap. Only one boat of on the race course during the actual timed laps. The organizer must ensure that all boats have equal conditions for time trial (except change of the weather).

### **305.04.03 - QUALIFICATION HEATS**

If the number of drivers entered is too large for all of them to start together, the Race committee has to split the group of drivers into several groups.

The Race committee will have each group race a selection race followed by a second chance heat. It is mandatory that time trials are run to evaluate boats into the two groups instead of random selection.

Drivers of one same nation must be evenly distributed into separate groups.

Example: based on a circuit that can accommodate 20 boats, with 30 entries.

2 groups of boats;

After the selection heats:

the first 8 in each group are selected = 16 boats

A second chance heat grouping the 14 boats that have not been selected:

the first 4 in this heat are selected = 4 boats

Participants in the final heats: 20 boats

The number of laps in the qualifying heats will be reduced and this number, which will be fixed by the organiser, must be mentioned in the advance-programme and recalled at the drivers briefing.

A minimum of one-hour interval is required between the last qualifying heat and the first final heat.

As an alternative procedure, when the number of entries exceeds the maximum allowed in the water registration an agreed number of drivers will qualify for the final races from their fastest time in the time trials. Those drivers that have not qualified will run a single qualifying race and a certain number of drivers will be qualified from that race.

If necessary, after all the qualifying races, the organisers reserve the right to make up the number of boats in the final races to the maximum permitted from the second chance heat, when any qualified driver indicates that they cannot participate in the final heats. This cannot be done after the penultimate heat.

## **306 - FLYING START WITH CLOCK, DISCS AND GUN**

The clock must have a dial of no less than 2 meters (6ft. 3/4 ins.) and marked out as follows:



This clock is to be driven electrically or mechanically. It has only one hand moving continuously and indicating the seconds.

The official start is given by the clock. The discs and the gun are supplementary to the clock.

The clock must be run for the majority of the training periods.

### **306.01 - PLACE OF THE CLOCK**

The clock must be placed 3 or 4 metres before the starting line and less than 5 metres above the water level.

### **306.02 - DISCS**

A set of five discs, each having a minimum diameter of 40 cm (15 3/4 ins.) pivots in a white frame. One side of the disc is black and the other white. The discs are numbered 5, 4, 3, 2, 1 on the white side. The figures must be 25 cm high at least and 5 cm thick. These discs are worked by hand. It is recommended, to use discs as large as possible.

Discs must be located in a place which is clearly visible to all the drivers. Sometimes, it is necessary to have two sets of discs (one close to starting line and the other easily visible from the boat park).

### **306.03 - GUN**

Any audible signal loud enough to be heard above the sound of the motors. The gun may be replaced by a rocket pistol.

No other signal than those described above are to be used.



### 306.04 - STARTING LINE

The starting and finishing line is marked by two poles erected on the shore and surmounted by a triangular mark with one top upwards and one top downwards.

Both poles are erected on the shore at different heights placed in line one behind the other adjacent to the jury.

The distance between the starting line and the first turning buoy must be at least 300 metres (984 feet).

The distance between the shore and the inside safety buoys before the starting line must be at least 50 metres (164 feet).

### 306.05 - SAFETY ZONE

It is compulsory to determine a zone of 150 metres minimum in length marked by one or two buoys with a red and white chequered or striped identification at one end, the other end is the starting line marked by one or by two buoys with a black and white chequered or striped identification.

### 306.06 - BEFORE THE START

During the five minutes preceding the start, boats must not enter in this safety zone, except for the start.

When the warning signal is given 5 minutes before the start, no boats are allowed to be on the water except racing boats and official boats.

The rules of the road (Rule 312) are also applied in that zone. Any infringement will lead to the disqualification for that particular heat or race.

The organisers using this starting system must use a still or movie-camera or a video tape recorder which must be synchronised with the clock.

### 306.07 - THE START

The start will be given as follows:

- a) 5 minutes before the start, the class letter is hoisted and a gun fired. The five discs are shown with the numbered side towards the course. The hand of the clock is placed on the zero position (12 o'clock).
- b) 4 minutes before the start, the disc number 5 is turned black.
- c) 3 minutes before the start, the disc number 4 is turned black
- d) 2 minutes before the start, the disc number 3 is turned black
- e) 1 minute before the start, the disc number 2 is turned black, the clock is started
- f) At starting time, the disc number 1 is turned black. The clock is stopped and a gun is fired.

The clock, discs, letters and gun and camera / video must be synchronised.

### 306.08 - APPROACHES TO THE STARTING LINE

Any boat approaching the starting line other than at a right angle within a zone of 150 metres minimum (495 feet) marked by at least one buoy with a red and white chequered or striped identification (which must be left to port), will be disqualified. Boats cannot enter in this zone during the five minutes preceding the start, boats must not navigate in the reverse direction of the course and rules of the road apply.

A boat which has not left after the starting signal, cannot pass in reverse direction between the starting line.

A mandatory training period will be held to allow drivers an opportunity to familiarise themselves with the safety zone and approach to the starting line prior to actual competition.

### **306.09 - BOAT STARTING BEFORE TIME**

Boats starting before time are disqualified for that race, heat or series.

Boats which cross the starting line in either direction during the five minutes before the start are disqualified and get zero points in that heat.

If the numbers of boats which started before time are all known the race continues and is valid but the boats which started before time are disqualified for that race (or heat).

If the Race Committee cannot note all the numbers of the boat which started before time, it will restart the race. The leading boat across the starting line that starts before time will be disqualified and not allowed to participate in the restart of that race.

## **307 - DEAD ENGINE START FROM A QUAY, A JETTY OR A BEACH**

### **307.01**

All start jetties of the relevant classes should be inclined up to 50 degrees to the line of travel at the start.

Whilst every effort must be made by the organisers to obtain this, a jetty start can still be used even if perpendicular.

Boats should be drawn up stern first, engine dead, to a jetty, floating stage or beach. Boats without electric starts may have external aid from the jetty. Boats with electric starters may not be lifted or pushed by crew during the start procedure.

The jetty or floating stage must be long enough to accommodate all boats starting plus a length equal of 0.75 metres minimum between boats with a minimum width of 2.5 metres.

If the jetty can accommodate all the starting boats with a larger gap of 0.75 metres then the Start official must move these boats to increase this gap.

For the F-Classes, there must be a minimum of 1 meter spacing between boats on the jetty for the start.

The jetty must be stable even when the maximum permitted boats plus maximum 3 mechanics per boat prior to launch. If not the numbers starting must be reduced and must be reported to the UIM by the Commissioner.

Positions on the jetty for the first final heat are determined by times from the time trials. .

Pole position boat does not have the choice of ends. Jetty positions for qualifying heats should be taken from times of the time trials and not random choice.

The qualifying boats from the second chance heat to the first heat for points are positioned at the lower end of the jetty.

Jetty positions, in multi-heat races, after the first heat, are the finishing positions in the prior heat.

### **307.02**

The distance between the start line and the first turn mark must be in a straight line and at least 300 meters.

There must be adequate width, in a straight line, to accommodate all starting boats running in their respective start/jetty lanes from the jetty to the first turn mark.

At dead engine starts, drivers must keep their relative starting lanes to the first turning buoy and through completion of the first turn, not interfering in the path of competing boats. Sufficient room on the inside must be left by the leading boat, if not pole, to allow others higher on the jetty to negotiate the turn.

Breaking this rule will result in one or more of the following penalties, which are disqualification, one lap penalty or a yellow card, depending on the severity.

Drone video coverage for the officials of the starting procedure and the run to the first turn buoy by the boat is encouraged to support enforcement of the lane rules.

### 307.02.01 - ALTERNATIVE START PROCEDURE

There must be a **maximum of 500 meters** distance from the jetty to the first **full** turn buoy. Then the following alternative start procedure can be used.

The placing of a starting/alignment buoy at a **maximum** distance of approximately **250** meters from the jetty, **creating a shallow turn**, may count as the first turn when keeping your lane relative jetty position (rule 307.02). The first actual **full** turning buoy must be placed **a maximum of 250 meters further**.

### 307.03

The start will be given as follows:

When the jetty marshal is satisfied that all drivers are ready to start, with engines stopped he will raise a green flag. (or alternative indication. "whistle" etc.)

The O.O.D. or starter will commence the start procedure.

The O.O.D. or starter may decide at any time, if he judges it necessary, to cancel the start by showing a red flag and could recommence the starting procedure again.

The two minute board is shown. Alternatively the time can be lengthened to 3 minutes if notified at a drivers meeting.

One minute before red light is switched on a "1" minute board is shown.

30 seconds before red light is switched on a "30" board is shown.

Engines must not be run after this signal.

At the end of the 30 seconds the red light is switch on.

Not before a minimum of 5 seconds are the Red lights switched off.

The starter has the choice of between 5 seconds and up to a maximum time of 12 seconds to switch off.

This is the START signal.

All information start minute boards must be shown for their total applicable time.

### 307.04

Those drivers running their engines during the last 30 seconds before the start are disqualified.

Those drivers leaving a jetty, a quay or a beach on the power of their own boat engine are as started drivers.

Those drivers leaving a jetty, a quay or a beach on the power of their own boat engine between 2 (3) minutes board and 30 seconds board being shown, are disqualified.

Pushing (to gain an advantage) and/or lifting boats with electric starter leads to one lap penalty.

Jump start - Those drivers starting or cranking their engines or leaving the jetty whilst the red light is on lose one lap.

Those drivers rotating their engines (with ignition switched off) prior to the red lights going off lose one lap.

After an announced time the red light will be shown again.

Late starters: A driver who has failed to start before the red light is shown again, must wait until the whole field has passed the start jetty and the jetty marshal indicates that he may join the race in the proper way.

Any boat starting unsuccessfully must be returned to shore. Any crew member swimming, or wading, out to a boat will cause his entry to be disqualified.

### 307.05 - MATCH RACE RULES

Qualifying from time trial position. (numbers on sheet are timed trial qualifying positions).

#### Qualifying matrix for 16 boats

- First elimination round

- Quarter-finals
- Semi-finals
- Third place race
- Final

#### **Qualifying matrix for 8 boats**

- First elimination round
- Semi-finals
- Third place race
- Final

#### **Course**

- Three pin course (by a straight line)
- Round the first turning buoy it should be a sausage buoy (safety zone) to keep the lane for both drivers
- The third buoy is the same for both drivers
- Finish line is the same for both drivers
- Both drivers do one long and one short lap
- The longest lap should not be more than 800 m total

#### **Start**

- By light
- From a pontoon
- Side by side
- Inside driver go for the shortest lap
- The outside driver goes for the furthest buoy
- With double heat the driver switch lanes
- If a driver does not start the other driver must complete the course

#### **Finish single heat**

- The driver who passing the finish line first is the winner of this Match Race heat, there may be time keeping, if required for minor places overall position.

#### **Finish double heat**

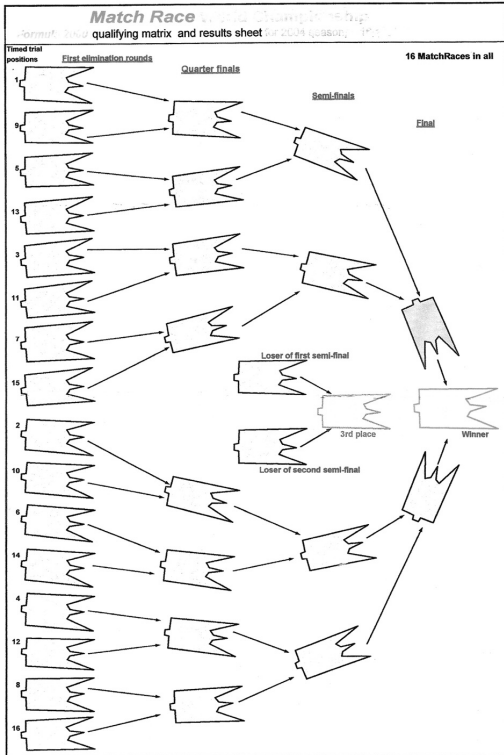
- The driver who made the best average time is the winner of the double heat

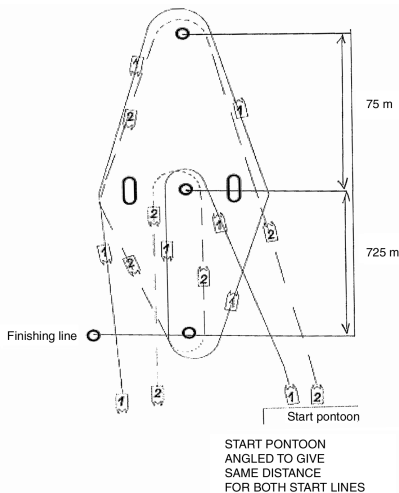
#### **Penalties (disqualification)**

- Non-start
- Jump start
- Cutting course
- Impeding other course

#### **Protests**

Protests must be entered verbally by radiomen or the team manager on behalf of the driver before the next round is started. Protests to be solved by UIM Commissioner before the next round is started. Protest fee 80 euro to be paid not later than one hour after the end of match race. No rights of appeal in match race.





### **308 - RACE CANCELLED**

The Race Committee has the power to cancel any race should unfavourable weather or other serious circumstances render such action necessary.

### **309 - RACE POSTPONED**

#### **309.01**

The Race Committee has the right to postpone a race, in which case the letter "R" and the class letter are hoisted. Races this postponed are subject to written notice on the notice board.

The Officer of the day may postpone the start, even after the first signals have been given, but only in cases of force majeure or if an error in the starting signals has been made.

#### **309.02**

In both cases, signalling is to be recommenced. When the need for postponement has passed, the Race Committee signals the start according to the instructions contained in the programme.

New entries are not to be accepted for postponed races.

Only drivers who duly entered and were present on the jetty when the race was postponed are admitted.

#### **309.03**

A race, heat or leg must in no case be postponed more than 24 hours. If it is impossible to race within this time, the other races, heats or legs held will be used as a basis for classification.

## **310 - RACE SHORTENED**

A shortened race is a race over a course or a leg which has been shortened by the Race Committee before the start.

If a race is shortened due to force majeure, it is at the discretion of the O.O.D. (and the UIM Commissioner if present) to alter the time table, and if necessary the course layout accordingly.

If the race is declared to be on rough water, the number of laps should ideally be maintained, but may be reduced if seen fit by the O.O.D. If time permits, the circuit layout can be changed, as agreed by the O.O.D., UIM commissioner and the driver's representative.

If there is a change to the race course after time trials, there may be extra fee practise, if time permits.

The decision with instructions about the shortened course must be handed in writing to the drivers and the timekeepers.

## **311 - RACE STOPPED AND RE-STARTS**

### **311.01 - GENERALLY**

1. A stopped race is a race interrupted by the O.O.D. after the start.
2. The stopping of a race is the sole decision of the O.O.D. and officials specially mandated by the O.O.D. The signal to stop will be the display of red flags shown at prominent positions together with mandatory firing of a red flare or buoyant orange/red smoke flares (if local rules allow). Not using flares or smoke must be mentioned at drivers briefing. The display of these flares is optional at UIM non- titled events. It is recommended that the start lights are turned toward the general direction of racing after the start and switched on, in a red flag situation as an additional warning.
3. A race is also stopped when anybody is in the water on the course or is considered to be injured, and/or continuation of the race constitutes a danger to those involved.
4. Drivers whose actions result in a stoppage shall not be scored or restart. If the sanctioned driver protests, he shall be permitted to restart, the result being subject to the decision of the jury. So that the racing is not delayed, and protest about the inclusion of a driver after stoppage may, at first, be verbal. A normal written protest must be submitted after the end of the heat or race. ***If no written protest is submitted after the end of heat or race, the pilot who gave verbal protest will be disqualified from the whole event.***
5. Any penalty incurred in any heat is carried forward to any restart of that heat or race.
6. Disqualified drivers shall not restart (unless under protest see 4).
7. Jetty positions are the race positions at the end of the lap prior to the stoppage ***or in case no laps were scored, jetty positions from previous start.***
8. Drivers who do not succeed in reaching the jetty with the power of their own engines shall not restart. This rule applies only for classes with electric start.
9. Repairs may only be carried out on boats that have returned to jetty (Rule 8). Repaired boats may rejoin the race as directed by the jetty marshal. Further definition of the repair areas will be given at drivers briefing.
10. In the event of a restart any repaired boat must be ready to take up its correct position on the jetty as directed by the jetty marshal. If the boat is not ready it must start from the bottom end of the jetty. If the race has already restarted the driver can only start under the directions of the jetty marshal.

### **311.02 - RACING IN HEATS**

1. When the leading boat has completed less than 70 % of the required laps the race shall be restarted.
2. There shall be only one restart. In a final heat there shall be a second restart if the first restarted final heat is stopped before 35% of the required laps have been completed.
3. Laps gained in previous starts are discarded.
4. The restart shall be for the original number of laps and re-fuelling is permitted. Place for re-fuelling shall be indicated by the organiser.

5. When a race is stopped after the leading boat has completed at least 70 % of the required laps there is no restart and full points are awarded.
6. Points for a restarted race which is also stopped are:  
 up to 35 % of the required laps: 50 % POINTS  
 over 35 % of the required laps: FULL POINTS  
 Up to 35% means: 'After lead boat has completed at least one full lap and can all be identified by timing control. Failure means zero points.  
 Points for a second restarted final heat are full points **after lead boat has completed at least one full lap crossing first time finish line and can all be identified by timing control. Failure means zero points.**

### 311.03 - SINGLE HEAT RACING

1. Eligible drivers may rejoin restarts even if not in previous starts.
2. The race shall be restarted when after having deducted one lap for each stoppage the remaining laps are at least 20 % of the original total.
3. Eligible drivers must return directly to the start, no outside assistance, no refuelling.
4. The number of laps to be scored are those at the end of the lap prior to stoppages.
5. Laps scored from the original start and all restarts shall be aggregated for final positions.

## 312 - RULES OF THE ROAD

### 312.01

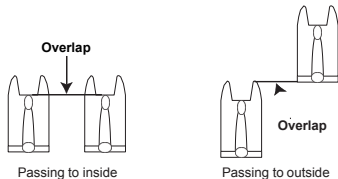
All racing boats must take any action to avoid a collision at all times.

### 312.02 - OVERLAP

An overlap may only be established when two boats are approximately on the same course and the cockpit of the overtaking boat, if passing on the inside is level with the cockpit of the overtaken boat.

When overtaking from the outside, an overlap is established when the overtaking boat has passed the overtaken boat sufficiently to alter course without contact.

When trying to overtake a boat on the inside the driver must anticipate the possible direction of the boat it is trying to overtake and must take all necessary action to avoid a collision (see drawing).





**312.03**

The leading boat has right of way until an overlap is established.

**312.04**

A safe overlap and overtaking manoeuvre is the responsibility of the overtaking boat.

**312.05**

After an overlap manoeuvre, the overtaken boat must give the overtaking boat room to negotiate turn buoys.

**312.06**

The overtaking boat cannot force an overlap situation once the lead boat has started his turning manoeuvre.

**312.07**

An overlap can be attempted from either side of the leading boat.

**312.08 - OVERTAKING**

An overtaking boat shall keep clear of the boat which is being overtaken.

**312.09 - EMERGENCY INTERRUPTION**

For races with a single final race of a length that would utilize restarts that continue (count.) from the laps completed, the OOD may interrupt the race for any reasons of safety or emergency services access, and in which case the rescue boats and race control will show yellow flags. At this signal all drivers must immediately slow down and not overtake.

**312.10 - DRIVING IN WRONG DIRECTION**

*During the race boats must not navigate in the reverse direction of the course. Breaking this rule will result in one or more of the following actions, which are disqualification, one lap penalty, yellow card or no penalty, depending on the severity.*

**312.11 - PASSING MARKS**

When trying to overtake a boat on the inside, the driver must anticipate the possible direction of the boat he is trying to overtake and must take all necessary action to avoid a collision.

When passing a turn buoy and an overlap has been established, both boats must maintain a safe distance from each other and from the turn buoy.

Overlapping while overtaking does not give priority to the boat overtaking on the inside.

**312.12 - ALTERING COURSE**

When one of the boats is obliged to keep clear, the other shall not alter her course, to avoid risk of fouling. A boat must not bear out of her course so as to hinder another in passing to the right.

**312.13 - LAPPED DRIVER**

Drivers who are being lapped should clearly provide free tracks for overtaking drivers. This is done by holding firmly to the right. Even at the right turn with a yellow buoy, the overtaken driver keep to the right, as close to the

yellow buoy as possible and with as straight track as possible.

Drivers who violate the rule can be disqualified. This can be accompanied by a yellow card if the behaviour is dangerous or unsportsmanlike.

## **313 - ROUNDING AND FOULING MARKS**

### **313.01**

A boat which rounds a mark in the wrong way loses a lap. For safety reasons, a boat is not allowed to round the mark again after rounding it the wrong way. A boat which rounds a mark again is disqualified.

A boat is considered as having rounded a mark in the wrong way when the buoy official considers that it has passed the mark on the wrong side after starting to negotiate the turn.

### **313.02**

In the following text first and second buoys refers to the sequence in which they are damaged or destroyed by a boat, not to their position in the turn and the order in which they are to be passed.

In this case, if a driver:

- touches the first turn buoy in a turn: no penalty
- damages or destroys the first buoy: one lap penalty and a fine that will be decided by the Organising Committee and announced in the advance regulations
- touches the second buoy: no penalty
- damages, destroys or dislodges the second buoy: disqualification and a fine that will be decided by the Organising Committee and announced in the advance regulations.

The penalty lap will be deducted at the end of the heat.

Cost of destroying a buoy is maximum 200 euro.

## **314 - FOULING COMPETING BOATS**

If a boat, in consequence of its neglect of any of these rules (312, 313) fouls another boat, or compels others to foul each other, that boat is disqualified.

## **315 - MEANS OF PROPULSION**

All methods of propulsion other than motor and paddle are prohibited.

The action of the wind and current will not entail the disqualification on the competitor.

## **316 - FINISHING A RACE**

### **316.01 - THE FINISH**

The finish is shown to a driver by waving a black and white chequered flag.

### 316.02

A driver who finishes a race or heat must withdraw from the course without hindering the boats that are still in the race.

Drivers have to fulfil at least one extra lap after crossing the finishing line, unless the organiser specifies something else.

A driver who has finished that race and cuts across the course will be disqualified in that race or heat and get zero points.

A boat is timed as completing a race when her bow crosses the finishing line. After finishing the race, the driver must continue to observe any special regulations prescribed by the Race Committee as to keeping clear of the finishing line and the course.

### 316.03

The Race Committee has the right to stipulate the maximum duration of each race.

Races for the international classes are limited to 4 consecutive days.

For races on the sea, an interval of consecutive 24 hrs might be conceded, if the water conditions justify it.

## **317 - SCORING SYSTEM**

### 317.01

The boat placed first will be the one having covered the scheduled distance in the shortest time.

All boats will be classified by taking into account the number of complete laps that they have covered and for those, which have completed the same number of laps, after deducting penalties, the order in which they cross the finish line.

The classification of the race will be drawn up by adding up each driver's points in every final heat [Scale: as listed above: 400/300/225etc to 20th place with 1 point.]

The following scoring system is to be adopted for all races that include "Multi-Heat" Events.

1 - 400 pts	11 - 22 pts
2 - 300 pts	12 - 17 pts
3 - 225 pts	13 - 13 pts
4 - 169 pts	14 - 9 pts
5 - 127 pts	15 - 7 pts
6 - 95 pts	16 - 5 pts
7 - 71 pts	17 - 4 pts
8 - 53 pts	18 - 3 pts
9 - 40 pts	19 - 2 pts
10 - 30 pts	20 - 1 pt

The following points scoring system is applicable for Series races.

The classification of the race will be drawn-up by adding up each driver's points in every final heat.

In order to obtain a general classification of the Championship, the first drivers classified in races taken into account in a Championship will be given points as follows:

1 - 20pts	6 - 10pts	11 - 5pts
2 - 17pts	7 - 9pts.	12 - 4pts
3 - 15pts	8 - 8pts	13 - 3pts
4 - 13pts	9 - 7pts	14 - 2pts
5 - 11pts	10 - 6pts	15 - 1pt

The winner of the Championship will be the driver who will have accumulated the highest number of points. In case of a tie, the number of first positions, second positions etc will be successively taken into consideration. In case of a new tie, all UIM points collected in all the relevant races will be added up (400/300 scale).

### 317.02

To be awarded points a driver shall have completed at least 75 % of the race winner's distance and cross the finishing line after the leading boat has taken the chequered flag.

Only full completed and recorded laps are taken into account when calculating % (rounded up):

[e.g. Heat of 7 laps. 75% = 5.25 laps. So round up to 6 laps].

For drivers with the same total of laps, after deducting any penalties, their finishing order shall be determined by their positions at the finish of the race.

#### For single heat races

Boats that complete 90%, or more of the race distance, but do not cross the finishing line after the winner has crossed the finishing line, will be classified after those boats that have done the same number of laps and also cross the finishing line after the winner.

For a race stopped, the finishing order is that existing at the end of the lap prior to the stoppage.

Organisers may limit the race to a given time after the winning boat has finished, this must be mentioned in the advance programme.

### 317.03

The official results must be posted on the official notice board within an hour of the end of the races.

### 317.04

A general classification of different classes racing together is not permitted.

### 317.05

National classes may be raced at international meetings.

In case of delays in time schedules, international classes have full priority over national classes in rescheduling.

### 317.06

If boats of different series or classes start together every boat must be classified within its own class.

When the programme for a race meeting does not provide races for all classes, boats not provided for may race in the next higher class in the programme, subject to their acceptance by the Race Committee.

### 317.07

It is forbidden to take part in a race for a lower class than that to which a boat belongs except with the written consent of all competitors.

The Race Committee may hold a race, as a separate class, for one-design hulls equipped with identical motors.

### 317.08

If post-race inspection reveals that a boat or motor is illegal, that entry shall be disqualified for each heat in which it raced, and the order of finish shall be corrected for each heat. Final overall race positions shall be obtained by adding the points from the heats after the order of finish has been corrected for each heat.

## **318 - DEAD-HEAT**

### **318.01**

Two boats are in a "dead heat" when :

- They cross the line together,
- They obtain the same points in a multi-heat race.

### **318.02**

In case of a dead heat, the boat having the faster race time, in any heat, will be declared the winner.

Only full completed heats can be used for this purpose.

If the course has been changed considerably between heats, the race time cannot be used.

But if the two relevant race boats race in at least two heats on the same race course (old or new) the faster race time can be applied.

Failing this then revert back to the first full heat and the fastest boat (whatever position) will decide the outcome of a dead heat.

### **318.03**

If the above has been applied, and there is still a "dead heat", the boat having a higher average speed on any lap in any heat, will be declared the winner.

## **400 - JURISDICTION**

### **401.01 - DEFINITIONS**

Jurisdiction applies to:

The UIM Offshore, Circuit, Aquabike and Pleasure Navigation Rules.

### **401.02**

No claim for damages arising from an infringement of any of the UIM rules or the advance notice or any of the race instructions or race bulletins shall be adjudicated upon by any race committee or appeal authority, but shall be subject to the jurisdiction of the courts.

The crew of a racing powerboat which acknowledges infringing a rule does not thereby admit liability for damages.

The findings of fact, and the decision of the race judicial bodies shall be relevant only to the purposes of the powerboat racing rules and shall not be referred to in any proceedings for damage without the written consent of all parties to the protest.

## **402 - JUDICIAL BODIES**

### **402.01 - THE INTERNATIONAL JURY**

The Jury hears any protest raised by a driver only.

#### **1. COMPOSITION**

The Jury must be composed of at least three members, including the Chairman. The Organisers of the event appoint the Chairman. Each competing country, including the hosting country, may appoint one member delegate who can represent only one country. These appointments must be made in writing, authorised and signed by a National Authority Official and delivered to the event Secretary.

If there are not enough NA appointed members to form a Jury of three persons, the Organisers must appoint additional members, but only enough to reach three persons.

The Jury composition will be announced at the first drivers meeting. The jury must be present at the first drivers meeting.

Race Officials or participating drivers cannot be Jury members. The appointed UIM Commissioner(s) to the event is (are) full member(s) of the Jury with only one vote.

No member of a jury may bring any additional person, e.g. as his translator, to the jury meeting.

In an event comprising races of several classes, it is possible to keep any authorized jury member to adjudicate on any matter of the jury, irrespective of the class he/she happens to represent.

#### **2. AUTHORITY AND DUTIES**

The Jury sits as long as the event lasts, and hears all protests relating to that event.

The jury must decide as soon as possible on all protests presented to it during the event.

### **402.02 - INTERESTED PARTIES**

No member of a Jury who has taken part as a competitor or Official in the race concerning which a judgement is to be given, or knows himself to have directly or indirectly an interest in one of the parties involved, may judge the protest.

However, a member of an International Jury shall not be disqualified even if one of the parties is from his NA.

## **403 - PROTEST PROCEDURES**

### **403.01 - VALIDITY OF PROTESTS**

Only a driver may protest against facts pertaining only to the races in which he takes part.

Joint protests signed by several drivers will not be considered.

All protests must be in writing - type written or hand written in printed characters in English.

It must state the reason for the protest and be accompanied by any relevant documents that shall provide evidence within the given time and any protest fee as stipulated by the Race Organiser.

All protests must be signed by the protester.

The protest must be handed to the Race Secretariat who must, in the presence of the protester, record the time of receipt.

Any costs involved in verification are to be borne by the losing party.

A written protest can be withdrawn by the protester; he then loses the protest fee.

#### **403.02 - PROTEST FEE**

The amount of the Protest fee must be decided by the National Authorities and it must be published in the advance programme. The maximum amount for a Protest fee will be decided by the UIM General Assembly. It will be 80 E, or an equivalent sum in the national currency.

#### **403.03 - RIGHT OF PROTEST**

A protest can be lodged against the posted provisional results or against any decision made by the Race Committee or against one or several competitors.

In the event of a competitor protesting against a penalty imposed on him by the O.O.D. or the UIM Commissioner and another driver protesting simultaneously against this competitor due to the same incident, the jury will have only one meeting with both competitors being party of this protest procedure.

A protest can only be lodged on a subject which directly concerns the protester himself. A protest which complies with these rules cannot be refused by the Jury.

No protest is permitted on jury decisions, they may only be contested by appeal.

#### **403.04 - TIME OF LODGING A PROTEST/ PROTEST PERIOD**

A protest regarding the qualification of a boat, a motor, or a driver must be made before the first drivers briefing. Starting in a race is considered as acceptance of the conditions and the eligibility of the other competitors. The only exception to the above is when the protester can prove the facts were not given to him before the drivers briefing, then a protest can be lodged up to one hour after the posting of the results.

Any other protest must be lodged within one hour of the first results being posted with the following exceptions:

A protest of a driver (driver "A") against another driver (driver "B") can be lodged within 30 minutes after the posting of the protest form according to rule 404.03 if driver "B" has been penalized and himself protested against this penalty. Without lodging such a protest driver "A" shall not be entitled to appeal against the jury decision.

A protest against any other decision, posted after the posting of the first results can be lodged within one hour after the posting of this decision.

#### **403.05 - JUDGEMENT**

Decisions by the Jury shall be reached by simple majority of votes. In the case of equal votes, the Chairman's vote will be the casting vote.

In the event of a protest, penalties may be agreed, rejected or changed by the jury. If a protest is upheld by the Jury, the fee must be returned to the protester.

Any Judgement pronounced by the Jury stays in effect until altered by the UIM International Court of Appeal.

#### **403.06 - NOTIFICATION OF DECISION**

All decisions by any jury, the minutes of the meeting and the justification of the decision must be notified to the concerned parties in writing, including their right of appeal.

#### **403.07 - AVAILABILITY OF DOCUMENTS**

All documents relevant to any decision by the Jury must be filed with the organising N.A. and held available for a higher authority until the time limit for an appeal has expired.

### **404 - HEARING OF THE PROTEST**

#### **404.01 - RIGHT TO A HEARING**

Any person being party to a protest, or being charged for an offence against the rules shall have the right to be heard before the Jury in order to defend himself.

#### **404.02 - EVIDENCE**

It is the responsibility of the parties involved in a protest to ensure that witnesses appearing on their behalf together with any other evidence are present and the Chairman of the Race Jury at his/her sole discretion may take their availability into account when determining the time of the hearing.

Any costs incurred by the appearance of witnesses shall be borne by the respective parties unless decided otherwise by the Jury.

#### **404.03 - THE HEARING PROCEDURE**

The following procedure must be followed in all hearings unless otherwise stated elsewhere in these rules:

- A copy of the protest must be posted in the same way as the results. The time of posting must be noted on this copy.
- Together with a copy of the protest, the Jury must give written notice to all parties of where and when the hearing will take place. Reasonable time shall be allowed to the parties for the preparation to the hearing.
- If any party duly notified, fails to appear without giving an acceptable reason, judgement can be rendered by default i.e. the missing party shall lose the protest.
- Written minutes must be taken.
- All parties to the case are entitled to be present and to hear and question all evidence at the hearing up to the time the Jury makes its decision.
- If the jury meeting involves a junior (less than 18 years of age) then he/she must be accompanied throughout the meeting by an adult (parent)/guardian).
- The protest shall be read out to the parties.
- A party to the hearing who believes that a member of the Jury is an "interested party" or otherwise not suitable to decide upon the protest shall object at the beginning of the hearing and before he/her states his/her own case. Failing to do so will result in acceptance of the relevant jury member unless the party can prove that the circumstances and facts resulting in the ineligibility of the jury member came to his/her knowledge only after this moment. In this case the party has to object immediately after having obtained the relevant information.
- Then the Jury shall decide, whether all formal requirements of the protest are fulfilled (403.01 – 403.04 and possible additional rules of the relevant class). Failures shall lead to the protest being void. The parties shall be given the opportunity to give statements if failures are found and before a final decision on the formal legality of the protest is taken



- The parties shall be invited to state their cases. The parties may call witnesses. Each witness, after having given his account of the case, may be questioned by all parties and by the members of the Jury.
- Any member of the Jury who is familiar with the case may give his evidence
- The parties shall be entitled to question each other and any member of the Jury who may have given evidence.
- The witnesses shall withdraw and the parties shall be invited to make a final statement of their cases.
- The Jury may recall any party, previous witness or new witness and call on other evidence to verify the facts.
- The parties must be present during the whole of the recall and must be given the opportunity to question any new evidence after which they may re-make their final statements.
- After all evidence has been assessed the situation with the protest may be discussed. The hearing will then be closed and the Jury shall debate the case and take a decision in a closed meeting and no other person but the jury members have a right to be present.
- For further procedure see rules 403.05-403.07.

## **405 - THE APPEALS PROCEDURE**

Unless stipulated differently below, the rules for the protest procedure shall apply to the appeals procedure as well. With reference to the 405 appeals procedures, any time limits which end on a Saturday or Sunday shall end on the following Monday. If the Appellant misses any time limit the appeal will be rejected as void.

The UIM will decide on Appeals arising from International titled events according to the "UIM International Court of Appeal" rules unless differently laid out in these 405 rules.

The UIM will not decide on Appeals arising at UIM IOR. Such appeals will be handled by the organizing National Authority according to applicable national rules for Appeals.

### **405.01 - UIM INTERNATIONAL COURT OF APPEAL (ICA)**

The ICA sits whenever the Chairman calls a meeting.

### **405.02 - INTERESTED PARTIES**

No interested party shall be member of the ICA as set forth in the ICA rules.

### **405.03 - RIGHT OF APPEAL**

A decision by a Jury may be appealed by the parties involved in the Jury meeting when they consider that an injustice has been made against them and/or fresh evidence has been made available that may alter the decision of the Jury.

A driver can also appeal a penalty, imposed against him without the prior lodging of a protest, but only if this was not possible, because the race Jury has been dismissed before or within the protest period.

### **405.04 - NOTICE OF INTENTION TO APPEAL**

The intention to appeal must be notified in writing to the Secretariat of the UIM by the interested party within four days of the day following the Jury decision or in the case of a decision against which a driver can appeal without the prior lodging of a protest within four days of the day following the notification of this decision to the NA of the driver or if earlier to the driver concerned.

#### **405.05 - TIME LIMIT**

All appeal documents and fees must be received within ten days from the date when the notice to appeal was received by the UIM Secretariat.

#### **405.06 - LODGING OF AN APPEAL**

The appeal must be sent by telefax, letter or E-mail and it must be signed by the appellant. The reasons for the appeal must be stated.

Address, telephone, e-mail and/or fax should be clearly mentioned on the appeal, so that the UIM can send any correspondence directly to the driver with copy to relevant N.A.

#### **405.07 - NOTIFICATION OF THE PARTIES OF THE APPEAL**

The UIM Secretariat must within two days from receiving the appeal, notify by telefax or letter the other parties that an appeal has been lodged and that they may send a rejoinder.

Such rejoinders must be received within ten days from receiving this notification.

#### **405.08 - TIME LIMIT FOR DECISIONS ON APPEALS**

All appeals must be determined no later than forty-five days after the date when the appeal documents and fees were received by the UIM Secretariat.

#### **405.09 - UIM INTERNATIONAL COURT OF APPEAL (ICA) DECISIONS**

The ICA takes its own decision based on every information available. The decision of the jury may be upheld, changed or not upheld. The decision of the ICA is final.

#### **405.10 – COSTS**

For titled international championship series or for events which require a UIM Superlicence, the appeal fee is 2000€. In addition the driver has to pay 3000 € to the UIM for possible costs of the ICA (meetings, telephone, fax, laboratory, experts or other costs of the appeal procedure).

The appeal fee for single event UIM Championships is 1000 €, in addition the driver has to pay 1000 €, to the UIM for possible costs of the ICA.

If during the procedure further costs arise, the Appellant has to deposit the missing amount accordingly within 14 days from notification.

The driver who appeals has to pay for the meeting costs anyway if the appeal is upheld or not. If the costs of the appeal committee is less than 3000 € then the difference will be paid back to the driver. The appeal fee of 2000 € will be refunded if the appeal is upheld.

If the original decision is changed by the ICA (405.09), it can decide to refund a percentage of the appeal fee if appropriate.

If there is an infringement of rules 405.04 or 405.05, the Chairman of the ICA can decide that the appeal is not considered valid since the deadlines were not respected. In this case 50 % of the received appeal fee will be reimbursed to the appellant.

Further appeal fees or deposits as foreseen in the ICA rules do not apply.

The driver may agree to forego an Appeal Committee meeting and for the appeal to be handled through telecommunication channels, if possible, in order to minimise the cost of the appeal.

## **406 - PENALTIES**

### **406.01 – GENERAL**

Any proven breach of applicable Rules may be penalised.

If the rules do not determine a special penalty for the relevant breach, the penalty to be given has to be proportional to the seriousness of the breach. The proportionality is at the discretion of the decision maker.

The UIM Executive Committee or the relevant National Authority shall only impose penalties, when they deem the relevant infringement to be so serious, that it has to be penalized although the deadlines for penalizing or lodging a protest have already expired. After the expiry of the aforementioned deadlines, a penalty for an ordinary breach of the rules shall in general not be imposed.

The Race Jury or the ICA following a protest or an appeal can (only) impose penalties, which can be imposed by the O.O.D.

### **406.02 - DEADLINES FOR PENALIZING**

The first posted results are provisional for one hour.

The National Authority and/or the UIM Executive Committee can only impose penalties within 3 month from the day, the infringement occurred.

These deadlines are not valid for penalties imposed by the O.O.D. for the reason of post race technical scrutinizing and under the condition that this is stated on the results sheet.

In this case, the results will remain provisional until one hour after the finalization of the post race scrutineering.

The date and time of finalization of the post race scrutineering must be recorded by the UIM Technical Commissioner or other technical scrutinizer in charge.

If the post race scrutineering cannot be finalized until the end of the event and the O.O.D. has already left the race site, the penalty has to be imposed as soon as possible after the receipt of the scrutineering results.

### **406.03 - UNACCEPTABLE BEHAVIOUR**

In order to protect the interests of the sporting community, the following actions may also be penalised by the O.O.D., by the UIM Executive Committee or by the NA of the Licence Holder.

- any deliberate act taken to gain unfair advantage.
- any false act made or statement given with the intention of suppressing facts required for the proper conduct of the race.
- any attempt to bribe or the taking of a bribe.
- any abusive or unsportsmanlike behaviour.

### **406.04 - REPRIMAND**

A Reprimand is a notice of disapproval of an unacceptable action. It must be recorded by the Race Secretariat. A reprimand must be witnessed. A reprimand automatically constitutes warning that if the offence recurs, a heavier penalty will be given. A Reprimand is valid for 12 month.

A reprimand can be given by the O.O.D., or the National Authority of the Licence Holder.

## 406.05 - YELLOW / RED / BLUE CARDS

A yellow or red card may be given by the O.O.D./**UIM Race Director** or UIM Commissioner.

A yellow or red card will be confirmed on UIM form which will be posted with the results and if it is confirmed it must be included in the commissioners report.

The driver has one hour from the posting of the penalty to protest (rule 403). If the protest is not upheld he can make an appeal (rule 405).

A yellow/red card received in all UIM disciplines and classes count towards the drivers CV and shall be accumulated.

Yellow/red cards can only be given for bad behaviour on the water including:

- up to two yellow cards at a time for dangerous driving;
- one red card for extreme blatant dangerous driving.

A driver who receives a red card is immediately disqualified from that event.

Receiving a third yellow card equals to a red card and carries the same penalties/actions.

A driver with a red card shall lose the right to take part in any UIM activities on the water for two months.

In addition during the two years following the receipt of the card, he is not eligible for the first UIM titled race in the discipline or class in which he received the card. Further penalties may be applied on a national level by the driver's NA.

All yellow cards will remain valid for the four UIM events (any UIM sanctioned races, titled or not) in which he competes following the date on which the last yellow card was delivered or 36 calendar months from this date.

Yellow/red cards must be notified to the UIM and driver's National Authority within three days of completion of the event.

The UIM will notify all National Authorities when a driver has a red card and is therefore suspended from international competition.

To be applied to all people in the paddock **and to UIM competitors also out of competition:**

A blue card can be given by the UIM commissioner/ **OOD/ UIM Race Director** for any offensive, unsportsmanlike, **abusive** etc, behavior during **an event. Two blue cards may be given for blatant and unlawful misconduct.**

**Blue card(s) can also be given by the relevant UIM Commission or Committee, by the UIM Executive Committee or by the NA of the competitor for any offensive, unsportsmanlike, abusive and herby unlawful behavior committed in the media or in any other way vis a vis the public and in relation to UIM, UIM officials, promoters, local organizers.**

**A blue card will remain valid for one year from the date of issue.**

**A second blue card leads to disqualification (if issued against a driver) from all results obtained at the event where the incident occurred and to suspension from the rest of the event during which the second blue card was issued.**

**If the second blue card is given for out of competition activity the penalty will be prolonged suspension according to rule 406.08 for one future event, designated by the same body that issued the second blue card.**

#### **406.06 - DISQUALIFICATION**

Disqualification deletes a competitor from the results of the heat or race where the offence occurred.

Disqualification is done by the O.O.D.

#### **406.07 - TEMPORARY SUSPENSION**

Temporary suspension suspends a competitor, a competitor together with crew, a crew member, or an Official from all or part of an event. Temporary Suspension may be given for serious indiscipline. Temporary Suspension will be imposed by the O.O.D.

#### **406.08 - PROLONGED SUSPENSION**

Prolonged suspension can be imposed on a competitor, an Official or an organisation for deliberate fraud, repeated or very serious indiscipline or very serious misconduct.

Prolonged Suspension can be imposed only by the NA of the licence holder or organisation, or by the UIM Executive Committee.

A Prolonged Suspension is always international. The NA must immediately inform the UIM of a Prolonged Suspension and the UIM must inform all other NA's.

#### **406.09 - EXCLUSION**

Exclusion means a permanent loss of all rights to take part in any activities falling under the UIM and its affiliated organisations. A person or an organisation who has committed a moral or sporting offence of extreme gravity is liable to be excluded.

A sentence of exclusion can be pronounced only by the NA of the licence holder or organisation, or by the UIM Executive Committee.

Exclusion is always International. The NA must immediately inform the UIM when it has imposed a sentence of Exclusion and the UIM must inform all other NA's.

In the case of suspension, prolonged suspension or exclusion, all National Authorities and therefore their affiliated clubs bind themselves to respect the decision and apply it in their own country.

### **407 - PRIORITY OF THESE RULES**

The course of the UIM has to be exhausted, before the dispute can be brought before civil court.

## **408 - POWERBOAT PROTEST FORM**

### PART A

Is for you, the driver, to complete and hand in within the specified time limit.

### PART B

Is for you, the driver, to complete and give to the Protest Jury Chairman at the beginning of the Jury Meeting.

### DRIVERS PROTEST FORM

#### PART A

##### SECTION 1

NAME OF EVENT: \_\_\_\_\_ DATE OF RACE OR HEAT: \_\_\_\_\_

HEAT NUMBER: \_\_\_\_\_ CLASS: \_\_\_\_\_

##### SECTION 2

YOUR NAME (PROTESTOR) : \_\_\_\_\_

YOUR BOAT NUMBER: \_\_\_\_\_ BOAT NAME \_\_\_\_\_

##### SECTION 3

I (the Protestor) am protesting against: (tick ✓ as appropriate)  To seek correction from the Race Organising Committee for actions or omissions.

Another driver, name: \_\_\_\_\_ Boat No: \_\_\_\_\_

The Results as posted

##### SECTION 4

Which rule has been infringed: \_\_\_\_\_

Time of incident: \_\_\_\_\_

On which lap was the incident : \_\_\_\_\_

Where was the incident: \_\_\_\_\_

What is the desired result of protest : \_\_\_\_\_

##### SECTION 5

Your signature \_\_\_\_\_ Time of signature \_\_\_\_\_

##### SECTION 6

You must see this section completed by the official receiving this Protest:

Name of Official: \_\_\_\_\_

Time Protest received: \_\_\_\_\_ Protest fee received \_\_\_\_\_

### PART B

#### SECTION 7

Either, explain incident with another driver in writing and by drawing; or, explain your reason for Protesting against the Race Committee:

## **409 - ARBITRATION**

### **409.01 – GENERAL**

A party of the appeal procedure has the right to ask for a final arbitration at the CAS (Court of Arbitration for Sport). The commencement of the arbitration procedure requires the acceptance of the mandate by the CAS. In the event that the CAS refuses to accept the mandate for arbitration the decision of the UIM International Court of Appeal remains final. The CAS procedure must abide by the following rules.

### **409.02 - PARTIES OF THE ARBITRATION PROCEDURE**

- The UIM will be party of the arbitration procedure and will be represented by the chairman of the UIM International Court of Appeal.
- Any other party of the appeal procedure shall be notified of the arbitration procedure and may join the arbitration procedure as party by written declaration to the UIM office or directly to the CAS.

### **409.03 - DEADLINES FOR ARBITRATION**

The intention to ask for arbitration must be notified in writing to the secretariat of the UIM by the interested party within 7 days of the day following the notification of the appeal decision.

A written justification for the claim for arbitration must be received by the Secretariat of the UIM within 14 days from the day the intention to ask for arbitration was received by the UIM secretariat.

The notification and the justification must be signed by the party.

### **409.04 - FEE AND COSTS**

The UIM arbitration fee is 1.525,00 EUR. The CAS may decide to refund/ partly refund this fee according to rule 405.10.

Regardless of the final outcome of the arbitration procedure all costs arising out from the arbitration by the CAS (e.g. invoices from the CAS or from experts mandated by or on the initiative of the CAS, travel, accommodation and communication costs of the UIM representative or similar) are borne by the party who asks for arbitration unless differently foreseen below.

This party must deposit an amount that covers all such possible costs no later than 14 days after being notified of the amount. The Secretary General has to determine this amount after consultation with the CAS and taking into consideration an amount of 2.290,00 EUR for possible costs arising to the UIM. The deposit has to be paid by bank transfer the UIM or directly to the CAS as determined by the UIM Secretary General. If during the procedure further costs arise, the party who asks for arbitration has to deposit the missing amount accordingly within 14 days from notification.

A party according to rule 409.02. b. bears the costs that arise from the performance of its rights as party of the arbitration procedure including but not limited to travel and accommodation costs, consulting fees and similar.

### **409.05 - FURTHER PROCEDURE**

The CAS will be mandated by the parties involved but only through the UIM secretariat. The UIM will assist the party by drafting and transferring the mandate to the CAS. The UIM must not transfer any mandate to the CAS unless the arbitration documents and fees according to rules 409.03 and 409.04 will be received in due time.

If the interested party misses any deadline, this party loses the procedure and the decision of the UIM International Court of Appeal will be automatically upheld. The UIM secretariat in this case will not submit the mandate to the CAS or withdraw any mandate that might have been submitted. In this case the interested party has to pay 50% of the arbitration fee and any costs according to rule 409.04.

The further procedure shall be determined by the CAS.

### **409.06**

The decision of the CAS will be final and it shall not be subject to any further jurisdiction.

## **500 - INTERNATIONAL SERIES AND CLASSES**

### **500.01 - DEFINITIONS**

The general racing rules and the rules governing records are applicable to all international series. By boat we understand any vessel used in powerboating (hydroplane, monohull, catamaran etc....).

A boat is a vessel that floats on the water when stationary and continuously derives support, directional control or propulsive effort from hydrodynamic forces.

### **500.02 - INTERNATIONAL SERIES AND CLASSES**

The following example serves to clearly define the words "series" and "class":

The series of Racing Outboards is divided into twelve capacity classes being: 125 cc, 175 cc, 250 cc, 350 cc, 500 cc, 700 cc, 850 cc, 1000 cc, 1500 cc, 2000 cc, 3000 cc and ∞ cc.

Low emission outboard racing engines are divided into following power (HP) classes: 15 HP, 30 HP, 60 HP, 90 HP, 140 HP, 250 HP.

The request to accept any new international series or class has to be presented by at least three National Authorities.

All series and classes for which the rules have been drawn up by UIM are international.

All national bodies are bound to observe these rules without any alteration whatsoever. Only UIM has the right to change the rules.

### **500.03 - RECOGNISED SERIES AND CLASSES**

All national series and classes for which the rules have been properly established by a National Authority are recognised by UIM.

### **500.04 - ENTRY LEVEL RACING CLASSES**

UIM proposes to establish, in each National Authority, Junior classes (as from 12 years of age) in conformity with the national legislation.

UIM will publish the list (unrestrictive) of classes already in operation.

UIM reserves the right to propose other classes and to draw up, whenever required in the future, international rules permitting competition between countries.

## **501 - MEASUREMENT CERTIFICATE**

A boat is not allowed to take part in an international race without a measurement certificate, issued by a National Authority, made up in the native language and in English according to the official UIM model. It can be renewed without re-measuring, provided the rules for the relevant class have not been changed.

The UIM establishes and maintains a "Group of International Measurers," consisting of persons from any NA that are fully qualified to measure boats for international racing classes. All NAs are asked to forward the names of persons qualified for this group. The UIM will name a chairman for the group who will be responsible for checking and certifying the ability of each member of the group.

If a boat owner's NA does not have a measurer qualified to measure his particular boat/class, the owner may ask his NA to contact another NA to have their fully qualified measurers inspect his boat.

When measuring a boat with a reinforced cockpit, all specifications in rule 509 must be checked including with driver in the boat and the to-do-list must be clarified, and rechecked and signed by a technical officer.

This rule does not apply to P750 Class.



**501.01**

Each National Authority stipulates the cost of measurement and the duration of the validity of the certificate.

The request to obtain a measurement certificate must be accompanied by the homologation file of the motor, if such is requested for the devices being used.

**501.02**

Any owner who has made alterations affecting the measurements in the certificate must notify his National Authority at once. Non observance of this rule invalidates the certificates. The National Authority re measures the boat at the owner's expense. Any boat that has been altered but not re measured is not allowed to race.

**501.03**

Any international measurement certificate must be as described hereafter, and must be adopted and used by all National Authorities and the UIM.

Measurement certificate form has to include the cockpit registration number, Crash box information and upgrade information.

**501.04**

The serial number of the motors may be omitted in the measurement certificate.

<b>UIM</b> Union Internationale Motonautique		<b>NA</b> National Authority	
<b>MEASUREMENT CERTIFICATE</b>			
NUMBER	CLASS	SERIE	
Owner _____			
Club _____			
Boat Name _____			
Measurer _____			
National Authority _____			
Date _____		Valid till _____	

HULL					
BUILDER _____		YEAR _____			
DESIGNER _____					
MATERIAL _____					
LENGTH	BEAM	WEIGHT	COCKPIT		
			LENGTH	BEAM	DEPTH
<b>SAMPLE</b> ENGINE					
BRAND _____					
TYPE _____		YEAR _____		N° _____	
HOMOLOGATION N° _____					
SPECIFICATIONS					
CYCLE		N°			
CYLINDER		N°			
BORE		mm			
STROKE		mm			
CYLINDER VOLUME		c m <sup>3</sup>			

**501.05**

No blank certificate may be issued by National Authorities. Documents must be completely filled in with all particulars pertaining to the series for which the boat is measured. The certificate must also be signed and stamped by the National Authority.

**501.06**

Drivers need only supply and measurers need only check such particulars as are applicable to the class of boat.

**501.07**

Anyone involved in the design, building (manufacturing or marketing) of a hull or motor in any other way has an interest in a certain boat is not to measure the boat.

**501.08**

All measurements should be taken at least twice. Measurements should remain within the limits provided for on the homologation sheet.

**501.09**

The owner of a vessel pays all fees and expenses for measuring his boat and/or motor(s).

The measurement certificate is only to be handed over when all dues have been settled by the owner to the National Authority.

**501.10**

When a re measurement is made at the request of the National Authority, the expenses and fees for such re measurement are paid by the National Authority if the first measurement is upheld.

**501.11**

A log book is mandatory for all boats equipped with reinforced cockpit, to be filled out by the race scrutineer indicating the race location, date, and if any damage occurred to the cockpit or boat. It will be part of the measurement certificate. In classes where a log book is required, the use of the UIM Digital Log Book and Measurement Certificate is approved. The DLB is now implemented in F1, F2, F4, S1, S2, S3, FR1000, F500 and O700 and mandatory in these classes.

In due time the Digital Log Book (DLB) will be made mandatory in UIM International class(es) by the UIM Council. A uniform text for all disciplines is as follows:

1. Any International or National race in which boats registered with a DLB participate, the DLB must be updated according to the events in the race and all To-Do lists must be cleared, with a signature and stamp from the NA or International Measurer before the boat takes part in a race. If the event is not covered by a UIM Technical Commissioner, the NA must upload the required information to the appropriate boats' DLB. If the NA is not capable of uploading the information, scanned copies of all the information and an entry list must be sent to the UIM Offices for uploading/updating the DLBs.

2. The Measurement Certificate duration is set by the National Authority date but must be updated following any of the below occurrences:

- a. Change of ownership.
- b. Change of boat dimensions and/or structure, or major repair after an accident or any other reason.
- c. If an NA wishes to remeasure the boat, the NA must either upload the information to the boat's DLB or scan and send signed measurement results to the UIM Offices for uploading/updating the DLB
- d. Rules for particular boats are changed

For GT15 and GT30, a UIM GT Measurement Certificate/Log Book is mandatory.

**502 - REPAIRS**

Repairs are permitted. The substitution of parts (except crankcase) is permitted but must be done under supervision of a technical officer. In those classes where the engine(s) or motor(s) are restricted, such substitution is only to be effected with original parts (Unless otherwise permitted in specific rules for the relevant class). Should it be necessary to effect the repairs outside the controlled area, this must be done under supervision of a technical officer.

In multi-heat races a complete engine change is possible: then if it is before time trials no penalty. If after time trials, start low end of jetty. If after first heat or more, all points gained are removed. Start next heat with zero points.

For any entry to remain valid, it is prohibited to change the crankcase, the boat/hull or it's sponsons after qualifying/time trials/race/heats.

If, for any reason, the crankcase or boat/hull is changed at any time, all points and positions are totally discarded. It then becomes a totally new entry and must go through the same scrutineering processes within the rules. In multi-heat races the boat must then start from the lower end of the jetty.

Any outside assistance on the race course, for repairs or any other reason, except for safe recovery reasons, are banned and could lead to disqualification.

## **503 - INSPECTIONS**

### **503.01.1 - GENERAL**

Hulls, motors, fuel, accessories and equipment, subject to restrictions regarding dimensions or other characteristics, must be submitted for verification.

It is compulsory for a driver to make arrangements (tools and special tools and mechanics) so that his motor can be disassembled if the Technical Officers at a postrace inspection want to check any part of the motor.

Both driver or/and mechanics shall work as efficiently as possible so that inspection duration can be kept to a minimum.

Drivers are at all times responsible for the condition of their boat (hull, motors, accessories, equipment, etc.).

Errors, if any, on the part of the manufacturer, builder, mechanic or even the previous owner do not justify non conformity with the rules.

### **503.01.2 - PENALTIES**

A driver who does not comply with the decisions or instructions given by the Technical officers, or who infringes any rules which it is the duty of the technical officers to check is not allowed to start in the race, or should he have raced shall be disqualified and reported to his National Authority, for possible further penalties.

A breach of the technical rules, will result in a disqualification from the entire race or heat. Exception is that lost or broken engine parts, required by rules or homologation, result in disqualification only for the relevant heat if repaired or replaced for subsequent heats.

Foreign drivers are to be reported to their own N.A. through the N.A. of the organising country.

Each N.A. must then inform UIM of further penalties, or reasons why no further penalty has been given by his N.A.

A driver who refuses his boat and/or motor to be inspected after a **heat or race results in disqualification**.

If this occurs at an international titled event, a mandatory penalty will be that the driver will lose his right to participate in international events for 12 months.

Driver(s) and racing boats must stay available at the race site until the technical scrutineering is ended and penalizing and protest times are over. Leaving of driver(s) and boats is allowed by OOD or Race Director permission only. Unauthorized leaving leads to disqualification of the driver's results from the race.

### **503.01.3 - PERSONS ALLOWED TO ATTEND THE INSPECTION**

- The Officer of the Day
- The delegate of National Authority of the driver who's boat/engine is being scrutineered.
- The measurers named by the organising committee
- The driver and maximum two mechanics if necessary
- The UIM Commissioner(s)

The presence of other persons is only allowed if authorised by the Officer of the day.

## 503.02 - PRE-RACE INSPECTION

At every race meeting all race boats must be inspected before going in the water due to safety reasons, and as a help to the inspectors they may use the recommended minimum check list.

	UIM art.
Boat number	206.02.
Life jacket	205.06/509.04
Crash helmet	205.07
Lifting eyes and slings	205.12
National flag	206.01
Boat number on boat deck and under cockpit	206.02/509.19
Mooring eye	504.01
Paddle (not required in boats with reinforced cockpits)	504.01
Flotation	504.01/509.02
Throttle & ignition cut off	504.03
Steering drum and steering cables	504.05
Rigging of fuel systems	504.05
Rigging of electrical systems	504.05
ID plate on cockpit	509.01
Seat belts and belt buckle (check for wear)	509.03
Driver fitting in cockpit	509.05
Water deflector	509.07
Prop guard	205.10
Energy absorbing padding in cockpit	509.08
Sharp edges in cockpit	509.09
Removable steering wheel	509.10
Air Supply	509.20
Rear view mirrors	509.11
Motor shut off switch outside of cockpit	509.12
Air vents	509.14
Water inlet holes in back of boat	509.15
Bottom of cockpit coloured orange	509.19
Oil absorbing carpet	703
Main power switch (electrical)	Formula Rules
UIM Sticker for all titled events	Formula Rules
Oil	508.07
Fin to lean out from the keel fixed system check (without reinforced cockpit)	522.03

Drivers must be able to show:

- a valid license;
- a valid measurement certificate for the relevant class;
- a copy of the boatbuilder's UIM registration for reinforced cockpits;
- a valid immersion training certificate (§ 205.05) for boats with reinforced cockpits;
- a manufacturers certificate of a restraint system (509.03)
- for drivers with a physical handicap, a doctors written approval that the driver may race (mentioning any special conditions).

If during pre-race inspection a boat/engine/equipment is judged to be in violation of the rules, the driver **MUST** be informed and must be given the opportunity to correct any problems.

Special attention must be paid to the automatic engine shut-off and that the racing number conform with the rules.

Upon completion of a race the engines must remain sealed to prevent any alterations being made. After the pre-race technical inspection, the boats must not leave the boat park except for practising or racing.

### 503.03 - INSPECTION AT RACE

At any time during an event, the technical inspector, the O.O.D. or the UIM Sport/Technical commissioner reserves the right to change a competitors existing ECU/CDI unit with a standard OEM unit as supplied by the UIM.

If a competitor refuses this request, they will be immediately disqualified from the event, without right of protest.

Technical inspectors have the right to carry out all the checks they consider necessary, even when inspection has taken place before practice, and they have the right to inspect as they think fit.

### 503.04 - AFTER RACE INSPECTION

#### 503.04.1 - GENERALLY

The first 3 (three) boats classified in each class (for classes with low emission engines six boats) must go directly to the "parc ferme" for relevant inspection immediately and directly after the end of the final heat. Any visit to their respective pits during this move will result in disqualification.

Any attempt to make changes to the engine or the hull after race and before starting of technical inspection entails disqualification from whole event by the decision of O.O.D. or UIM Commissioner. Only persons defined in 503.01.3 are allowed to attend at post race inspection.

When winner(s) are already known before last heat(s), these classified boats must go directly to the "parc ferme" immediately and directly after the end of the relevant heat. These drivers can prepare boats for the following heats and join the following heats under strict supervising of the Race Technical Officers and escorting to the jetty and back to the "parc ferme" after the heat. Maximum two mechanics per boat are allowed to attend to the "parc ferme" with the driver for preparing boat for the race.

"Parc ferme" is a well-defined place, where engines and boats will be placed pending inspection and which remains under the control of the race officials.

After the race, the first classified boat and engine must be measured by the Technical Officer. Technical inspectors have the right to carry out all the checks they consider necessary, even when inspection has taken place before practice, and they have the right to inspect as they think fit. A sufficient number of boats must stay in the "parc ferme" until the winner is established.

The driver must report with his boat at the inspection and must comply with the rules of the organising race committee.

The post-race inspection should be about speed and power enhancing matters.

At the discretion of the UIM Commissioner or of the Technical Commissioner a dyno test or other specific laboratory tests, may be required as a part of the post-race scrutineering.

The Technical Commissioner, at his discretion, will:

1. Seal other parts of the engines;
2. Put his signature on critical removal parts;
3. Take pictures of critical parts;
4. Collect engine oil/fuel samples;
5. Keep the ECU under UIM jurisdiction;
6. Require the engines and equipment to be sealed in the presence of a UIM official in shipping crates or boxes supplied by the team;
7. Agree with the Team representative on follow-up issues.

### **503.04.2 - MOTOR INSPECTION**

Verification of motors in restricted series is carried out according to the facts contained in the homologation file.

At world record runs, world championships and continental championships, inspection of the winning motor is compulsory. Inspections may also be done whenever found necessary at all international.

At all Continental and World Championship events hosting "low emission" engines a technical representative of each brand of engine entered may be enlisted to provide electronic verification of legality to the Chief Technical Inspector of the event. The representative must report exclusively to the Chief Technical Inspector.

The following procedure is mandatory for these inspections:

1. Check that the motor type code and visual appearance conforms with the motor homologation sheet.
2. The measurements stated in the homologation sheet must be checked on the motor. If the results are within the specified tolerances the motor should be accepted as legal. Only adjustments to meet dimensions shown in the homologation sheet are allowed.
3. When ports in cylinders are adjusted to the dimensions specified in the homologation sheet, material may only be removed in the specified opening to a depth of 10 mm, to match the shape of the original adjacent connecting passage (channel) outside the adjusted port opening. This also applies to other openings in the motor for which the dimensions are specified in the homologation sheet. **For two stroke engines, ports in the cylinder shall be measured 1 mm in from the cylinder wall surface if nothing else is stated in the homologation file.**
4. Parts not specified with measurements in the homologation sheet shall only be checked by visual comparison with standard parts. As the actual manufacturing tolerances are not published, small differences between the inspected part and the reference part must be accepted.
5. Cylinder dimensions and compression volume are measured when the motor is cold. Allowance is made for the carbon and oil present in the combustion chambers. Checking is to be done with oil. A large scale graduated cylinder or burette with adequate orifice is to be used.
6. Inspection procedure for the low emission engines will also be clarified in the homologation sheet.

## **504 - EQUIPMENT - PEOPLE ABOARD-MOTORS**

### **504.01**

Every boat must be fitted at the bow with a towing eye, and every reinforced cockpit boat must be fitted at the bow with two mooring eyes, one at the top and one at the bottom which must be strong enough to support the boat if it sinks and to make towing possible.

One or two oars or adequate paddles, adequately secured and stowed, so that they are immediately available, are to be on board. Boats with reinforced cockpits do not need to have oars or paddles.

In F-classes up to and including F350 and OSY 400, the surface of the paddle should be cm 30x15 and the colour of the paddle shall be yellow or orange, or similar fluorescent colour. This is to be used as a warning signal.

Every boat must have adequate buoyancy to ensure that it floats in case of an accident. This buoyancy shall be equivalent to a volume of 0.055 m<sup>3</sup> of foam per 100 kg. of boat weight.

For catamarans the required volume must be 0,025 of foam per 100 kg of boat weight. If a reinforced cockpit is fitted, at least one half of this volume must be securely attached to the cockpit structure. Any foam is to have a maximum density of 30 kg/m<sup>3</sup>.

The flotation provided by the airbag is not to be included in the calculation for required flotation.

At all times for any boat the throttle must be able to return to the idle position unaided. Fixed throttle for the start is prohibited.

## 504.02 - WINDSCREEN

Boats must be uncluttered and the windscreen if fitted must be easily removable to present no obstacle to the driver getting free, and to not impede lifesaving and salvage operations.

The edges of the coamings and the windscreen must not be sharp and must be lined with rubber or other similar material to avoid injuries in case of accident.

## 504.03 - AUTOMATIC THROTTLE SHUT-OFF

All boats must be fitted with an efficient automatic throttle shut-off device as well as an automatic device in the ignition circuit which will stop the motor if the driver is thrown out.

Boats with reinforced cockpits do not need to be fitted with this kind of ignition shut-off device.

The device must be clearly visible, as must be the link to the driver. The link must be short enough to be efficient.

The system must be working at all times during a race, practice or trials.

A driver who does not conform is disqualified in a race or is made to pay a fine **of 200 EUR** in case of practice or trial runs. Lanyard connection to the life vest is required to shut off the fuel on boats with electric fuel pumps.

## 504.04

During a race, the boat must have onboard all the equipment required by the Race Committee in the detailed instructions contained in the advance programme.

## 504.05

All, and every relevant attachment, must be securely bolted to the hull.

It is mandatory for all classes up to 50hp and "F" classes up to and including F700, F4 and HR1000 that the steering cables must be made of marine grade, flexible stainless steel wire 7 x 19 with a minimum diameter of 4.00mm (5/32"). All shackles and turnbuckles in the steering system must be lock-wired with corrosion resisting steel wire and only self-locking nuts may be used in the steering system.

As an alternative to wire rope steering cable, high-strength, low stretch braided rope may be substituted. This rope may have a smooth, braided outer covering over a high strength, low stretch core or be a high performance single braid line. Core materials can be Technora, Dyneema, Spectra or similar. Carbon fiber not allowed. Minimum nominal diameter will be 4mm or 5/32 inch, minimum breaking strength 7000 N. Rated stretch should be under 3%. Ropes of this type are used for running rigging for sailboats. Since verifying these specifications would put an onerous burden on the safety scrutineer, any boat using rope for steering must be able to present documentation on the rope used as well as a sample for his inspection.



**504.06**

In all series, there must be only one driver per boat.

The Race Committee may rule otherwise in the advance program for long distance races.

**504.07 - PISTON MOTORS**

Reciprocating piston motors are to be fitted on boats of the international series.

The total cylinder capacity of the motor or motors forms the basis for eligibility in the corresponding classes.

The motors may be of the two stroke types. They may have carburettor(s) or fuel injection.

**504.08 - ROTARY MOTORS**

Rotary motors with trochoidal rotors are admitted on the basis of an equivalent cylinder capacity.

The rotary motor capacity is twice the volume determined by the difference between the greatest volume and the least volume in the working chamber.

**504.09 - SUPERCHARGING**

When the motor includes a device used for supercharging it, the nominal cylinder capacity is to be multiplied by 1.4, and the boat will pass into the class corresponding to the calculated volume resulting from this operation. The supercharger must be a standard part of the motor. A dynamic air inlet for ducting the atmospheric air toward the motor's air intake is not considered as a supercharging device.

**504.10 - FINS**

Fins are not allowed to be retractable underway.

**504.11 - ELECTRICAL ISOLATION**

All boats, with batteries, must have an isolation switch as close to the positive terminal of the battery(ies) as practicable (negative terminal if positive earth system).

The opening handle of the switch must be easily accessible on the deck or other surface of the boat on the port side to 1 meter maximum rear the driver (rear reinforced cockpit)

This switch must be marked with a red flash + and the "On/Off" positions shown.

**504.12 - BALLAST**

These ballast rules are valid for all Circuit classes excluding the classes with specific rules for ballast (Formula Future) which are already applied.

The ballast must have the necessary strength to remain fixed where positioned.

The ballast must be on the inside of the hull fixed with clamping suitable for the race.

It must be possible to remove ballast for inspection.

The maximum allowed ballast weight is 10% of the specified minimum weight for each individual class (mentioned in the rules for each class);

For the classes where there are mentioned the minimum weight of the boat and the minimum weight of boat with driver, the maximum allowed ballast weight is 10% of the specified minimum weight without driver to reach this minimum weight, plus possible ballast weight that is necessary to reach the specified minimum weight with driver.

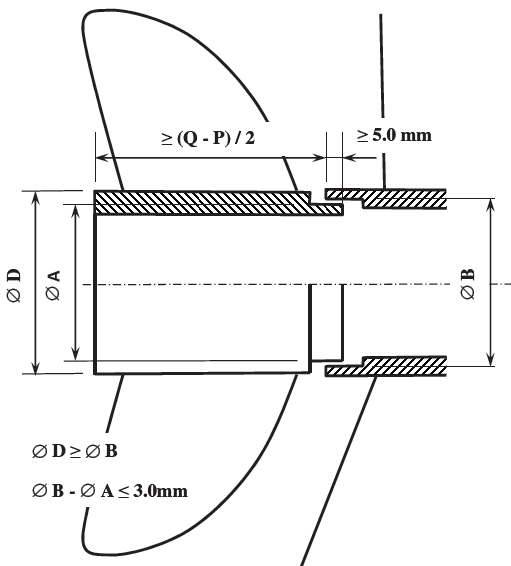
### 504.13 - PROPELLERS WITH EXHAUST TUBE

Gear cases with a propeller exhaust must use propellers equipped with an exhaust tube. Requirements for propeller equipped with an exhaust tube for gear cases with through propeller exhaust.

1. The length of the exhaust tube measured from the gear case to the end of the exhaust tube must at least be  $(Q - P)/2$ , where measure Q and P are taken from the homologation file of the relevant engine
2. Propeller exhaust tube outside diameter must at least equal to the inside diameter of machined recess into which the standard propeller boss fits at the rear of the gear case.
3. The maximum allowed radial clearance between the exhaust tube and the machined recess of gear case, measure as diameter, is 3.0 mm.
4. The exhaust tube must enter the machined recess of the gear case by a minimum of 5.0 mm.
5. No spacing of the propeller to allow venting of the exhaust gases around the propeller is permitted.
6. No holes or ventilation slots of any type are allowed in the exhaust tube.

### 504.14 AUTO PILOTS

All moveable surfaces allowed on the boat shall be under the control of the onboard crew without any sensors in the control loop (i.e. no auto pilots, auto trims, gyros, accelerometers or other attitude or acceleration sensors may be in the control system).



## **505 - NOISE REDUCTIONS**

### **505.01**

The use of an efficient device to attenuate the noise is compulsory.

A race organiser shall have at hand a sound level meter as described below as well as personnel trained in its use.

It is recommended that associated National Authorities obtain such meters and lend them to race organisers when needed.

### **505.02**

The noise level must not exceed levels listed below, except for A- and TR- serie boats.

### **505.03**

The noise level is measured by means of a precision sound level meter which conforms to the specifications laid down by I.E.C. and A.N.S.I, using the "A" weighting and set to slow response. The registering microphone is placed at a distance of 25 m 90 degrees to the course of the boat with no interfering objects within 25 m.

The boat must pass the microphone at top speed.

The measurements must be carried out while the boat approaches the microphone and while moving away from the microphone. The measuring must start when the boat is minimum 100 m before the closest point on the course to the microphone and continue until the noise level has dropped considerably from the measured value.

Neither of the measurements is to exceed 91 dB(A) with a 2 dB(A) tolerance for motors up to 750 cc, and 91 dB(A) with a 4 dB(A) tolerance for motors above 750 cc.

Only for motors up to 750 cc, without water pump

If the above method is not practicable, reference measurements may be made with the boat on dry land, the motor running under no load at a mean piston speed of 13 m/sec. The microphone must be placed 0.5 m from the exhaust orifice and at a height of at least 20 cm above the ground. The maximum noise level, using a meter as above is to be 101 dB(A) with a 2 dB(A) tolerance. This level is experimentally determined and may be changed.

## **506 - ENGINE HOMOLOGATION**

### **506.01 - RESPONSIBILITY**

COMINSPOORT controls the homologation process and appoints a POWERTRAIN committee to carry out the various processes. POWERTRAIN is composed of persons appointed from the membership of COMINSPOORT and COMINTECH and, if needed, outside experts.

All engines in standard engine classes must be homologated.

### **506.02 - PROCESSES**

UIM establishes two processes depending on the entity initiating the homologation request.

#### **506.02.01 - PROCESS #1**

An engine manufacturer applies for an engine homologation for competition in certain UIM classes.

#### **506.02.02 - PROCESS #2**

COMINSPOORT or COMINOFF requests homologation of an engine for competition in certain UIM classes.

### **506.03 - HOMOLOGATION APPLICATION - PROCESS#1**

Engine manufacturers are invited annually to apply to the UIM for engine homologation via their affiliated UIM National Authority of the country of engine manufacturer. Homologation application must be made using the electronic homologation forms available from the UIM Secretariat.

### **506.04 - MINIMUM PRODUCTION QUANTITIES**

The required number of engines manufactured prior to homologation is to be verified by the manufacturer and endorsed by the National Authority of the country of manufacture. If insufficient numbers of engines have been manufactured at the time of homologation, a written certificate, witnessed by a practicing lawyer, of the firm intention to manufacture the specified numbers is required from the manufacturing company which must clearly state the completion date of manufacturing schedule to meet the required minimum production numbers.

Minimum required quantity of outboard engines is 250 units.

Minimum required quantity of offshore inboard engines is (30).

In Process #2, no manufacturer statement or statement of intention is required.

### **506.05 - DEADLINE FOR APPLICATION**

In Process #1, Application for the request of homologation of an engine must be received by the UIM Secretariat by close of the last business day before the relevant year's GA, to be considered for validity commencing 1st April in the following year.

In process #2, COMINSPORT must direct POWERTRAIN to complete the homologation of a candidate engine at the COMINSPORT meeting during the General Assembly of any given year to be considered for validity commencing 1st April in the following year.

### **506.06 - APPROVAL OF APPLICATION - PROCESS#1**

An application for homologation, running production change or extension of validity will be considered by COMINSPORT (or, in the case of engines designated for use by the offshore category, COMINOFF). This commission will determine if the candidate engine complies with the rules of the class of racing for which the engine is designated (i.e.: availability, performance level, suitability).

Once an application for homologation, running production change or extension of validity of a candidate engine is deemed acceptable for a given class by the relevant commission, the inspection and verification procedure (or administration of the running production change or extension of validity) will commence.

### **506.07 - INSPECTION VERIFICATION PROCEDURE**

At a time and place agreed upon by the UIM COMINSPORT's Powertrain committee and the entity requesting homologation, a production example of the candidate engine; all its components; and any relevant inspection tools will be examined to complete and verify the declarations in the homologation file as applied.

This inspection must be completed before 1st April for the homologation to be valid for commencement in that year.

In Process #2, Powertrain will procure the example engine; examine it; complete the relevant documentation; and dispose of the engine (all at UIM expense).

The homologation becomes valid when all correct and completed documentation including the finalized homologation document has been received by the UIM Secretariat. This must be before 1st April for the homologation to be valid for commencement in that year.

### **506.08 - TERM OF HOMOLOGATION**

A homologation remains valid from the date of completion through to 31st December of the tenth year of validity.

### **506.09 - ANNOTATION OF VALID CATEGORIES**

The final homologation file will display the specific UIM power boating category(s) for which the engine is approved. The annotations will be made appropriately as follows:

- CIRCUIT
- OFFSHORE
- CIRCUIT/OFFSHORE

### **506.10 - HOMOLOGATION FILE COPIES**

The valid UIM engine homologation files in their latest update can be downloaded for free on the public area of the UIM website.

## 506.11 - RUNNING PRODUCTION CHANGES

Approval of application for running production change must initially follow the rules of 506.07.

An application for a running production change may be requested by a manufacturer at any time of the year, although its commencement will be dated from 1st April in the year applied for. Powertrain will confirm whether any requested change is acceptable as a running production change, or requires the engine model to be re-homologated. Modifications to specifications dictated by manufacturing or structural requirements are admitted, but not those primarily aimed at improving performance. (as a guide, any changes or accumulation of changes likely to increase power by more than 5%, or the speed performance corresponding to more than 5% increase above that given by the original homologation specifications, may be grounds for re-homologation).

An approved running production change will be announced on the UIM Website and will be deemed legal for use in racing 30 days after the official date of approval.

## 506.12 - EXTENSION OF VALIDITY

Extension of validity of an homologation is determined solely by COMINSPOORT or/and COMINOFF.

«The expenses of inspection are to be borne by the UIM in either process.

The verification inspector will be designated by Powertrain and his expenses (travel, hotel and meals) are to be reimbursed by UIM It will be COMINSPOORT's intent to minimize costs by designating the nearest capable person as the inspector for each candidate engine.

## 508 - FUEL

### 508.01

- 1) To maximise the equality of competition and to simplify the checking of conformity, organisers must arrange the supply of the same fuel for all competitors at all international titled events, except for classes F125 to F700 where the fuel is alcohol based (508.05). It does not of necessity have to be free of charge. It is also recommended for ordinary international events.

Organisers must announce in the advance programme.

The cost of fuel that they will be arranging, the octane number, the brand name of the supplier, and the logistic method of making it available, e.g. distribution tanker in the pits or organised shuttle service to a local fuel station operated by the local organiser. Drivers must provide suitable containers for such use, marked in accordance with appropriate international hazardous standards, and clearly marked with the boat race number.

Drivers must use the arranged fuel as provided and must not bring their own fuel to the event. Contravention of this rule will be penalised. Checks may be carried-out on arrival in the pits and during scrutineering.

### 508.02 - SPORTS ENGINE FUEL (S. T. P. E. - OSY400 - F1000 - F2 - F4 AND O CLASSES - O850 AND ABOVE)

- 1) Fuel will be unleaded automotive gasoline only for use in non-racing automobiles equipped with catalytic converters.
- 2) Fuel may also be intended for sport engines supplied to the organiser by an international fuel company.
- 3) Fuel will have a minimum octane rating of 95 RON.
- 4) All fuels supplied must be in conformity with the minimum requirements of the engine manufacturers

### 508.03 - RACING ENGINE FUEL (R CLASSES)

- 1) Fuel produced by an international company for motor sports use. Octane rating to be minimum 100RON maximum 104RON. Unleaded fuel is preferred.
- 2) Aviation fuel AVGAS 100LL, may be used. (No longer allowed in EEC countries).
- 3) All fuels supplied must be accompanied by a data sheet.
- 4) All fuels supplied must be in conformity with the minimum requirements of the engine manufacturers.

### 508.04 - DIESEL ENGINE FUEL

- 1) The fuel must be a commercial grade for automotive or marine use, as obtained from normal roadside or marine service stations.

### 508.05 - ALCOHOL BASED FUEL

- 1) The fuel must be Methanol (CH<sub>3</sub>OH) or Ethanol (C<sub>2</sub>H<sub>5</sub>OH)
- 2) The fuel may contain water (H<sub>2</sub>O).

Any changes to the above rule must have the first implementation date of at least 3 years from being passed by General Assembly.

### 508.06 - ADDITIVES

- 1) Only two stroke engines that are not equipped with mechanical oil injection systems will be permitted to use fuel with lubricating oil pre-mixed in it.
- 2) The use of environment-friendly oil is recommended in pre-mixed fuel / oil.
- 3) The use of any other additives is prohibited to either the fuel [carburent] or the air intake [comburant].

Any changes to the above rule must have the first implementation date of at least 3 years from being passed by General Assembly.

### 508.07 - RANDOM TESTING OF COMPETITORS' FUEL

- 1) Fuel samples taken at random from competitors during the event will be tested at the race venue, and may also be chemically analysed afterwards in the laboratory. The organizer must seal the sample of the fuel in a fuel approved can.
- 2) The entire installed fuel system may be dismantled, removed from the boat and inspected.
- 3) Gasoline supplied by an organiser will be tested at the start of an event to establish its test device value.
- 4) In the event that the organiser does not supply fuel and the competitors bring their own, each competitor's fuel will be checked. This will be part of the pre race scrutineering.
- 5) At an event where the competitor's fuel is used, it will be the competitor's responsibility to ensure that at least one litre of neat gasoline is always available for sealing as a sample.
- 6) Temperature of the fuel at the test cannot be lower than 5°C (9°F) from surrounding shaded air temperature.

### 508.08 - TESTING PROCEDURES

- 1) Gasoline fuel or fuel / oil mixture may be checked at any time using UIM approved equipment and procedures. Meters and equipment will be calibrated each time in accordance with the UIM fuel testing guidelines obtainable from the UIM Secretariat.
- 2) Alcohol based fuels will be tested in accordance with UIM current procedures. Density test will be performed on alcohol based fuels. Density of the fuel must be less than 0,820 kg/dm<sup>3</sup>.

### 508.09 - DISQUALIFICATIONS, PROTESTS AND APPEALS

- 1) Any competitor's fuel when tested, and judged as illegal, from timed trials, heats or races will be disqualified up to that time.
- 2) The legality of the fuel is to be judged only by the UIM Sport/Technical commissioner, or if he is not present at the event, by the technical scrutineer, based on all tests and information available to him at the time.
- 3) Any further infringement of these fuel rules will lead to immediate disqualification from the event, where the infringement occurred.
- 4) Repeated violation of these rules the UIM may sentence a stronger penalty.
- 5) Any disqualification must be followed by the sealing-up of two samples of the competitors fuel. Recommended amount of fuel by test labs - not less than 1 litre. No sample to be opened or disposed of unless the UIM inform accordingly.
- 6) If the competitor protests or appeals his disqualification, he will have the right to have the samples checked using Gas Chromatography, or similar tests to establish what components are present in the fuel sample. All costs incurred in this analysis will be paid by the competitor irrespective of the result.
- 7) If one competitor protests another competitor's fuel, there must be a factual basis for the protest, samples will be taken and tested. The protest must be accompanied by a fee of 250 E which may be used to defray the cost of the analysis
- 8) The result of the analysis which will confirm the presence of illegal additives or not, will be taken as final and cannot be appealed.

### 508.10 - REFUELLING

Refuelling is allowed only at places announced by the event organiser.

### 508.11 - STARTING AIDS

No chemical starter aids are permitted on the start pontoon except for alcohol based fuels.



## **509 - REINFORCED COCKPITS**

These rules provide only a minimum standard for reinforced cockpits. It is important that constructors continually develop cockpits beyond these minimum's and produce cockpits that exceed these standards.

A reinforced cockpit is defined as an enclosure for the driver of the boat.

It is defined as an enclosure with sides, a canopy (roof), a bottom, frontal area over the feet and legs, forward and rear bulkheads, flotation and windscreen. It also comprises the joining together of all these parts. The reinforced cockpit system also includes the restraint system, seating, control system and other systems as specified in these rules. The purpose of the reinforced cockpit is to attempt to protect the driver from the impact of other boats or water impact. It is not required to protect the driver from every possible incident.

The approved Newton standard for a cockpit is to be found from the cockpit registration number. A list of registration numbers and the corresponding Newton standards is available from the UIM Secretariat and the UIM website.

All new cockpits registered in UIM classes (Except F1 and F2) will be registered for 10 years provided they meet the 3000 Newton Test and other current relevant cockpit rules ; provided that Cominsafe, Cominsport, Comintech and the Cockpit Committee agree that there are no new technologies that would significantly improve the safety of the drivers in these cockpits. The mandatory implementation date of exceptions must be fixed by these commissions for each affected class.

### **FOR OUTBOARD CLASSES UP TO 1500 CC OR (90 HP EPA) AND OTHER COCKPIT BOATS**

Any cockpit of 1000 Newton must be updated to 2000 Newton by the addition of enough composite material, to have 2000 Newton cockpit,  $1000 + 1000 = 2000$ . It is recommended to upgrade cockpits to 3000 Newton.

Any cockpit registered but without a 1000 Newton certification must be upgraded to 2000 Newton by a registered 2000 Newton or higher certified cockpit builder with the addition of at least 2000 Newton of materials and the addition of his cockpit certification number stating if it is a 2000 Newton or 3000 Newton upgrade.

Cockpits built after January 1, 2015 must be constructed from a composite layup that meets the 3000 Newton standard.

### **FOR OUTBOARD CLASSES FROM 1501 CC OR OVER 90 HP EPA**

Any cockpit of 1000 Newton must be upgraded to 3000 Newton by the addition of enough composite material, to have 3000 Newton cockpit. All 2000 Newton cockpit boats are free to participate until further notice.

### **UPGRADING**

This upgrading on cockpit must at least be done on both vertical sides above deck, over the helmet area, over the leg area, the backplate, and the entire bottom. An approved cockpit builder who has passed the at least 2000 Newton panel test must do the upgrade.

Upon any upgrade completion, his cockpit registration number must be moulded or ground into the upgraded cockpit.

Cockpits must have two cockpit registration numbers, one for the original cockpit and one for the updated reinforcement. These two numbers must be written in the measurement certificate.

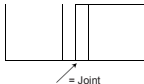
Cockpits built in 2002 and onward must have passed the 2000 Newton test.

Cockpits built in 2005 and onward, for outboard classes from 1501 - 2000 cc and upwards, must have passed the 3000 Newton test.

### **UIM COCKPIT TEST STANDARD**

#### **Sample Construction Requirements**

1. Sample quantity must be 3, one of which must include a sample of the joint/bonding of the cockpit halves, transverse to the length of the sample;



- Trimmed sample size must be 100 mm  $\pm$ 1.0 mm wide x 800 mm  $\pm$ 5 mm long, with the width being parallel;
- For fibre orientation the 800 mm length being parallel with the bottom surface of the intended homologated cockpit;
- Sample must be laminated on a flat surface using the same manufacturing process, materials and fibre orientation's as the intended homologated cockpit construction;
- The sample must have a uniform thickness with no core crushing along any edges;
- The sample must have one moulded face and the other face being un moulded, the moulded face will be taken as being the external surface of the cockpit during testing;
- The sample must be representative of the thinnest lay-up of the safety cell;
- The sample and cockpit must be manufactured using balanced or unbiased materials.

#### Sample Test Method

- The sample will be supported across its full width perpendicular to the 800 mm edges by two parallel 25 mm Steel bars at a distance of 500 mm apart. The load will be applied equally through two 25 mm Steel bars, each a distance of 167 mm parallel from each support;
- The moulded face of the sample will have the load applied and the un moulded face will support the sample;
- The load will be applied at 0.4 mm/sec and the deflection will be measured at the two 25 mm Steel bars applying the load within 2 minutes.

#### Sample Test Requirements

- The sample when loaded with a force of 3000N must have no more than a maximum deflection of 25 mm without the sample failing;
- The sample weight in gm/m<sup>2</sup> will be calculated, skin thickness and sample thickness will be measured to enable inspection and comparison of damaged homologated cockpits;
- Further non-destructive test analysis methods maybe used to compare test samples with homologated cockpits during the life of each cockpit.

#### Sample Manufacturing Information Requirements

- Ply laminating sequence (stating which ply is the moulded face);
- Ply materials;
- Ply weave styles;
- Ply material weight in g/m<sup>2</sup> (dry weight ie. without resin);
- Ply orientation (where 0° is parallel with the 800 mm edges);
- Core material and density in lbs/ft<sup>3</sup> or kg/m<sup>3</sup>;
- Manufacturing method (stating vacuum, pressure and temperature);
- A 100 mmx100 mm sample of all materials used (resin samples not required).

Samples as per sample construction requirements must be sent to the UIM appointed person.

### 509.01

Any boat having a reinforced cockpit (or closed cockpit of any type) must have equipment to restrain the driver (safety harnesses) per rules 509.

Any boat having a restraint system (driver harness) must have a reinforced cockpit complying with § 509, even if a reinforced cockpit is not mandatory in its class.

Matters relating to cockpits/deformable structures shall be dealt with by the cockpit working group.

Experts may be co-opted when required.

The manufacturer of any reinforced cockpit will submit his name, or company name if applicable, and completed UIM reinforced cockpit questionnaire to his National Authority. and thence to UIM, before that cockpit will be

allowed to compete. The manufacturer's name, type designation, date of manufacture and registration number must be permanently moulded into a visible place on or in the reinforced cockpit. If this is not moulded in, a scrutineer shall grind the UIM registration number, and the manufacturer serial number into the cockpit/midsection of the boat.

Cockpit structure must include securely attached flotation capable of floating the cockpit, driver, motor and any attached structure.

The National Authority of the manufacturer of the reinforced cockpit will receive an acknowledgement from the UIM office.

In the case of series manufactured cockpits, the letter will refer to the cockpit manufacturer and type.

## 509.02 - PICKLE-FORKS

A boat is allowed to race in a re-started heat/race without a deformable pickle-fork, only if it has been lost during the stopped heat/race.

All catamaran type boats must comply with the following : The main body of the sponson must end in a minimum 100 sq.cm forward bulkhead made of a minimum 8 mm thick plywood or equivalent material. This bulkhead must be an integral part of the main structure of the sponson and must have a rounded area of at least 10 cm length. See following sketch A.

The following will apply to outboard classes above 1500 cc, all other cockpit classes and any boat equipped with deformable pickle-forks.

Race boats of catamaran type, designed and equipped with pickle-forks, must have deformable and energy absorbing pickle-forks according to the following:

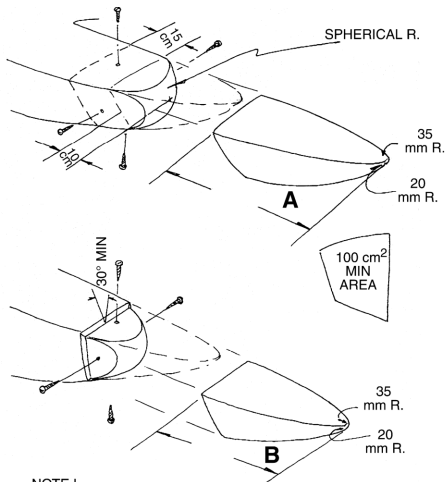
"The most forward end of the picklefork must be deformable and must be designed to crush.

"The deformation must start at a maximum of 100 kg.

"The pickle fork must:

- be detachable and have nothing inside
- have a front end of minimum horizontal radius of 35 mm
- have of front end minimum radius of 20 mm in all other directions "According to the following drawings"

Any hull fitted with deformable pickle forks must meet the minimum length of hull for its class which can include the full length of the pickle fork as fitted.

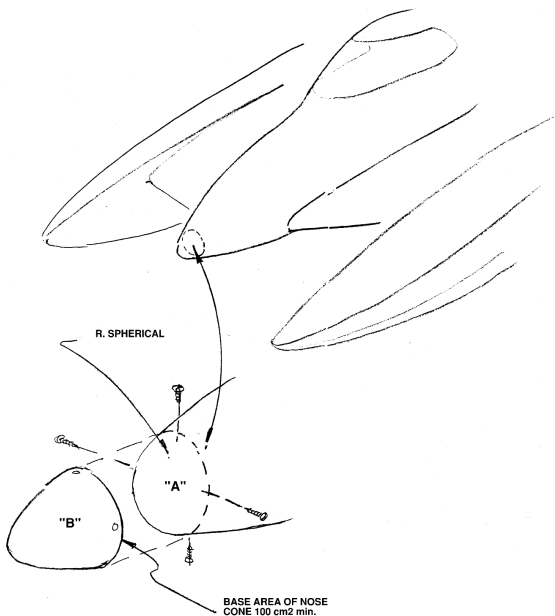


FOR ALL FORMULA BOATS  
EXCEPT F-500 DIMENSION  
A=50cm B=35cm  
THESE ARE MINIMUM  
DIMENSIONS.

FOR ALL OTHER PICKLEFORK BOATS  
A=40cm B=25cm  
THESE ARE MINIMUM  
DIMENSIONS.

The nose of the cockpit of boats built after January 1, 2001 must have the same minimum dimensions as the front of the sponsons before the collapsible picklefork.

If a collapsible front is used on the cockpit, it must have the same minimum dimensions as the picklefork.



- A. The front of cockpit must have the minimum radius as the front of the main body of the sponson, before the crushable picklefork.
- B. A deformable nose may be added to the cockpit but it must be detachable, have nothing inside, have the same minimum dimensions as the detachable picklefork and deformation must start at a maximum of 100 kg.

### 509.03

Any competitor driving an approved reinforced cockpit design boat will be in a restraint system consisting of a minimum 6 strap/6 point mounting system.

The certified (or recertified) minimum 6 strap/6 point mounting system must be replaced after 4 years for polyester restraint belts, according to the manufacturers recommended replacement interval, or after an accident that results in structural damage to either the cockpit or hull, or injury to the driver.

The manufacturer's certificate must be available and show the date of manufacture or recertification.

Not closing the belt in cockpit classes will result in a suspension for the 2 following races of the Series and for titled Championships run in one round, in a suspension at the next Championship.

Strap locations will be minimum two each hip, crotch, two-shoulder, all hooked together in a central release system. This release mechanism must remain released/open once it is activated and until it is reset. A high strength, highly visible, lanyard will be attached to the release lever of the lever/latch system. Belting shall be a minimum of 5 cm (2 in) width.

The driver harness attachments bolts in reinforced cockpits must consist of a minimum of 8mm bolts, 1.25 thread, stainless steel, and attached as per the drawings in rule 509.18. Also acceptable are 10 mm and 7/16 inch eye bolts, spec 8.8, supplied by the harness manufacturers. There must be a spacer and a washer on the attaching bolt. The spacer must be glued into the cockpit.

It is mandatory for boats that the shoulder harness straps should be mounted to a metal channel spanning the backboard securely fastened to the sides of the centre section of the boat as shown in 509.18.

For classes where reinforced cockpits are required, boats will have to be provided with reinforced cockpit having the following minimal measures.

It is taken into account the need to leave around the body the volume necessary to absorb some slight deformation without remaining trapped into the cockpit:

- The height between the base and the roof of the cockpit for the race boat furnished with closed cockpit and seat shall be such that the minimum helmet clearance of 509.05 is maintained. The driver shall not be reclined more than 45° from the vertical.

- ALL the following dimensions are MINIMUM.

- The width at feet level, up to two pedals = 28cm

- The width at feet level, with three pedals = 36cm

- The width at knee level = 40cm

- The width at hip level = 43cm

- The vertical internal dimension at foot level = 33cm

- The vertical internal height at knee level = 42cm

- The length of the opening in cockpits, boats built after 1st January 2006 = 54cm and width of 43cm

- The width at shoulder level, not less than 56cms from the lower point of the cockpit = 48cm.

A canopy must be fitted to the reinforced cockpit, closed and latched at all times while engaged in practice or racing.

#### 509.04

A jacket with ballistic covering having approximately 4.5 kg (10 lbs) flotation and equipped with epaulette type extraction loops on the shoulders and properly fitted to prevent being accidentally pulled over the head is mandatory. In classes with mandatory safety cockpit no colour requirements.

Flotation overalls are a permitted alternative to life jackets, but must conform to all life jacket requirements (buoyancy, protective plates, collar, etc.). The overalls must also include the cut resistant material required in rule 205.11.

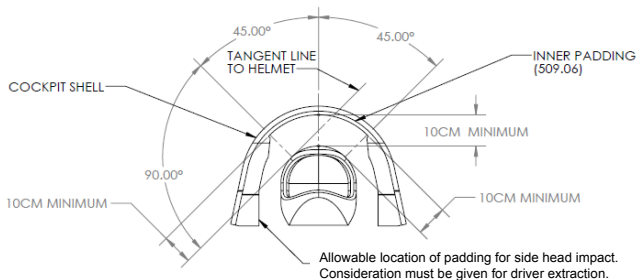
#### 509.05

All reinforced cockpits are required to be designed so that the driver is completely enclosed including the driver's head.

All cockpits require a minimum 10 cm (4 in) clearance above the driver's helmet, covering at least 50 % of the top of the helmet and at least 50 % of the side of the helmet with the driver's head in the furthest aft position, as an integral part of the cockpit construction. This clearance must include clearance to any canopy hinges or latching mechanism.

As regards the lateral extension of the head clearance the cockpit must afford a minimum of 10 cm (4in) clearance above the driver's helmet and extending laterally at least 45° from the vertical. (See Figure 1).

This min 45° lateral extension is mandatory for boats built after January 1<sup>st</sup>, 2016 and recommended for boats built before 2016



**FIGURE 1**

For reinforced cockpits where the lateral extension of the cockpit covers at least 50% of the side of the helmet, the canopy is not required to be load bearing. However, the canopy must not be able to deform under load in such a way that it becomes "stuck" under the supporting flanges of the cockpit. For cockpits not meeting this side of the helmet coverage an integral load bearing canopy is required.

For integral load bearing canopies the canopy structures will provide the helmet coverage. The integral load bearing canopy structure will be at least as strong as the reinforced cockpit structure and provide a load path to transmit loading into the cockpit structure. That is, the canopy must be latched and hinged in such a way that it remains in place and is supported so that it acts as though it was part of the cockpit structure during an accident. Inboard hydroplanes that require reinforced cockpits, including R1000 and up to R<sup>∞</sup> and including GP Hydro (903 rules) may have cockpit escape hatches in the bottom of the cockpit.

#### **509.06**

Foam support completely around the inside of the helmet area consisting of a minimum 12 mm (1/2 in.) 4 kg (9 lbs.) Ethafoam or other energy absorbing material to prevent injury from helmet hitting cockpit is required. Clearance between the helmet and the foam must comply with 509.05.

#### **509.07**

The top of the front of the cockpit will be a maximum of 10 cm (4 inch) below eye level, and so constructed as to deflect water away from the driver.

A rounded deflector should be incorporated at the rear of the reinforced cockpit. The deflector should be manufactured from the same composite material and layup schedule as the reinforced cockpit, and should have a minimum thickness of 1/2". The deflector should cover the vertical area between the top of the cockpit and a horizontal line between the deck tops. The area in the boat interior below the deck surfaces may be left open. Solid foam should fill the volume between the deflector and the rear of the driver compartment. Additionally the reinforced cockpit structure should extend rearward from the driver compartment as far as possible.

Alternately, cockpits conforming to the F1 rules are allowed.

Implementation for F2, RD unlimited (904 rules) and Grand Prix Hydro (903 rules).

**509.08**

Energy absorbing foam padding is to be strategically placed inside the cockpit -limiting side-to-side head movement and areas where the knees, hands, etc., might impact.

Seats are mandatory for all cockpit classes.

**OBJECTIVE OF SEAT**

Work with the restraint belts connecting driver's body securely to the cockpit, thus creating minimal movement between the cockpit and body.

Spreading of load over the body, reducing the chance of local loading and injury.

**SEAT**

Construction to be stiff and strong enough so that attachment to cockpit is secure and movement between any part of the seat and cockpit is minimal (less than 10 mm) in crash loading.

Closely fitted to the rear and side of each driver's shoulders, ribcage, pelvis and thighs (to at least midway from hips to knees).

Minimal padding that is sufficient for driver comfort while racing (typically 10 mm).

**MANDATORY AFTER JANUARY 1, 2019**

Flat panels beside the legs, to reduce possible injury.

No exposed hardware, inside cockpit, which would come in contact with the driver, in a crash.

**509.09**

No sharp edges or protrusions anywhere inside or around the entryway of cockpit.

**509.10**

A removable steering wheel is mandatory.

The steering wheel must be easily removable without tools.

**509.11**

Left and right rear-view mirrors are mandatory.

**509.12 - MOTOR SHUT OFF SWITCH**

All boats with reinforced cockpits will have an ignition shut-off switch and fuel shut-off switch or lanyard to a killswitch in the cockpit for the motor, located on the left (port) outside of the cockpit. It will be clearly marked "MOTOR SHUT OFF SWITCH". Kill switch lanyard connections are not required on boats with reinforced cockpits.

Lanyard connection to the life vest is required to shut off the fuel on boats with electric fuel pumps.

**509.13 - VISIBILITY IN COCKPITS**

For boats built after 1st January 2006, the driver must have, when strapped in his cockpit, a horizontal field of view of at least 180 degrees.



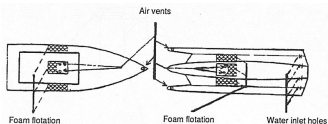
**509.14**

Air vents must be provided in the sponsons or into cockpit of all catamarans : 2x20 cm<sup>2</sup> (3in<sup>2</sup>).

For catamaran boats these air vents cannot be behind the driving position.

These air vents can be behind the driving position of V nosed boats and in the bow.

Airtight compartments in the aft end of racing boats are prohibited.

**RECOMMENDED FOAM FLOTATION (see § 504.01) AND AIR VENTS LOCATION****509.15**

Water inlet holes on catamarans as shown in the sketch must be in the rear of the centre section fore and aft sides.

These holes must be at least 40 sq. cm (6 sq. in) in an area each side and communicate with air space inside the sponson. Any communicating holes in intervening bulkheads must be the same size. Air/water must be able to pass freely from these holes to air vents in the upper front of the sponson/boat.

**509.16**

All windscreens will be shatterproof material. All reinforced cockpit canopies shall have an external handle or hand hold opening to facilitate the opening of the canopy.

The following requirements are specified for reinforced cockpit canopies (For F1, mandatory for new construction after January 1, 2005. For S3000, F2 (S2000), mandatory for new construction after January 1, 2006):

1. Canopy windscreen/window material and shapes shall be a minimum of (8 mm) polycarbonate material of high optical grade with scratch resistant outer coating. Such canopy shapes, forms, and materials are available, for example, from Formtech Plastics Inc., USA +1 800 860 7572. For F1 all the rules in 509.16 apply regardless when cockpit was built. It is also possible to use automotive safety glass with proper testing reports given to the UIM for the canopy as long as it is stronger than the 8 mm polycarbonate.
2. All canopy support inner and outer frames, "U" and "H" channels, shall be constructed of a minimum of 2000 grams of "S" glass and/or Kevlar and bonded utilizing epoxy resin.
3. If the polycarbonate canopy frames are not glued, the frames shall be affixed thru-bolted utilizing bobbins/sleeves made of nylon, delrin, aluminium, or other material so as to not directly cause clamping forces to the polycarbonate material by thru-bolts. Bolt spacing shall be no greater than every 5 cm and shall incorporate the use of 6 mm diameter (minimum) stainless steel bolts. All bolts shall utilize stainless steel nylock or acorn nuts with washers. No bolt threads or sharp edges shall endanger the driver in the interior of the cockpit.
4. All canopy hatches, lids, and caps shall be constructed of a minimum of 12 mm foam or balsa core material of 3 kg density laminated with 2000 grams of "S" glass and/or Kevlar bonded with epoxy resin.
5. All outer edges of canopies and hatches shall be protected from water intrusion leading to possible failure by the use of water deflectors, frames, or channels.
6. All canopy or hatch openings which allow access to the cockpit or driver shall include provision for a slot and pry bar pad to be utilized by rescue in the event of jamming or failure.
7. All canopy structures, hardware hinges, mechanisms, construction techniques and installation methods are subject to approval by the cockpit commission.
8. In all cockpit classes it is allowed to use an integrated canopy structure.

It should comply with UIM rules regarding UIM safety cells under the condition that the manufacturer certifies in regard to the canopy:

The sufficient strength of the construction, and at a minimum, the equal strength and integrity to existing cockpit/canopy systems. That the canopy has passed all tests in this rulebook.

9. All hinges attached to a reinforced cockpit canopy must have pins easily pulled out, and utilise pull rings or knobs, accessible both externally (for diver) and by the driver below the closed canopy.

Mandatory for F1, S3000, F2 and S2000.

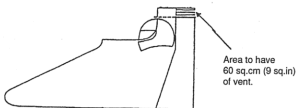
The following minimum specification is required for canopy hinges:

- a. The canopy safety hinge shall be manufactured of stainless steel.
  - b. The minimum length of the hinge shall be 10 cm overall.
  - c. The minimum width of the hinge shall be 3 cm.
  - d. The minimum thickness at the mounting surface shall be 3 mm with 3 fasteners at the end.
  - e. The pivot point shall be a fixed 6 mm diameter axle pin and shall not be a quick release point of the hinge.
  - f. A secondary quick release pin of the push/pull type with a minimum 6 mm diameter shall be incorporated in such a manner as to enable the hinge to be easily released by rescue personnel.
  - g. The secondary push/pull shall include a drive out pin feature, as well as a stainless steel pull ring.
  - h. The design of the hinge shall prevent the binding of the quick release pin in the event of an incident requiring its removal.
10. Canopy latches or closers must be designed to keep the canopy closed during an accident.

### 509.17

It is recommended that in a reinforced cockpit there is an opening of 60 sq. cm (9 sq. in) above the helmet so as to reduce the hydraulic effect on the driver in case of an accident.

For old and new cockpits the reinforced cockpit backboard behind the driver shall be at a minimum the same strength as the sides of the reinforced cockpit. The lay-up schedule and bonding mechanism shall be defined in the reinforced cockpit registration questionnaire.

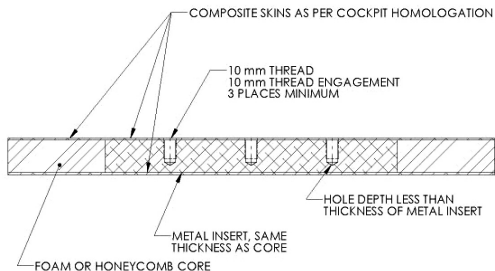


### 509.18

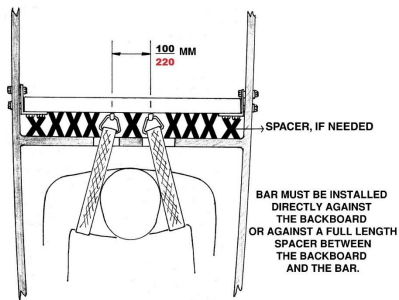
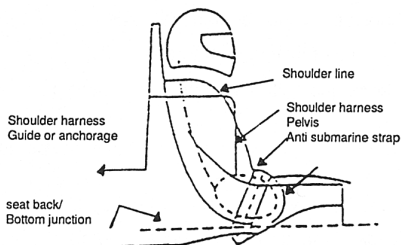
These are the mandatory requirements for the placing of seat belts and shoulder harness to be used in a reinforced cockpit: Any substitution system must be approved by Safety Cockpit Committee.

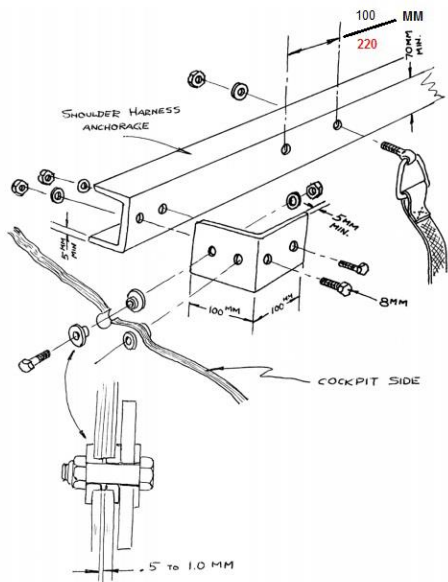
The crotch strap must be anchored to the capsule bottom with bolts in accordance with rule 509.03 and the anti-submarine belt mounting drawing that is part of this rule 509.18. As an alternative the crotch strap may pass through a structure of 1.5x equivalent strength on the bottom of the cockpit just in front of the seat to prevent sliding forward or upward.

## ALTERNATIVE CROTCH STRAP ANCHOR

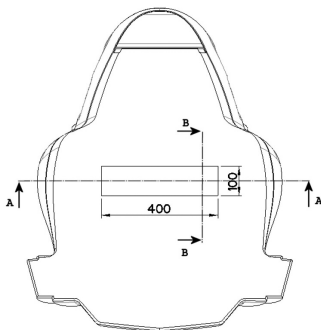


Shoulder harness should be installed 90° to spine at shoulder line to minimize compression injuries under high "G" loading.

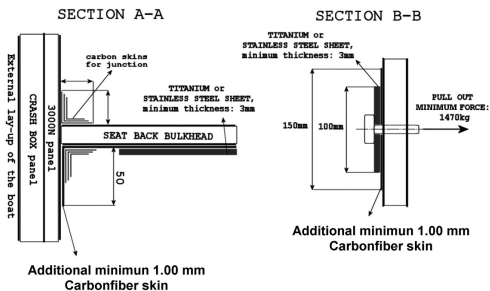




## ALTERNATIVE SHOULDER HARNESS ANCHORAGE

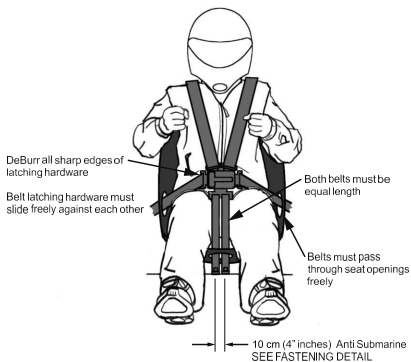


BACK VIEW OF THE SEAT-BACK BULKHEAD

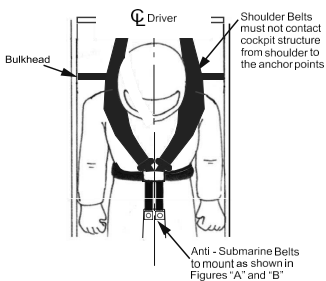


Seat Back

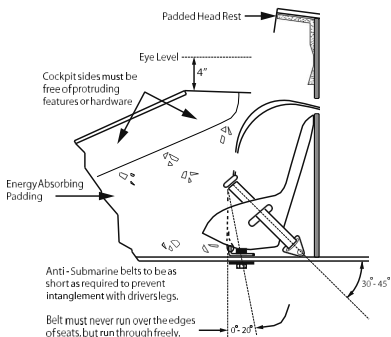
**Figure "A"**  
**Anti - Submarine Belt**



**Figure**  
**Anti-Submarine Belt**

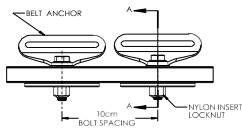
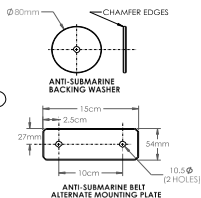
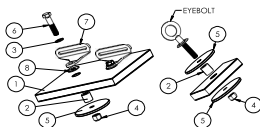


**Figure "C"**  
**Anti - Submarine Belt**

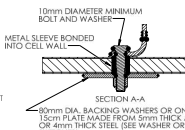


#### FASTENING DETAILS

ITEM NO.	DESCRIPTION	QTY.
1	CELL WALL	1
2	SLEEVE	2
3	FLAT WASHER	2
4	LOCK NUT	2
5	80mm WASHER	2
6	10mm DIAMETER BOLT	2
7	BELT ANCHOR	2
8	LARGE DIAMETER WASHER	2



**ANTI-SUBMARINE BELT MOUNTING**



NOTE: THIS SECTION IS TYPICAL OF ALL HARNES ANCHORING TYPES THAT WOULD PENETRATE THE COCKPIT COMPOSITE STRUCTURE

## 509.19

To assist rescue crews, cockpit boats must have the bottom of that part of the cockpit containing the driver or all materials covering the bottom of the cockpit painted international orange and labelled in the centre with 30 cm (12 in) letters for the boat number, and 10 cm (4 inch) letters specifying other critical information such as: breathing apparatus (BrA). With breathing apparatus means only breathing equipment that automatically serve an unconscious driver with breathing air. Not the "spare air" type that must be handled by the submerged driver.

## GUIDELINES FOR INSPECTION OF REINFORCED COCKPITS.

- Check manufacturers ID plate and registration number.
- Check buoyancy behind bulkhead.
- Check seatbelts for wear, attachment points and release systems. (Check for corrosion, lack of maintenance, lubricated release system etc.)
- Check removable steering wheel systems. (Lack of maintenance, lubrication etc.)
- Have the driver to put on all safety equipment and get into the cockpit. Fasten all seatbelts, put steering wheel on, cover drivers visor and check to see that the driver can release him/herself.
- Check that the driver fits inside the cockpit as described in §509.05.
- Check water deflector as in §509.07 on cockpit top front.
- Check for sharp edges and energy absorbing foam inside cockpit.
- Check left and right rear view mirrors.
- Check air vents. As in §509.14
- Check water inlet holes in back of boat centre section
- Check bottom of cockpit for orange colour and boat number.
- Check function and position of MOTOR SHUT OFF SWITCH.

These guidelines are only as a help to the scrutineers of reinforced cockpits.

## 509.20 - AIR SUPPLY

It is mandatory in all classes where the competitor or crew are restrained to have a suitable air supply system available to them and each member on-board.

There should be one individual air supply (not oxygen) bottle & air regulator /mouthpiece for each crew member on board.

Each air supply bottle should have a minimum capacity of 400 liters of free air.  
(For example, this 400L may be contained in a 2L bottle at 200 bar or a 4L bottle at 100 bar)

Spare Air devices or air supply bottles that are less than 2litrs in capacity cannot be used except as a back- up to the main air system.

Each air supply bottle, regardless of size, shall be designed for the delivery of breathing air. The tank shall be stamped to verify inspection and certification of the tank to meet air delivery standards. The air tank shall be securely mounted to the boat.

The air supply bottle must be securely fastened to the boat and switched on during all on-water activity.

Each air supply bottle must have a pressure gauge for easy reading during pre-race scrutineering and by crew members on-board. **Each bottle shall also have an excess flow (safety) valve (EFV) fitted.**

Each air supply bottle must contain at least 400 litres of free air in order to pass pre-race scrutineering.

The air supply hose from the tank to the driver's mask/mouthpiece hose connection shall be of sufficient length to allow the driver to stand up in the cockpit without either pulling tight or disconnecting.

The air regulators / mouthpiece for each crew member must be easily accessible for each individual on-board. Air regulators / mouthpiece must operate in any position i.e. upside down. Alternatively, a driver's mask may be used and must cover the driver's nose and mouth and be designed to be watertight. The mask must be attached in such a way as to prevent its being dislodged or removed inadvertently. An ambient air valve is required. A quick release pressure sealing coupler shall be used to connect the air supply hose from the tank (first stage regulator) to the driver mask hose (second stage regulator); the driver mask hose length shall be 25 cm (min) to 91 cm (max) to the connection; The mask shall be worn by the driver anytime the boat is under racing or testing conditions.



A female coupler fitting shall be attached to the air supply hose from the tank; the male coupler fitting shall be attached to the driver mask/mouthpiece hose. A tee block with two male coupler fittings, attached to the driver mask/mouthpiece hose, is allowed. Parker part number SH1-62 / SH1-63 (or other manufacturer interchange) is the accepted design sealed coupler assembly; stainless steel material is highly recommended, brass is an acceptable alternative.

Each crew member in full race attire & race position must physically demonstrate to the scrutineer that they are able to locate and use their Air Supply Equipment.

Competitors & crew members are responsible at all times for maintaining their equipment and ensuring that it complies with the rules.

### **509.21 – CRASH BOXES**

Crash boxes may be constructed such as to have comparable energy absorption and energy absorption rate as the baseline constructs described by Isatec drawings and instructions. The baseline information is available from UIM.

The crash box layout drawings, strength calculations and appropriate testing data for new design shall be submitted for review and registration similar to the cockpit registration process.

The review will also consist of a drop test(s) to verify the energy absorption characteristics. The boatbuilders have to provide 3 samples (box of 33.0 cm x 33.0 cm) for testing.

For the detailed procedure for submitting the samples for testing, refer to the "crash box procedure letter" on the UIM website under the Official Forms and Procedures tab : Crash Box. Price and testing facility are listed there.

The construction must be done by a 3000 N registered cockpit builder. Verification of construction may be accomplished by core sample or approved non-destructive testing.

### **509.22 - REPAIRS**

1. Any damage on the Crash-box must be repaired by a UIM registered Crash box manufacturer only; and any new installation of a registered Crash box or cockpit, or cockpit repair must be done by a UIM registered Cockpit or Crash box manufacturer only; who must send to the UIM and NA pictures of the sequential steps of repairs and a signed letter certifying the repair has been correctly done.

2. For any other damage on structural areas of the boat, the repair must be certified in writing as the best state of the art from the company/person in charge of repairing the boat and delivering pictures of the sequential steps of repair to the UIM and NA.

3. Copy of the above documentation (1.-2.) must be shown to the UIM Technical Commissioner at first race after repair. The acceptance is based only on Manufacturer/Company declaration.

4. These documents will be inserted into the boat's measurement certificate in the digital log book where available, otherwise attached to the paper measurement certificate.

### **509.23 - HULL IDENTIFICATION NUMBER (HIN)**

Every safety cockpit and hull needs a permanent HIN label glued or engraved in the structure of safety cockpit in a visible place.

### **509.24 - GUIDELINES FOR INSPECTION AIRBAG SYSTEM**

- Check manufacturers ID plate and registration number.
- Check condition and date balloon
- . Check vertical trigger with system control
- . Check Battery electronic unit control and timer
- . Check opening rear plate
- . Check condition air tube

## **510 - RACING INBOARDS (R)**

### **511 - CLASSES**

R 1000	cylinder capacity of the motor up to 1000 cc incl.
R 1500	cylinder capacity of the motor from 1001 to 1500 cc incl.
R 2000	cylinder capacity of the motor from 1501 to 2000 cc incl.
R 2500	cylinder capacity of the motor from 2001 to 2500 cc incl.
R 5000	cylinder capacity of the motor from 2501 to 5000 cc incl.
R 7000	cylinder capacity of the motor from 5001 to 7000 cc incl.
R ∞	cylinder capacity of the motor from 7001 to infinity

### **512 - HULL**

#### **512.01**

The hull design is free.

#### **512.02**

Any device to produce a sudden braking effect, causing excessive water spray reducing visibility, is forbidden.

#### **512.03 - MINIMUM DIMENSIONS**

Class	Weight	Length	Reinforced cockpit
R 1000	300 kg	4.20 m	mandatory
R 1500	350 kg	4.50 m	mandatory
R 2000	390 kg	4.80 m	mandatory
R 2500	420 kg	5.10 m	mandatory
R 5000	600 kg	5.70 m	mandatory
R 7000	700 kg	6.10 m	mandatory
R ∞	800 kg	7.00 m	mandatory

- 1) The minimum weights mentioned above are the weight of a complete rig weighed directly after the race without driver, or residual water but including the residual fuel.
- 2) Measurements are taken while the boat is ashore.

The length must be measured as the overall length of the hull between perpendiculars at the foremost and aft most rigid part of the hull.

Any extending parts, rubbing stanches, fenders, stablishing and trim tabs and rudder are not to be included.

### **513 - MACHINERY**

#### **513.01**

The motor is free.

The motor must be fixed inside the hull.

The power transmission train must pass through the structure of the hull.

All modifications are allowed.

### **513.02**

Only one propulsion device is allowed and the total effort must be applied to the water.

### **513.03**

When the propulsion is of the water jet type, the jet may be ejected in the air.

### **513.04**

An electric starter and battery must be on board.

### **513.05**

The transmission is free.

## **514 - FUEL**

See 508.01, 508.03, 508.06, 508.07, 508.08, 508.09, 508.10, 508.11

## **515 - RACING INBOARD - HISTORIC (H.R.) - FORMULA R 1000**

### **516 - CLASSES**

Formula R 1000 cylinder capacity of the motor up to 1000 cc incl. (for old Wartburg engines max capacity is 1020 cc).

Minimum weight hull only 200 kg. After January 1, 2019 minimum weight hull only 250 kg.

Minimum weight with driver 280 kg. After January 1, 2019 minimum weight with driver 330 kg.

HR 2000 Cylinder capacity from 1001 cc. to 2000 cc. included.

Reinforced Cockpits are required for the HR 2000.

For class Formula R 1000 (also FR 1000, HR 1000) it is mandatory that boats built after January 1, 2019 must have reinforced cockpits complying with the standards of rule 509 (to a level of 3000 N), 509.01, through 509 end. For boats without reinforced cockpits built before January 1, 2019, a reinforced cockpit complying with the standards of rule 509 (to a level of 3000 N), 509.01 through 509 end must be installed.

For boats with cockpits built according to Rule 509.01 to 509 end already installed into the hull meeting the 2000 N standard and built before January 1, 2019; the owner must confirm with documents from the original cockpit builder that the cockpit conforms to the construction standard of the original 2000 N composite layup and construction standards.

This document shall be attached to the boat's measurement certificate as well as the documents in the digital log book when it becomes available. After January 1, 2020, the document must confirm that the cockpit and hull installation complies with the 2000 N standard . It is not permitted to retrofit after January 1, 2020, an existing 2000 N cockpit into a different existing hull.

For boats with cockpits already installed into the hull meeting the 2000 N or 3000 N standard built before or after January 1, 2019; the owner must have the boat inspected by a measurer listed on the "LIST OF UIM INTERNATIONAL MEASURERS FOR CIRCUIT BOATS WITH REINFORCED COCKPIT" on the UIM website.

This inspection will confirm the proper installation of the restraint system, seat and other features included on the "Circuit boat with reinforced cockpit measurement sheet" available on the UIM website. The completed form will also be attached to the boat's measurement certificate and the digital log book when it becomes available.

After January 1, 2025, it is mandatory that all boats for class Formula R 1000 (also FR 1000, HR 1000) must have reinforced cockpits complying with the standards of rule 509 (to a level of 3000N), 509.01 through 509 end.

## **517 – HULL**

### **517.01**

The hull must be of a hydro type (the sponson should not exceed 60% of the total length of the hull).

Pickle forks: as per 509.02.

Mirrors are mandatory.

It is not permitted to drive with a closed hood or lid over the driver's head except for boats with registered cockpits that fully comply with all the 509 Rules.

### **517.02**

Any device to produce a sudden braking effect, causing excessive water spray reducing visibility, is forbidden.

## **518 - MACHINERY**

### **518.01**

Only naturally aspirated, reciprocating, carburetted boat, motorcycle or motor car engines, of a model and type manufactured at least ten years ago, are permitted.

Also engines which are originally manufactured with fuel injection are allowed provided they are re-worked to use carburetors only.

It will be the responsibility of the driver to prove the eligibility of the engine.

The drive line between engine and propeller to be basically straight (no Z drives). A gearbox may be attached at the motor however it is forbidden to change the gears while racing.

### **518.02**

For HR 2000 cc. only automobile motors built before 1987 are allowed.

## **519 - FUEL**

See 508.01, 508.03, 508.06, 508.07, 508.08, 508.09, 508.10, 508.11.

## **520 - RACING OUTBOARDS (F & O)**

### **521 - CLASSES**

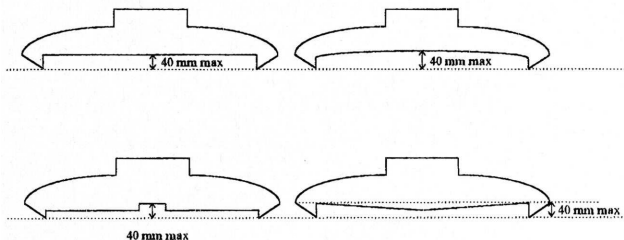
- F 125 cylinder capacity up to 128 ccs.
- F 175 cylinder capacity up to 175 ccs incl.
- F 250 cylinder capacity up to 250 ccs incl.
- F 350 cylinder capacity up to 350 ccs incl.
- F 500 cylinder capacity up to 500 ccs incl.
- F 700 cylinder capacity up to 700 ccs incl.
- O 850 cylinder capacity from 701 up to 850 ccs incl.
- O 1000 cylinder capacity of the motor from 851 up to 1000 cc incl.
- O 1500 cylinder capacity of the motor from 1001 up to 1500 cc incl.
- O 2000 cylinder capacity of the motor from 1501 up to 2000 cc incl.
- O 3000 cylinder capacity of the motor from 2001 up to 3000 cc incl.
- O  $\infty$  cylinder capacity of the motor from 3001 cc to infinity.

## **522 - HULL**

### **522.01**

For F125, F175, F250 and F350 the hull must be only of Hydroplane type with a maximum sponson length of 60 % of the total length of the hull.

Any longitudinal air entrapment structures on either side of the hull behind the sponsons must be less than 40 mm deep at the transom. They must not extend beyond a straight line drawn from the rear lower point of the transom and the point 40 mm below the bottom of the transom (measured from a straight line across the boat at the transom as shown on the sketches).



For the classes F500 and F700, hull type **must be a catamaran type, based on twin hulls, but may be of completely free hydrodynamic and aerodynamic design.**

For the classes O850 to O  $\infty$ , the hull design is free.

## 522.02

All hydroplane hulls in classes F125, F175, F250, F350, OSY 400 must have reinforced side protection as shown in the sketches.

All dimensions are minimum unless stated. Measurements taken from inside of hull from solid floor on which the driver lays or kneels (no cushions). Reduction to the front side panel is permitted for vision or to have vision panel installed.

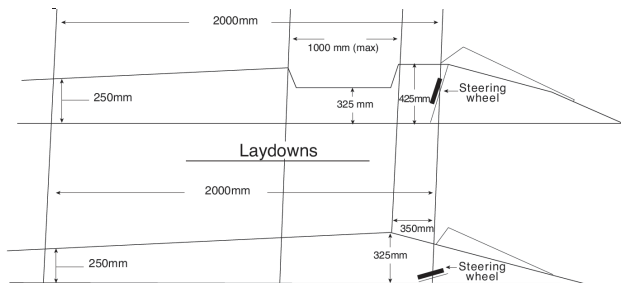
On kneelers the amount of cut out to keep stabilisation is as per drawings and no reduction at front.

Cockpit coaming sides shall be made of wood/Kevlar, wood/Kevlar/carbon, or alternatively, carbon/Kevlar/foam core/glass composition. The Kevlar composition layers add up to a minimum of 340 gm. (10 oz.). The Kevlar (and carbon, if used) shall be sandwiched between two or more layers of marine plywood and provide a minimum thickness of 9 mm. All composite coaming construction shall have a minimum of 9 mm thickness. An inspection area shall be provided in the cockpit side in order to determine that the required materials have been used. It is recommended that this area be a set of concentric circles starting with an approximately 25 mm. diameter and reducing in diameter as each layer of the construction lay-up is exposed.

For retrofit of existing boats, reinforcement shall be 2 layers of a minimum of 315 g Kevlar material to total 6 mm minimum thickness. This should be bonded to clean wood, free of varnish, paint, etc. Alternatively, a panel fabricated as described in the paragraph above, meeting the dimensional requirements, may be bonded to the interior surface of the existing cockpit sides to provide reinforcement.

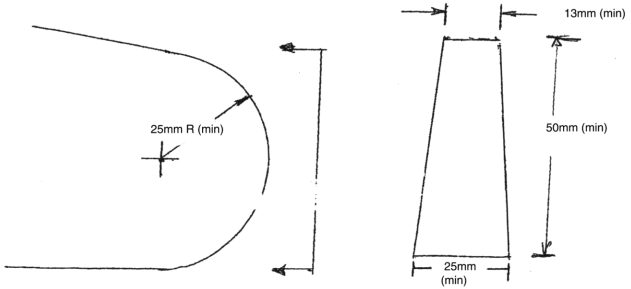
All hydroplane hulls with pickle forks must have sponson leading edges of a blunt surface that is a minimum of 25 mm radius in one direction. Minimum thicknesses are as shown in the drawing. If extensions of the pickle forks are used, it must have deformable pickle forks for a minimum length to give an exposed blunt surface when removed that is a minimum of 25 mm radius in one direction.

## KNEELERS

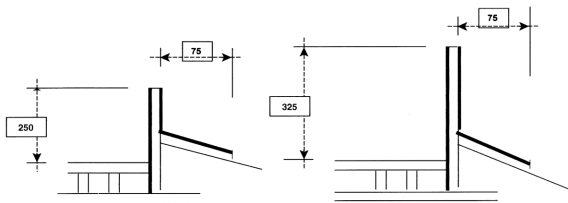


All Dimensions  
Minimum unless noted

## SPONSON TIPS

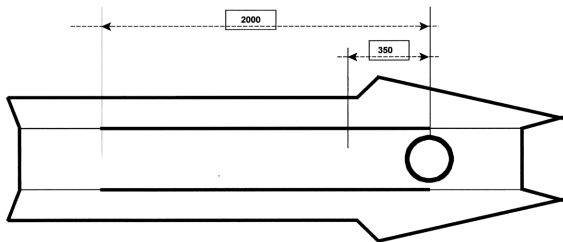
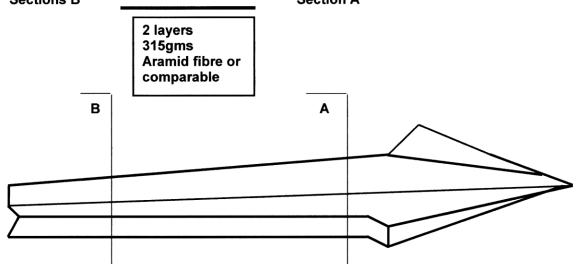


For retro-fit and a new construction alternative as specified in 522.02, fifth paragraph.



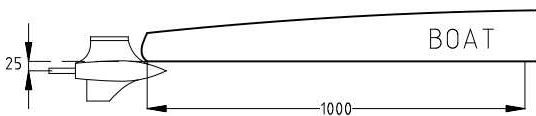
Sections B

Section A





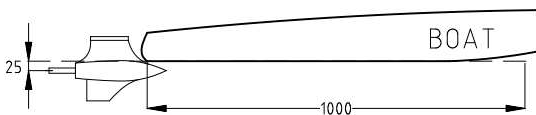
## FLAT BOTTOM



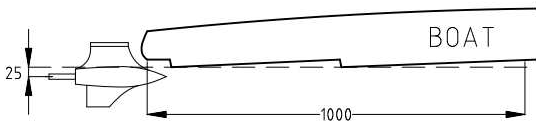
## SHORT ROCKER



## LONG ROCKER



## STEPS



HYDROPLANE PROPELLER SHAFT HEIGHT MEASUREMENTS

### 522.03 SPONSON FIN FOR HYDROPLANE TYPE BOATS

Any device, except mandatory sponson fin, to produce a sudden braking effect, causing excessive water spray, reducing visibility, is prohibited.

A fin to lean out from the keel (Sponson fin.) must be fixed by a pivot bolt with friction washers to inhibit rotation from water pressure and/or two bolts to inhibit rotation.

Alternately, a pivot bolt and one bolt to lock a rotation; in case of accident a possible knock on the fin will break the bolt in order to allow the rotation of the same fin around the pivot. The rotation of fin must be sufficient to relieve the keel totally.

Dimensioning:

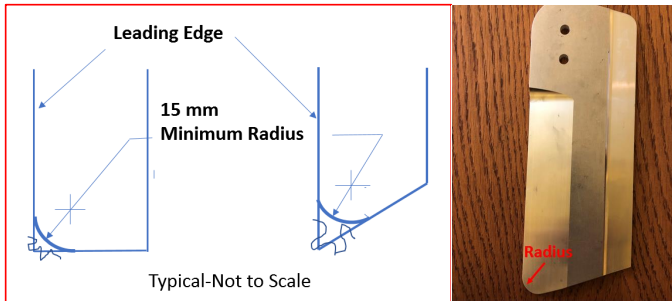
- Pivot: to be guaranteed free rotation
- Stopper bolt: screw M4 max, material inox AISI 304 UNI 6900-71
- Distance from pivot to hole of screw: max 40 mm
- One or two spring must be fitted to replace the fin in the working position when the stopper bolt has been broken in case of accident.

It is mandatory that the measurer controls the function of all components. Spring action should be demonstrated with M4 bolt removed.

For competition, the fin must be at least 140 mm long/deep measured vertically from the lowest part of the boat where it is located and have a horizontal width of at least 40 mm.

#### TURNING FIN LEADING EDGE RADIUS, O AND F CLASSES

A minimum radius dimension of 15 mm is required between the leading edge and the bottom edge of the turning fin. The radius is tangent to the leading edge. Longitudinal position for fin must be between 25-50 % from boat length measured from the nose of the hull.



## 522.04 - MINIMUM DIMENSIONS

Class	Minimum Weight with driver	Reinforced cockpit
F 125	190 kg	
F 175	190 kg	
F 250	210 kg	
F350	230 kg	until 31.12.2022
F 350	250 kg	mandatory from 01.01.2023
F 500	300 kg	mandatory
F 700	300 kg	mandatory

From 01.01.2023 in F-350, ONLY hydroplane type hulls with full UIM reinforced cockpit will be allowed.

Class	Weight	Length	Reinforced cockpit
O 850	250 kg	3.90 m	mandatory
O 1000	300 kg	4.20 m	mandatory
O 1500	350 kg	4.50 m	mandatory
O 2000	390 kg	4.80 m	mandatory
O 3000	450 kg	5.10 m	mandatory
O ∞	520 kg	5.30 m	mandatory

- 1) The minimum weights mentioned here above are the weight of a complete rig weighed directly after the race without residual water but with residual fuel.
- 2) Measurements are taken while the boat is ashore.

The length must be measured as the overall length of the hull between perpendiculars at the foremost and aftmost part of the hull including deformable pickle-forks if so designed and equipped.

Any extending parts, rubbing stanches, fenders, stabilising and trim tabs and rudder are not to be included.

## 523 - MACHINERY

### 523.01

The motor is free except Class F125 which is restricted to single cylinder only.

An outboard motor is a mechanical propulsion assembly which can be removed from the boat as a single unit, complete with its transmission, and which does not transmit the power through the hull at any point. Any mechanism intended to modify the angle of attachment and/or the height of the motor is authorised.

The motor thus taken off and placed ashore must be capable of being started, fed by its fuel tank.

The mounting supports fixed to the boat, the control levers, the tachometer with its connections, the battery with its conductors and the fuel tank and fuel lines do not form part of the power unit.

### 523.02

Only one propulsion device is allowed and the total effort must be applied to the water.

**523.03**

When the propulsion is of the water jet type, the jet may be ejected in the air.

**523.04**

The transmission is free.

**523.05**

All un encased outboard motors with capacitor discharged ignition shall have a flywheel guard.

**523.06**

For competition with these F class hydroplanes there is a minimum depth of the center-point of the aft end of the propeller shaft according to the following chart. The reference for these measurements is a plane created by the points of maximum depth of all running surfaces and air traps of the boat bottom for the last 100 cm of the boat from the furthest aft parts forward. The measurement is taken with the engine lift in the maximum up position.

CLASS	MINIMUM DEPTH PROP SHAFT
O-125	0 mm
O-175	0 mm
O-250	35 mm
O-350	35 mm

The power trim is not allowed for F-125, F-175, F-250 and F-350.

**524 - FUEL**

See 508.05, 508.06.

Four stroke "F" and "O" class engines only: see 508.01 - 508.02 - 508.06 - 508.08 - 508.09 - 508.10 508.11

**525 - CLASS OSY 400****525.1 - HULL****525.1.01**

The hull must be of a hydro type (the sponson must not exceed 60 % of the total length of the hull).

Minimum weight with driver 190 kg.

Sponson fin must confirm with rule 522.03.

**525.1.02**

A reserve of visible and sufficient flotation must be provided to keep the hull floating in case of accident (see § 504.01).

**525.1.03**

Any device to produce a sudden braking effect, causing excessive water spray, reducing visibility, is prohibited.

## 525.2 - MACHINERY

Any machinery aimed at modifying the motor attachment angle and/or the height of the motor while the motor is running is forbidden.

### 525.2.01

The outboard must be a Yamato model of Series 100, 200 or 300, as duly homologated by the UIM.

### 525.2.02 - SOLE MODIFICATIONS ALLOWED

- 1) It is permissible to use any ignition wire, spark plugs, propeller nut.
- 2) It is permissible to drill water drain holes in the ignition castings (coil plates and crankcase end cap) and these holes may be tapped and plugged.
- 3) It is permissible to use any fuel line or fittings providing threads in tank and carburettor are not changed. A fuel filter may also be used.
- 4) It is permissible to enlarge the gas tank by cutting it apart at the seam and adding at least 2" band (2" will give one third of a gallon more) or may build a complete tank, but it must be mounted the same as the original. The tank mount plate may not be modified.
- 5) A fuel pipe may be used for marathon racing but the hole in the crankcase must be plugged when racing same motor in closed course.
- 6) Bolt threads may be repaired by tapping oversize or use of helicoils.
- 7) Broken parts may be repaired by welding or use of plastic compound, if all contours remain the same. In addition to that, in the area of the crank shaft journals, where the crank shaft assembly is bedded a repair is permissible according to the following procedure. The crankshaft journal must be machined in that area to a smaller diameter. A steel bushing can be pressed onto the machined crankshaft journal. This steel bushing must have exactly the same contour as the material which is replaced by the bushing (outer diameter, length). This repair assumes, that no changes to the weight and to the contour of the crankshaft assembly can be made.
- 8) Any water flow restrictions are permitted.
- 9) No polishing or removal of metal on any internal passages or carburettor, intake manifold, or tuned exhaust system.
- 10) No polishing or balancing of reciprocating or rotating parts.
- 11) Any type of thrust bracket adjustment is allowed providing no alterations are made to the motor and may not be adjustable while boat is moving.
- 12) The tilt lock lever may be removed and the spacer on the tilt bracket bolt.
- 13) The holes in steering bar may be drilled larger for attaching steering cable.
- 14) Any device may be used to hold spark lever in advance position.
- 15) Spray shield may be modified to use throttle cable, and for choking carburettor. Where a hole is in the side it must not exceed 30 mm in diameter or equivalent area.
- 16) The propeller shaft may be turned down or replaced to fit any propeller.  
The propeller is free.
- 17) The use of non-Yamato parts are forbidden.
- 18) Measurements not quoted in the homologation sheet may not be altered. If a detail cannot be verified with the aid of the pictures in the homologation sheet, the part in question can be compared to corresponding stock part. In such a comparison it is only possible approximately to use the comparable measurements as the manufacturing tolerances are not available.
- 19) The driver is responsible for the condition of the engine as raced. Errors on the part of one manufacturer,

mechanic or previous owner is no excuse.

- 20) Shorting switch is mandatory (i.e. jack plug).
- 21) Oversize pistons allowed to first over-bore only (max.bore size: 2.622 or 66.59 mm e.g. 66.50 + 0.09 mm. No blending of the ports (See Rule 525.2.02 Pt. "no removal of metal"). Any very sharp edges caused by the re-boring can be gently taken away.
- 22) Any type, size or make of nut, bolt, screw, washer may be used except for butterfly screw which must be standard.
- 23) Painting - it is permissible to paint any part of engine and accessories any colour.
- 24) Any holes can be drilled to safely attach engine to the hull.
- 25) A part from the above provisions, it is absolutely forbidden to make any alterations to the engine manufacturers standard components either by removal or addition of material. In particular this includes components being subjected to any form of machining, grinding, hand tooling, reworking, reshaping, fettling, polishing etc. unless it is specifically permitted.
- 26) Plug caps may be changed.

### 525.3 - FUEL

See 508.01, 508.02, 508.06, 508.07, 508.08, 508.09, 508.10508.11

### 525.4

For competition in OSY400 class there is a minimum depth of the center point of the aft end of the propeller shaft according to the following chart. The reference for these measurements is a plane created by the points of maximum depth of all running surfaces and air traps of the boat bottom for the last 100 cm of the boat from the furthest parts forward excluding air traps up to 7mm in width.

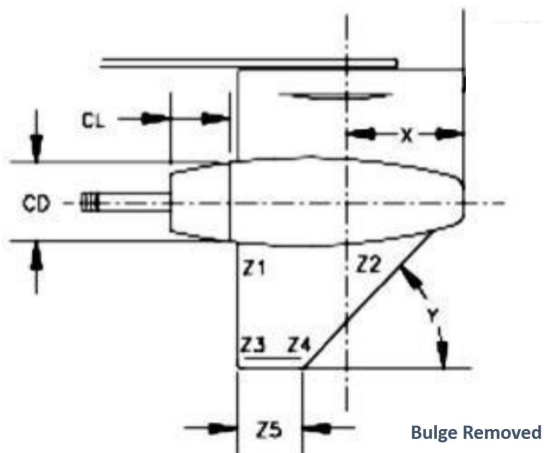
CLASS	MINIMUM DEPTH PROP SHAFTOSY-400	25 mm
-------	---------------------------------	-------

These dimensions will be checked in the "as raced" condition.

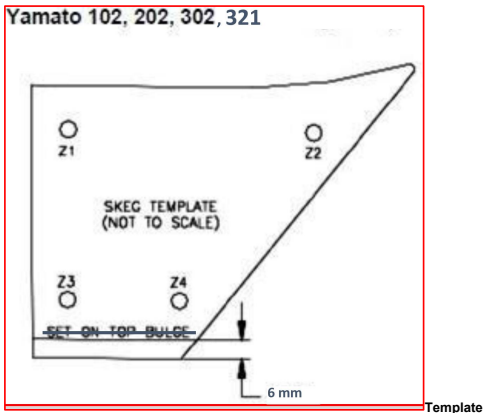
### 525.5 SKEG

From 01/01/2023, The skieg of the homologated Yamato engines for OSY 400 Class may have the leading edge sharpened and the bulge on the lower end of the skieg removed. The area and planform of the skieg along with minimum thicknesses shall be maintained per the drawing below.

## Yamato 102, 202, 302, and 321



Y	50 degrees
Z1	4.83 mm min.
Z2	4.83 mm min.
Z3	3.80 mm min.
Z4	3.80 mm min.
Z5	49.5 mm min.



## **530 - SPORT INBOARDS (E)**

### **531 - CLASSES**

- E 1000 cylinder capacity of the motor to 1000 cc incl.
- E 1500 cylinder capacity of the motor from 1001 to 1500 cc incl.
- E 2000 cylinder capacity of the motor from 1501 to 2000 cc incl.
- E 2500 cylinder capacity of the motor from 2001 to 2500 cc incl.
- E 5000 cylinder capacity of the motor from 2501 to 5000 cc incl.
- E 7000 cylinder capacity of the motor from 5001 to 7000 cc incl.
- E  $\infty$  cylinder capacity of the motor from 7001 to infinity

## **532 - HULL**

### **532.01**

The hull design is free.

### **532.02**

Any appendage intended to lift the boat by an aerodynamic effect is prohibited. Hydrofoils are not allowed.



**532.03**

Aboard inboard craft, the motors must be housed in a covered compartment or situated under the deck but adequately and efficiently ventilated.

Transmission links and all moving parts liable to cause injury or accident must be efficiently guarded.

**532.04**

Any device to produce a sudden braking effect, causing excessive water spray, reducing visibility, is prohibited.

**532.12 - MINIMUM DIMENSIONS**

Class	Weight	Length	Reinforced cockpit
E 1000	300 kg	4.20 m	mandatory
E 1500	350 kg	4.50 m	mandatory
E 2000	390 kg	4.80 m	mandatory
E 2500	420 kg	5.10 m	mandatory
E 5000	600 kg	5.70 m	mandatory
E 7000	700 kg	6.10 m	mandatory
E ∞	800 kg	7.00 m	mandatory

1. The minimum weights mentioned here above are the weight of a complete rig weighed directly after the race without driver, or residual water but with residual fuel.
2. For all series mentioned above:

Measurements are taken while the boat is ashore.

The length must be measured as the overall length of the hull between perpendiculars at the foremost and aftmost part of the hull including deformable pickle-forks.

Any extending parts, rubbing stanches, fenders, stabilising and trim tabs and rudder are not to be included.

**533 - MACHINERY****533.01**

The motor must be fixed inside the hull.

The power transmission train must pass through the structure of the hull.

**533.02**

Marine motors homologated by UIM as having been built in series, that is with all identical and interchangeable parts and fitted ready for running, with a minimum number of 30 motors produced.

**533.03**

The marine inboard motor is a mechanical assembly producing power, specially designed and manufactured for the propulsion of boats and which is catalogued and sold by an industrial firm.

**533.04**

The motor must be ready to function, and must include the following items:

- all the accessories required for the functioning and regulation of the cooling system,
- an oil cooler,
- the motor installation mounts,
- the starting device and a generator for recharging the battery.

**533.05**

The gear box and the exhaust manifold do not form a part of the motor.

**533.06**

Only one propulsion device is allowed and the total effort must be applied to the water.

**533.07**

Only automobile motors homologated by the Federation Internationale de Sport Automobile as laid out in the general list of FISA homologated cars in group N + A are allowed.

Group N: Production cars

Group A: Touring cars

**533.08**

No other automobile motors homologated by the F.I.A. are allowed for powerboating.

**533.09**

The alterations allowed by F.I.S.A are not allowed in motor boating. Only the alterations listed in Article hereunder are allowed.

**533.10 - SOLE MODIFICATIONS ALLOWED**

1. The replacement of the dynamo by an alternator is allowed provided that the securing points of the replacing accessory and its driving system remain unchanged.
2. The fitting of a transistorised ignition system is allowed, provided that no mechanical part of the motor is altered.
3. For UIM or F.I.S.A homologated motors reboring is allowed provided the total cylinder capacity does not exceed the limits that have been provided for the class in which the motor has been homologated.
4. The air filter can be taken out or altered.
5. Dynamic air intakes can be fitted to the carburettors.
6. The mechanically operated fuel pump may be exchanged with an electrically operated fuel pump, without obligation to keep the original location.
7. An oil filter and/or a radiator may be added when not provided by the manufacturer. The original(s) may be changed.
8. The carburettor(s) fitted by the manufacturer may be replaced by one or more carburettors or by a fuel injection system provided they can be fitted without altering the cylinder head.
9. The modification or replacement of the intake manifold is allowed.

10. The valve springs may be replaced by others from any origin, but without modification of the number fitted by the manufacturer and provided they can be fitted without any modification to the original brackets.
11. Pistons are free.
12. The camshaft(s) is (are) free.
13. Increasing the compression ratio by polishing the cylinder head (or using a thin gasket or the suppression of the latter) is allowed.
14. Any tuning operation such as polishing the original parts but not replacement of same, except for pistons, the springs and the cam shafts as specified above, are allowed.
15. In other words, provided it is always possible to establish indisputably the origin of a mass produced part, this component may be rectified, balanced, adjusted, its form reduced or changed by brightening, excluding any addition of material, any mechanical extension or any treatment modifying the characteristics of the molecular structure of the metal surface.

### **533.11 - ELECTRIC STARTER**

An electric starter and its battery are required on board, as well as a device for recharging the battery.

### **533.12 TRANSMISSION**

Reverse gear is compulsory. The transmission is free.

Going astern must be obtained by reversing the rotation of the transmissions which supply the propulsive effort. In waterjet propelled boats, the astern movement is obtained by diversion of the waterjet.

The control handle for reverse gear, ready for use, must be within hand reach of the driver. Astern manoeuvring of the boat must be possible by the action of reverse gear solely.

### **534 - FUEL**

See 508.01, 508.02, 508.06, 508.07, 508.08, 508.09, 508.10508.11

### **540 - SPORT OUTBOARDS (S)**

#### **541 - CLASSES**

S 175	cylinder capacity of the motor to 175 cc incl.
S 250	cylinder capacity of the motor from 176 to 250 cc incl. S
350	cylinder capacity of the motor from 251 to 350 cc incl. S
550	cylinder capacity of the motor from 351 to 550 cc incl. S
750	cylinder capacity of the motor from 551 to 750 cc incl. S
850	cylinder capacity of the motor from 751 to 870 cc incl. S
1000	cylinder capacity of the motor from 871 to 1000 cc incl.
S 1500	cylinder capacity of the motor from 1001 to 1500 cc incl.
S 2000	cylinder capacity of the motor from 1501 to 2000 cc incl.
S 3000	cylinder capacity of the motor from 2001 to 3000 cc incl.
S ∞	cylinder capacity of the motor from 3001 to infinity
F4	up to and including 60 hp as advertised
SL 90	up to and including 90 hp as advertised

### 541.01 - LOW EMISSION ENGINES

In order to compete with parity in S.2000 class, low emission engines complying with 2006 EPA regulations will be allowed 30 % greater cylinder capacity (2600 cc). In addition, the effect of any air compressor used in support of and as part of the fuel injection system, shall be ignored in determining class displacement.

In order to compete with parity in S.3000 class, low emission engines complying with 2006 EPA regulations will be allowed 30 % greater cylinder capacity (3900 cc). In addition, the effect of any air compressor used in support of and as part of the fuel injection system, shall be ignored in determining class displacement. For classes F4, SL 90 and SL 250, only UIM homologated engines are allowed and must conform to the 2006 EPA regulations.

For F4 class the Mercury 60. 15" (homologation file 00500 series) is the only UIM homologated engine allowed.

Any new engine proposed for this class must firstly be approved by Cominsport (Rule : 506.02.02 and 506.06) and after being homologated cannot be introduced into this class for any UIM Titled Championship for two years.

Only original standard voltage (12 Volt) is admitted for the start of the Engine (in respect of the rule).

The Pin Plug connection wire and cover of the ECU (Electronic control units) of the Engine is an integral part of the Engine; only original standard from manufacturer is allowed (in respect of the rules).

## **542 - HULL**

### 542.01

Only catamarans are permitted from class S 550 onwards.

### 542.02

Any appendage intended to lift the boat by aerodynamic effect is prohibited. Hydrofoils are not allowed.

### 542.03

In S2000, S3000, S infinity, SL 250 and endurance S1 + S2, the homologated delayed operation buoyancy airbag is mandatory for all boats with sponsons constructed of composites (foam construction sandwich). Airbag has to be replaced after 5 years from production date or date of installation.

### 542.05

Any device to produce a sudden braking effect, causing excessive water spray, reducing visibility, is prohibited.

### 542.12 - MINIMUM DIMENSIONS

Class	Weight	Length	Reinforced cockpit
S 550	260 kg	3.70 m	_____
S 750	280 kg	3.90 m	_____
S 850	330 kg	3.90 m	mandatory
S 1000	380 kg	4.20 m	mandatory
S 1500	430 kg	4.50 m	mandatory
S 2000	470 kg	4.80 m	mandatory
S 3000	530 kg	5.10 m	mandatory
S ∞	600 kg	5.30 m	mandatory
F4	360 kg	3.90 m	<i>mandatory</i>
SL 90	400 kg	4.60 m	mandatory
SL 250	535 kg	5.20 m	mandatory

1. The minimum weights mentioned here above are the weight of a complete rig weighed directly after the race including driver, personal safety equipment, residual fuel but without residual water.
2. Measurements are taken while the boat is ashore.

The length must be measured as the overall length of the hull between perpendiculars at the foremost and aftmost rigid part of the hull including deformable pickle-forks if so designed and equipped.

Any extending parts, rubbing stiches, fenders, stabilising and trim tabs and rudder are not to be included.

## **543 - MACHINERY**

### **543.01**

An outboard motor is a mechanical propulsion assembly which can be removed from the boat as a single unit, complete with its transmission, and which does not transmit the power through the hull at any point. Any mechanism intended to modify the angle of attachment and/or the height of the motor is authorised.

The motor thus taken off and placed ashore must be capable of being started, fed by its fuel tank.

The mounting supports fixed to the boat, the control levers, the tachometer with its connections, the battery with its conductors and the fuel tank and fuel lines do not form part of the power unit. Only single motor is permitted.

### **543.02**

To be homologated as a sports motor, an outboard motor must be sold and advertised by an industrial firm as being manufactured in standard production series (that is to say with all parts interchangeable and with identical dimensions and materials with the equivalent part in another motor of the same model.) for the propulsion of boats.

To have homologation approved the numbers verified as in 506.01 must be: up

to 1000 cc 1000 complete units

1001 cc - 2000 cc

- 500 units, 25 of which may be fitted with midsection, brackets and gearcases as in § 543.07.

2001 cc and upwards

- 250 units, 25 of which may be fitted with midsection, brackets and gearcases as in § 543.07.

### **543.03**

A sports outboard motor must be able to run at a reduced speed.

### **543.04**

When the motor is in the water, the cooling must be effected by the homologated water circulation pump.

### **543.05**

An efficient gear changing system giving forward, neutral and astern movement is compulsory for motors up to and including 1000 cc capacity. The control handle for reverse gear, ready for use, must be within easy hand-reach of the driver when he is in the normal driving position. Manoeuvring of the boat astern must be possible by selecting reverse gear.

The casing of the underwater unit (gearcase) below the anti-ventilation plate is free. All internal parts referred to on the homologation file must be maintained. Should the homologation provide for it, the exhaust will be a propeller exhaust.

**543.06**

All lower unit exhaust openings must remain standard within the homologated size.

**543.07**

For motors 1001 cc capacity and above, forward, neutral and reverse gear are not compulsory. Such fixed gear versions are not necessarily intended for sale to or be used by general non-racing public. However, they must be available as an integral part of the complete outboard motor and homologated as such. The mounting brackets, midsection including exhaust pipes and gearcase, together with any parts required to fit these, must retain the dimensions specified on the homologation form.

**543.08**

An electric or manual starter must assure a quick and easy start without external aids. It must be used as it was supplied by the manufacturer, no adjustment or alteration being allowed.

**543.09 - SOLE MODIFICATIONS ALLOWED**

1. All studs, screws, nuts, bolts and their washers are free as well as the method of locking them;
2. The original propeller may be replaced by another in accordance with 504.13.3. The trim tab may be altered or removed to accommodate a propeller;
4. The cooling must be provided by the water pump;
5. Thermostats and pressure valves of the cooling system may be removed;
6. The steering mechanism may be altered. If the original steering bar is removed or new ones are installed, any openings created must be sealed to prevent the motor from pulling in additional air;
7. The swivel bracket may be altered for the purpose of installing a power trim and/or a power lift and the dampers (shock absorbers) may be altered or removed. For F4 class the standard power trim is allowed and the power lift is not allowed.
8. The rubber mounts of the motor may be altered, removed or replaced;
9. Revolution counters, water temperature gauges, water pressure gauges and similar instruments, can be installed;
10. Revolution limiters may be removed;
11. The gear interlock device on the starter may be removed;
12. Spark plugs are free;
13. Original carburettor jets may be replaced for another size;
14. Springs may be added to the throttle lever of the carburettors;
15. Re boring is allowed, but only piston assemblies supplied by the manufacturer of the motor may be used within the cc limit of the class. When ports in cylinders are adjusted to the dimensions specified in the homologation sheet, material may only be removed in the specified opening to a depth of 10 mm, to match the shape of the original adjacent connecting passage (channel) outside the adjusted port opening.

This also applies to other openings in the motor for which the dimensions are specified in the homologation sheet; For classes using Mercury 2.5 EFI homologation sheet n° F-1/00496 (F1 engine) the use of aftermarket pistons and connecting rods is allowed, conforming to UIM homologation specification. The number of piston rings must be the same

16. A part which is dimensioned in the homologation sheet may be machined for the purpose of reaching that specific measure;
17. A part may be machined to attain the weight quoted in the homologation sheet without altering other criteria given for the part in question. It is not allowed to change the flywheel but balancing machining is allowed if the dimensions and weights provided for on the homologation sheet are respected;
18. Measurements not quoted in the homologation sheet shall only be checked by visual comparison with standard parts. As the actual manufacturing tolerances are not published, small differences between the inspected part and the reference part must be accepted;
19. The fuel connector in the lower cover may be removed and the fuel hose from the fuel tank connected directly to the fuel pump. If this is done the opening left after the connector and around the fuel hose must be sealed to prevent extra air entering inside of cover;
20. Electric fuel pumps may be added provided the fuel still runs through the original fuel system and no parts are removed or blocked off;
21. No parts may be added to the motor unless specified in this rule;
22. It is allowed to extend the starter cord of a rewind starter so that the starting handle can be reached from the cockpit.

#### **543.10- MODIFICATIONS NOT PERMITTED ON LOW EMISSION ENGINES**

1. Blueprinting of the powerhead is not permitted. To repair a damaged cylinder block, only one half of the total cylinders may be bored to the manufacturer-supplied oversize. The remaining cylinders must remain at OEM size.
2. Alteration or removal of any powerhead components is not permitted.
3. Electrical components and control system performance must remain standard

The following rules are NOT applicable to low emission engine:

543.09 Section: 5, 10, 12, 13, 16, 17 and 20.

503.04.2 Section: 3 and 2, last sentence not valid (Only adjustments to meet dimensions in the homologation sheet are allowed).

### **544 - FUEL**

See 508.01, 508.02, 508.06, 508.07, 508.08, 508.09, 508.10, 508.11

### **545 - SPORTS OUTBOARDS - HISTORIC (HS)**

#### **545.01 - CLASSES**

HS 850.

#### **545.02 - HULL**

(as per 542.12 - S850 but cockpits with minimum 1000 N).

### 545.03 - MACHINERY

Only Yamaha 70ccs allowed. With prolonged UIM homologation (homologation file n° 00435).

### 545.04 - FUEL

Commercially available.

### 545.05- RACE FORMAT

3 heats all to count each minimum 20 km.

## **550 - MONOHULL OUTBOARDS (T)**

General: The purpose is to limit this class to simple monohulls easily built by an amateur or readily available commercially, each fitted with one single homologated "stock" motor, available on standard sale.

### 550.1 - CLASSES

JT250 cylinder capacity of the motor to 265 cc incl.

T 250 cylinder capacity of the motor to 265 cc incl.

T 400 cylinder capacity of the motor from 266 cc up to 405 cc incl.

T 550 cylinder capacity of the motor from 406 cc to 550 cc incl.

T 750 cylinder capacity of the motor from 551 cc to 750 cc incl.

T 850 cylinder capacity of the motor from 751 cc to 870 cc incl.

GT15 up to and including 15 hp as advertised

GT30 up to and including 30 hp as advertised

GT60 up to and including 60 hp as advertised

GT90 up to and including 90 hp as advertised

### 550.2 - HULL

Only monohull form is permitted. There shall be no additions or appendages to the hull that produce or contribute to aerodynamic lift.

From 2022 the deck must be able to bear the weight of a standing person (750 N) at any point.

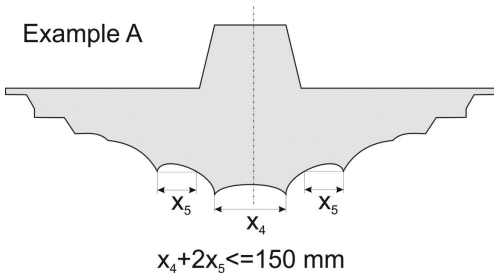
Transverse steps, tunnels, hydrofoils or devices which tend to add to the air pressure under the hull, are prohibited, except that protruding strips substantially parallel to the fore and aft line of the keel are permitted providing that in any channels, etc. so produced the horizontal measurements, of such openings with the boat on an even keel, do not add up to a total of more than 15 cm in any transverse section. Any divergence of such strips from a line parallel to the keel must show a minimum radius of 30 cm. If stopped short of the transom, strips must be tapered off to zero over a minimum length, viewed at 90 to the line of the keel and parallel to the surface of the hull in that area, of 15 cm. A single fixed vertical fin on the underwater body is allowed for directional stability.



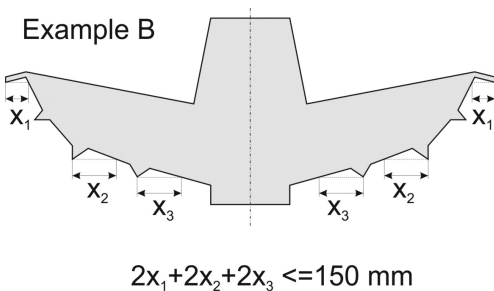
The maximum length of the fin is 250 mm.

Ballasting is allowed inside the hull but liquid ballasting is not permitted to be pumped in from the sea or pumped overboard during race or time trials.

Example A



Example B



### 550.3

Full seats must be fitted in JT250, GT15, GT30, GT60, T550, T750 & T850 classes.

"Full" means a complete seat including back support up to shoulder blades.

Construction to be stiff and strong enough so that its attachment to the hull is fully secured.

### 550.4

Any device to produce a sudden braking effect, causing excessive water spray, reducing visibility, is prohibited.

## 550.5 - MINIMUM DIMENSIONS

Class	Weight	Length	Width	Boat depth
GT15	<b>225</b> kg	3.10 m	1.35 m	0.35 m
GT30	<b>265</b> kg	3.50 m	1.35 m	0.40 m
GT60*	350 kg	4.00 m	1.40 m	0.40 m
GT90*	425 kg	4.50 m	1.50 m	0.40 m
JT250	160 kg	3.10 m	1.25 m	0.35 m
T 250	180 kg	3.10 m	1.25 m	0.35 m
T 400	240 kg	3.50 m	1.30 m	0.35 m
T 550	265 kg	3.75 m	1.30 m	0.40 m
T 750	270 kg	4.00 m	1.35 m	0.40 m
T 850 boat only	250 kg	4.25 m	1.40 m	0.40 m
T850 boat+driver	330 kg			

\* plus powertrim as manufactured

- The minimum weights mentioned here above are the weight of a complete rig weighed directly after the race including driver, personal safety equipment, residual fuel but without residual water
- Measurements are taken while the boat is ashore.  
The length must be measured as the overall length of the hull between perpendiculars at the foremost and aftmost rigid part of the hull.  
Any extending parts, rubbing stanches, fenders, stabilising and trim tabs and rudder are not to be included.  
The width of the boat is measured at the widest part of the hull.
- From 2023, the GT15 and GT 30 cockpits shall also have structural means to provide head/helmet protection such as a roll bar framework or "halo" design. The protective structure shall not inhibit driver egress from the boat. The guidelines for this construction by a boat builder will be developed, posted on the UIM website, and transmitted to National Authorities during the 2022 season.**

## 550.6 - MACHINERY

### 550.6.01

An outboard motor is a mechanical propulsion assembly which can be removed from the boat in a single unit, complete with its transmission and which does not transmit its power through the hull at any point.

The motor thus removed and placed ashore must be capable of being started, fed by its fuel tank.

The mounting supports fixed to the boat, the control levers, the tachometer with its connections, the battery with its conductors and the fuel tank and fuel lines do not form part of the motor.

The attachment angle and the height of the motor must remain fixed while the boat is under way. But it is allowed to change the attachment angle between a heat and another.

The use of powertrim is allowed for monohull boats provided with safety reinforced cockpit, per rule 509.

For all T classes, the centre of the propeller shaft (measured at the centre point of the rear end of the propeller shaft) **must be at least 20 mm below** the bottom of the boat measured at the lowest point of the bottom. No design of the hull, by fins, keels or convex shaped bottom to obtain a higher engine position is allowed. For boats with the power trim this height will be measured with the propeller shaft set parallel with the bottom of the boat.

This dimension will be checked in the "as raced" condition.

This dimension is affected by the attachment angle. In GT-15, GT-30, JT.250, T 250, T.400 and T. 550, it is not allowed to change the attachment angle by other means than pulling out and resetting tilt pin or by adjusting a thrust block on the outside of the transom for which adjustment tools must be required. It is only allowed to change the attachment angle when the boat is on land. After any change of the attachment angle the propeller shaft depth must be rechecked.

### **550.6.02**

To be homologated as stock motor, an outboard motor must be sold and advertised by an industrial firm as being manufactured in standard production series (that is to say with all parts interchangeable and with identical dimensions, weights and materials) for the propulsion of boats.

To be eligible for homologation, a minimum of 1000 units must have been built and assembled, certified by the manufacturer to the National Authority of the country of origin.

### **550.6.03**

The motor must be able to function at reduced speed.

### **550.6.04**

When the motor is in the water, the cooling must be effected by the homologated water circulation pump.

### **550.6.05**

An efficient gear changing system giving forward, neutral and astern movement is compulsory.

The control handle for the reverse gear, ready for use, must be within easy hand reach of the driver, when he is in the normal driving position. Manoeuvring of the boat astern, must be possible by selecting reverse gear.

### **550.6.06**

An electric or manual starter must assure a quick and easy start without external aids. It must be used as it was supplied by the manufacturer, no adjustment or alteration being allowed.

## **550.6.07 - SOLE MODIFICATIONS ALLOWED**

Only the following modifications are allowed:

1. All studs, screws, nuts, bolts and their washers are free as well as the method of locking them.
2. The original propeller may be replaced by another in accordance with 504.13. In classes T.750 and T.850 4 blades maximum.
3. The trim tab may be altered or removed to accommodate a propeller, except in classes T.750 and T.850.
4. The cooling system must be provided by the water pump.
5. Thermostats and pressure valves of the cooling system may be removed.
6. The steering mechanism may be altered. If the original steering bar is removed or new ones are installed, any openings created must be sealed to prevent the motor from pulling in additional air.
7. The dampers (shock absorbers) may be altered or removed.
8. The rubber mounts of the motor may be altered, removed or replaced.
9. Revolution counters, water temperature gauges, water pressure gauges and similar instruments can be installed.
10. Revolution limiters may be removed.
11. The gear interlock device on the starter may be removed.

12. Spark plugs are free.
13. Original carburettor jets may be replaced for another size.
14. Springs may be added to the throttle lever of the carburettors.
15. Re-boring is allowed, but only piston assemblies supplied by the manufacturer of the motor may be used within the cc-limit of the class. When ports in cylinders are adjusted to the dimensions specified in the homologation sheet, material may only be removed in the specified opening to a depth of 10 mm, to match the shape of the original adjacent connecting passage (channel) outside the adjusted port opening. This also applies to other openings in the motor for which the dimensions are specified in the homologation sheet.
16. A part which is dimensioned in the homologation sheet may be machined for the purpose of reaching that specific measure;
17. A part may be machined to attain the weight quoted in the homologation sheet without altering other criteria given for the part in question. It is not allowed to change the flywheel but balancing machining is allowed if the dimensions and weights provided for on the homologation sheet are respected;
18. Measurements not quoted in the homologation sheet shall only be checked by visual comparison with standard parts. As the actual manufacturing tolerances are not published, small differences between the inspected part and the reference part must be accepted.
19. The fuel connector in the lower cover may be removed and the fuel hose from the fuel tank connected directly to the fuel pump. If this is done the opening left after the connector and around the fuel hose must be sealed to prevent extra air entering inside of cover.
20. Electric fuel pumps may be added provided the fuel still runs through the original fuel system and no parts are removed or blocked off.
21. No parts may be added to the motor unless specified in this rule.
22. It is allowed to extend the starter cord of a rewind starter so that the starting handle can be reached from the cockpit

### 550.6.08 – LOW EMISSION ENGINES (GT)

Only low emission engines complying with 2006 EPA Regulations will be allowed in GT15, GT30, GT60, and GT90. Integral powertrim is allowed only for GT60 and GT90 (as supplied and fitted by the same engine manufacturer).

1. Only one battery is allowed to be fitted in the boat. Only a battery with the original standard voltage (12 Volt) is admitted for the start of the Engine (in respect of the rule) Batteries with a measured voltage higher than 15 Volt when the engine is not running are not allowed and will lead to disqualification.
2. The Pin Plug connection wire and cover of the ECU (Electronic control units) of the Engine is an integral part of the Engine; only original standard from manufacturer is allowed (in respect of the rules).

#### MODIFICATIONS NOT ALLOWED

- Alteration or modification of any powerhead components
- Removal of material from the powerhead for any reason except for allowed reboring (damaged parts have to be replaced by new ones).
- Blue printing\* of engine parts is not allowed. It must be in race condition "as manufactured". All inside surfaces of the intake manifold, intake ports, combustion chamber, and exhaust ports must be consistent in appearance with the images shown in the engine homologation document. Surfaces that are indicated to be "as cast" must show no signs of polishing, grinding, and/or sandblasting.
- ECU/PCMs equipped with race data memory, must not have the memory erased or modified without the prior permission of the technical inspector.
- Any information sourced by the technical inspector from the ECU/PCM's race data memory which does not correspond with the technical data declared by the manufacturer in the homologation file will be viewed as reason for disqualification.

## MODIFICATION ALLOWED

To repair a damaged Cylinder block, GT15 engines may have one cylinder bored to manufacturer-supplied oversize. GT30 may have two cylinders bored to manufacturer-supplied oversize. The remaining cylinders must remain at OEM size.

It is allowed to disable/remove the neutral switch and in gear starting protection wire.

The trim tab may be altered or removed to accommodate a propeller.

The rubber mounts of the engine may be replaced.

Power trim may be removed. The use of thrust block to adjust the trim angle is allowed.

Spark plug may be replaced with a non-modified standard spark plug with the same thread length.

Propeller nut is free.

Springs may be added to the throttle lever of the carburetors.

The original propeller may be replaced by another in accordance with 504.13.

For GT15 and GT30: Decompression devices fitted to the camshaft to assist in starting of the engine may be removed.

The following modifications from 550.6.7 are NOT applicable to low emission engine (sections): 1, 5, 10, 11, 12, 13, 15, 16, 17, 20 and 22.

From 503.04.2 section 3 and from section 2 last two sentences are not valid.

***The GT15 and GT 30 boats shall have an external power shut off switch to kill the engine installed on the port side of the cockpit cowling.***

## 550.7 - FUEL

See 508.01, 508.02, 508.06, 508.07, 508.08, 508.09, 508.10, 508.11.

## **560 - P750 CLASS**

560 UIM TITLES & TEAMS

561 CLASSES & HULLS Diagrams A, B & C

562 MACHINERY

563 MODIFICATIONS 564A TECHNICAL

564B GENERAL RACING REGULATIONS AND RULES – Diagram D, E and F

564C ADDITIONAL REGULATIONS FOR SURF DISCIPLINE

564D ADDITIONAL REGULATIONS FOR CIRCUIT DISCIPLINE

564E ADDITIONAL REGULATIONS FOR LONGHAUL DISCIPLINE

Diagram G – Guidance to Surf Course Diagram H – Guidance to Circuit Course

### **Abbreviations and dossier of terms:**

UIM – Union Internationale Motonautique; World Governing body of powerboat racing

Pre Scrutineering – At the beginning of the event

Safety Scrutineering – Carried out when required or between each discipline

Post Scrutineering – At the final heat of the discipline

Final Inspection – Inspected and measured to ensure legality

Driver – The person in control of the engine, steering, throttle and gears.

Co-Driver – The second person in the boat.

O.O.D – Officer of the day

Please note there are further definitions throughout the rules.

Note: Only other UIM Rules that also apply.

Code of Ethics

Anti-doping.

Environmental Code.

Group 100 rules.

Group 200 Rules

Group 300 Rules

Group 400 Rules

## **560.01- TITLES / TEAMS**

### **UIM P750 World Championship Series:**

1. Must have at least two of the three classes – Stock, Pro Stock and Modified
2. Two countries (National Authorities) must enter in each class to validate a UIM World titled event.
3. All 3 disciplines must be contended at a single event over the duration of a minimum of 7 days including 2 lay-days.

**UIM P750 Continental Championship Series:**

1. Must have at least two of the three classes – Stock, Pro Stock and Modified
2. Two countries (National Authorities) must enter in each class to validate a UIM Continental event.
3. ***Each discipline (Circuit, M-shape, and Endurance) must be contended at a single event per year over the duration of 2 days minimum.***

***On the first year, a Continental Circuit Championship will be organized, on the second year a Continental M-shape Championship and on the third year, a Continental Endurance Championship.***

***Three continental Country are defined: Europe, African-Asian and American.***

***The six first teams in Europe, African-Asian and American are directly qualified for the World Championship series.***

**UIM Southern Hemisphere Championship & UIM Northern Hemisphere Championship:**

1. Must have at least two of the three classes – Stock, Pro Stock and Modified
2. Two countries (National Authorities) must enter to validate a UIM Hemisphere Championship.
3. All 3 disciplines must be contended at a single event over the duration of a minimum of 4 days including 1 lay-day.

**All Series Championships:**

Can be staged at one event or be held during a calendar year at three separate venues/countries if allocated by the UIM P750 Working Group Committee and approved by Cominsport. Each venue/country organising one of the disciplines must include a minimum of two days racing per discipline. A series staged solely at one event must have all three disciplines, no single discipline will be recognized for any UIM title. A series held over three separate venues / countries will be awarded one of the disciplines. All three disciplines must enjoy equal points awarding system and accumulated to award a final Championship title per class. A P750 Series is made up of three individual disciplines.

**WORLD AND CONTINENTAL CLASSES**

Rule:	STOCK (S):	PRO STOCK (PRO):	MODIFIED (M):
UIM World & Continental Class,			
Southern & Northern Hemisphere series	YES	YES	YES

**560.02 - O.O.D (OFFICER OF THE DAY)**

The UIM will approve the O.O.D for all UIM titled events. Main Officials must have experience in P750 Racing (Safety Officer, Timing and Technical)

**560.03 - PRIZE PRESENTATION**

Prize presentation at UIM Titled events must be attended by all participants. Only the O.O.D can sanction a non attendance.

**560.04 - MINIMUM BOATS NUMBERS AND NATIONAL AUTHORITIES**

A minimum of three boats will constitute a valid class. For a UIM Titled event the minimum number of boats per class must be five and a minimum of two different countries (National Authorities).

**560.05 - LICENCE DETAILS**

All Drivers and Co-Drivers must hold a current International race licence for P750 Class issued by their own National Authority for International championships and a National licence as per driver or co-drivers National Authorities rules and regulations to compete nationally. UIM Rules 109.01, 109.02, 109.03, 109.04, 109.05, 109.06,

and 109.07 will apply. Note: Competitors taking prescribed medication must complete the UIM 'Therapeutic Use Exemptions TUE 'Form. For further information go to the UIM website – Anti Doping or contact your National Authority.

### 560.06 - FINAL INSPECTION

The organisers must ensure that at least the winning boat and engine are inspected and measured to ensure legality. It is optional to inspect or measure other boats in second and third place or any other boat. UIM Rules 503.04 will apply.

### 560.07 - TEAMS

Team = the designated Driver and a Co-Driver can contest these championships. In the event of a Co-Driver being injured a replacement of the Co-Driver only is permitted in all disciplines if:

A doctor/Paramedic's certificate is produced stating that the injury of the Co-Driver. The

O.O.D is satisfied with the doctor/paramedic's report.

The replacement co-driver has the complete current paperwork including a current international licence.

No Co-Driver can be changed during a heat, race or leg.

The Driver is the person in control of the engine, steering, throttle and gears

The Co-Driver is the second person in the boat who is not the Driver

The Co-Driver does not have to be of the same Nationality of the Driver.

### 560.08 - MINIMUM AGE

Age refers at the date of the event.

TEAM	STOCK (S)	PRO STOCK (Pro)	MODIFIED (M)
Min Age of Driver	16	17	18
Min Age of Co-Driver	16	16	16

### 560.09 - BEHAVIOUR

No abuse of officials will be tolerated. Any Driver, co-Driver or team members found guilty by admission, or by the jury, will result in the Driver/co-Driver being disqualified from the heat or discipline or total event. Only the O.O.D. or the UIM Commissioner can take this action. After a finding of gross infringement of the rules or a gross breach of good manners or sportsmanship, not covered by the above rule, the O.O.D. and/or the Race Jury may exclude a competitor from a heat/discipline or the whole event.

### 560.10- PROTESTS

All protests, jury formation, sanctions, appeals are to be as the Rules Group 400 (as with all other UIM classes). A Team / Driver can only protest another Team / Driver if they are in the same heat.

### 560.11 - PROTEST FEE

The protest fee must be announced in the advance programme. Protest fee: maximum of 80 Euros or equivalent in host's currency.



## 560.12 - ALCOHOL/DRUGS

Alcohol or drug abuse will result in a total ban from the event (see rule 205.02.02 / 03). Note: Competitors taking prescribed medication must complete the UIM 'Therapeutic Use Exemptions TUE 'Form. For further information go to the UIM website – Anti Doping or contact your National Authority.

## 560.13 - INSURANCES

All Drivers and Co-Drivers must abide by any mandatory medical and insurances carefully set out in the advance programme. Any costs charged by the organisers for supplying the same, must also be stipulated in the advance programme Max 90 Euros or equivalent in host's currency.

## 560.14 - PENALTIES/YELLOW/RED CARDS/BLUE CARDS

Rules 406 – Penalties will apply, although P750 Class penalties will supersede general rules.

Yellow/Red/Blue cards: see rules 406.05 these rules will be strictly enforced.

## 560.15 - DRIVERS BRIEFING

Any Driver/Co-Driver failing to attend any drivers briefing without prior consent from the O.O.D will be disqualified at the discretion of the O.O.D

## 560.16 - SAFETY EQUIPMENT

**HELMETS:**All racing helmets must be full faced helmets given to protect the skull base and cover the ears. At least 50% (area) of the helmet must be of fluorescent orange, red, yellow or international orange colour. The helmet colours must be bright enough to be clearly visible in the water. The wearer is entirely responsible for the efficiency of his helmet. The organisers are recommended to repeat this important rule in their advance programme and their race instructions. As per rule 205.07

**RACING VEST:** The efficiency of the racing vest is the sole responsibility of the wearer who must be assured that it conforms to the UIM rules and carries indelible confirmation of this. Buoyancy: A racing vest must have a minimum of 7.5 kg solid buoyancy for a person weighing up to 60 kgs and 9 kgs of buoyancy for those over 60 kg. As per rule 205.06.

It is mandatory for all drivers/co-drivers to wear a back protector with a racing vest unless one is built into the racing vest.

**CARRIED SAFETY EQUIPMENT:** Safety equipment as specified in each discipline must be carried at all times. Failure to do so will involve penalties as described in the relevant discipline. The boat number must be marked on all safety equipment.

**EYE PROTECTION:** Eye protection is mandatory in the Circuit and Surf discipline and advised for Longhails. This protection can be goggles or helmet visor.

**CLOTHING:** All limbs must be covered at all times including feet. Gloves optional.

## **561 - CLASSES/HULLS**

561 Reference rule 501 Measurement Certificate of the general rules – Measurement certificates are not required for P750.

### **561.00 - DISCIPLINES**

M Shape (Surf); Circuit and Longhaul

### **561.01 - HULLS LENGTHS AND WEIGHTS**

561 - HULLS

Number	Rule:	STOCK (S):	PRO STOCK (PRO):	MODIFIED (M):
.011	Engine Capacity	Up to 750cc	Up to 750cc	Up to 750cc
.012	Minimum hull length	3.8m	3.8m	3.8m
.013	Minimum hull width	1.7m	1.7m	1.7m
.015	Minimum overall weight	325kg	325kg	325 kg

Minimum overall weight .015 is the minimum weight of a complete rig, weighed directly after the race without fuel tanks or residual water, plus driver & Co-Driver with their personal safety equipment on that they have just raced in racing vest, helmet, wetsuit or dry suit.

To reach the minimum overall weight, ballast can be added. This must be securely placed and has to be of solid material and not liquid material.

### **561.02 - HULL DESIGN**

All boats must be of a tunnel hull design and conform to the original manufacturer's catalogue. The floorboards can be supplied by an alternative manufacture but must conform to rule 561.04. All boats must be fitted with a serial number plate issued by the manufacturer on either the nose cone or preferably the transom, showing the Model, Make, Date of Manufacture and if possible the maximum allowed horsepower of any relevant engine. A minimum number of 2 boats must have been made, advertised for sale and are commercially available before the model can be accepted to race. As long as the boats fit to the Class hull requirements, no measurement certificate is required as they are inflatable boats.

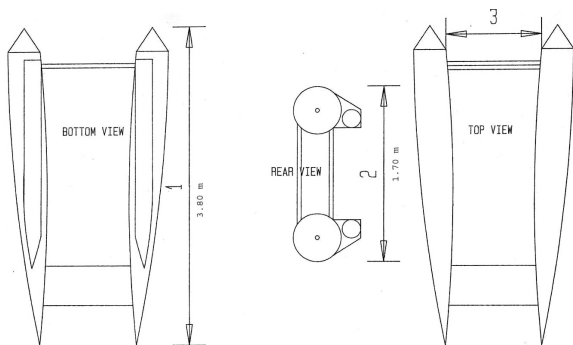
Motor height adjustment must be fixed while on the water.

All boats must conform to the following measurements:

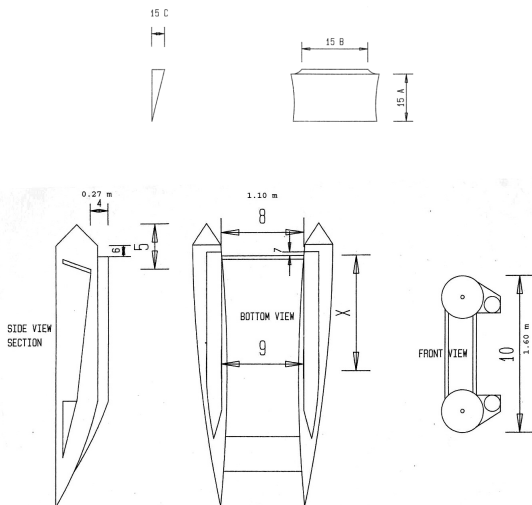
#### **SKETCHES:**

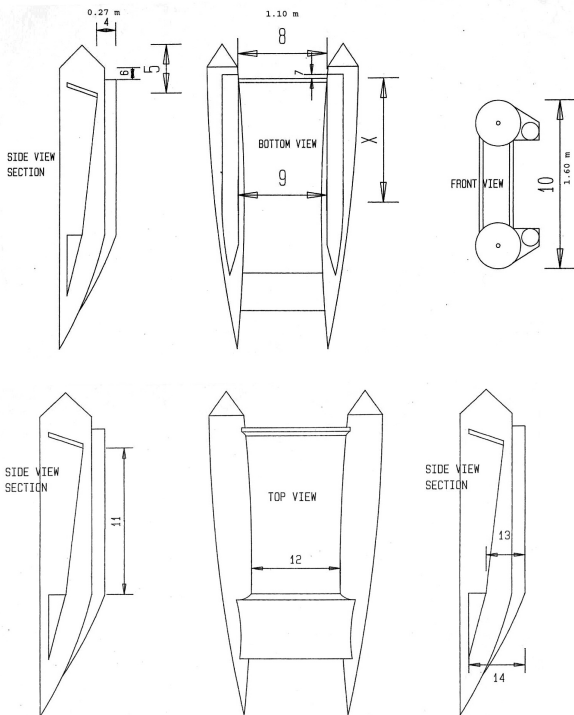
Measurements Number 4: minimum of 0.26m. Rear Transom to ground: Between Hi-jackers at rear measured at nearest points: Number 8: Minimum of 1.05m. Overall width front transom (measurement taken at back of nose cone). Other measurements to be added by agreement

## HULL DIAGRAM A:



## HULL DIAGRAM B:



**HULL DIAGRAM C:****561.03 - INFLATION OF HULLS**

They can only be inflated with atmospheric air and must have 3 independent compartments, except for pencil type boats where each pontoon must have 2 independent compartments. The boat must be able to float even if one compartment is not functioning.

**561.04 - DEFINITION OF HULLS**

All boats should be able to deflate, to collapse, foldable or to be able to be rolled up, so that no dismantled part has a length greater than 1/3 of the full length of the inflated boat including floorboards. No aerodynamic appendages are allowed.

### 561.05 - MODIFICATION ABOVE THE WATERLINE

Certain modifications above the waterline are allowed, these modifications will refer to foot straps, handles, loop patches only and not modifications that interfere with the original dimensions of the boat. A waterline is defined as the line taken when the boat is ready to race but without the Driver/Co-Driver. The waterline will be below the bottom of the transom if a multi-hull type. No part of the hull can be used for water ballast.

### 561.06 - SPLASH PLATE

A splash plate may be fitted to the back of the transom as long as it complies with Rule 561.05 plus the following dimensions: If this plate runs the full length of the transom, i.e. From pontoon to pontoon, then the width of this plate is restricted to 100 mm. If the width of this plate exceeds 100 mm then its length is restricted to 150 mm across the back of the transom, but may protrude as far back as the engine as required.

### 561.07 - MODIFICATION BELOW THE WATERLINE

Modifications below the waterline: Planing batons and strakes may be attached to the planing surface of the hijackers. Construction spray strakes are permitted anywhere on the outside of the hijacker cover.

### 561.08 - WINDOWS

Boat numbers can be painted or enclosed in two transparent covers, meeting the correct size and clearly visible. Rule: 561.09

### 561.09 - RACE NUMBERS

Must be at the bow of the boat a minimum of 18 cm x 3cm with a 2 cm square border round the boat number and on the engine cover must be 18 cm x 3 cm with a 2 cm border around the number. Their colour must be black letters on a white background. If the boat is white, then there must be a black boarder around the white square background.

### 561.10 - RIGHTING ROPES & BOWLINE

All boats must be fitted with two designated righting ropes/webbing. These ropes/webbing must not share common use. They must be at least 10 mm thick [rope] and the webbing minimum 25 mm wide. All boats must be fitted with a 4 meter length of similar material as a designated bowline, spliced or stitched eye at the end. The bowline must be fixed to the nose cone in a pouch glued/ fixed to the nosecone. Bowline must not be tied up in other ropes of the boat and must be easily accessible to be able to hook into the towing point on the bottom side of the nose cone. Towing points must be in the middle of the nosecones. Any towing point must be capable of pulling 300 kg.

### 561.11 - SPONSORS

The GRP bow of boat must be available for event sponsor's decals; failure will result in not passing scrutineering – requirements must be stated in Advance race instructions and stickers supplied by organisers. Cowling stickers may be supplied by the event organisers but must supply with the correct boat number registered and agreed when entering championship.

**562 - MACHINERY**

MACHINERY				
No.	RULE	STOCK (S):	PRO STOCK (PRO):	MODIFIED (M):
.1	Engines must be homologated using the UIM specifications. The only outboard engines allowed in these classes are:	1.Tohatsu 50 D2 2.Yamaha 50H per original UIM homologation	1.Tohatsu 50 D2 2.Yamaha 50H per original UIM homologation	1.Tohatsu 50D22. Yamaha 50H Both modified according to the rules.
.2	No other engine will be permitted until the UIM (Cominsport Group) homologate a "low emission" compatible engine for P750 style racing .Introduced min. 3 years after homologation.	YES	YES	YES
.3	Low idle – engines must be capable of functioning at low speeds	YES	YES	YES
.4	Water Pick-up – external water pick-ups wherever/however attached.	Are forbidden	Are forbidden	Free.
.5	Control Handle (Gear) – An efficient control handle giving forward, neutral and backward movement is mandatory. The control handle for a functioning reverse gear must be within easy reach of the driver.	YES	YES	YES
.6	KILL SWITCHES: The manual starter must ensure a quick and easy start with no external aids. The engine must be fitted with a "kill switch", operated with a lanyard no longer than 1.3 meters at its maximum extended length. The lanyard must be strong and very firmly fixed to the Driver. A second "kill switch" lanyard must be firmly attached to the Co-Driver at all times.  Lanyard failure / kill switch failure Will result in disqualification from the relevant race/heat or long-haul discipline. Refer to	YES	YES	YES

**562.07 - IRREPAIRABLE DAMAGE/DAMAGED HULL/ENGINE/LOWER UNIT**

If a boat, engine, or any part thereof becomes irreparable through a racing incident on the water during a discipline, then: The hull may be replaced. The engine may be replaced. The engine can be re-built. The underwater unit may be replaced. All subject to official inspection and official authorization before any attempt is made on replacement or repairs.

The hull, engine or any part thereof that is damaged beyond repair cannot be replaced during the actual heat being raced Exceptions: An irreparable hull can only be replaced by another if the OOD decides another competitor was responsible for the damage caused only during a race or training on the water. Any damaged part of the engine can be replaced with similar except the cylinder block. Underwater units that are damaged beyond repair can be changed provided they have the same gear ratio and from a similar homologated engine.

All changes must be sanctioned and supervised by the Scrutineer or an appointed official. All damaged parts including hulls must be kept in a secure place for any official inspection or pending possible protests. Any equipment subsequently found to be repairable will result in the driver being eliminated from the complete event. All costs pertaining to the stripping of additional equipment will be the responsibility of the competitor in question. A fee, as specified in the advance programme, must be paid to cover the inspection of any protested engines or equipment. These charges should be reasonable. When different disciplines are held on different days and no fully secure compound is available either overnight or days then all boats must be re-scrutinized before racing re-commences. Failures will result in the loss of all previously gained points.

## 562.08 - GEARBOX

Gearbox must not be interfered with or modified in Stock and Pro Stock Classes. Any normal wear and tear on the fin/skeg shall be limited to 10mm and must be seen to be racing wear and tear; all fins/skegs will be measured and must comply with Pre Scrutineering of each discipline. If illegal the team will be disqualified if unable to change prior to that heat or Longhaul discipline. A stainless steel cover, with the same characteristics as an original gearbox, can be used to protect the leading edges.

## 563 - MODIFICATIONS

MODIFICATIONS				
No.	RULE	STOCK (S):	PRO STOCK (PRO):	MODIFIED (M):
.1	Replacement:	The replacement of nuts or the addition of lock nuts, drilling and wiring, split-pinning or keying is allowed provided the screw and pins are similar.	As per Stock Class	As per Stock Class
.2	Gear interlock	The gear interlock device on the starter may be removed.	As per Stock Class	As per Stock Class
.3	Steering:	The steering bar and brackets may be re-enforced and additional steering bar may be mounted. The steering bars must be able to tilt independently from the motor. Strengthening of transom bracket and lower leg are permitted.	As per Stock Class	As per Stock Class
.4	Engine locking	Engine locking brackets may be removed.	As per Stock Class	As per Stock Class
.5	Engine cowling	The engine cowling may be secured by means other than or in addition to the standard means.	As per Stock Class	May be altered to increase air flow and secured by means other than or in addition to the standard means.
.6	Telltale	Telltale cooling pipe may be replaced with another pipe or other characteristics.	As per Stock Class	Free
.7	Splash plate	A splash plate may be fixed to the trunk of the motor as long as it is not rigid and that it is fitted above the cavitation plate.	As per Stock Class	As per Stock Class
.8	Crankshaft	The crankshaft may be welded or pinned as long as the dimensions of the crank after welding do not exceed the original manufactures dimensions and weight for crankshaft. Holes maybe drilled in the crankshaft to reduce weight. It is not allowed to reduce the diameter of the crankshaft.	As per Stock Class	As per Stock Class

MODIFICATIONS				
No.	RULE	STOCK (S):	PRO STOCK (PRO):	MODIFIED (M):
.9	Propellers:	The original propeller maybe replaced by any other propeller; provided that it has a through the hub exhaust (see 504.13). The locking nut, spacer, adaptor, split pin, thrush washer/ washers are free for the securing of the propeller; Re-bushing and keying of propellers are allowed. No holes or ventilation slots of any nature whatsoever are allowed in the hub or blade. No spacing out of propeller to allow venting. Propeller must enter gearbox housing by a minimum of 5mm. Transgression of this rule will lead to disqualification. Propellers must be manufactured from Stainless-Steel or Aluminum.	As per Stock Class	Free
.10	Re-boring	Re-boring is allowed as per UIM homologation specifications. Parts must be as supplied by the original manufacturer. No aftermarket parts can be fitted. Oversize pistons can be fitted providing the total cc's does not exceed 750cc.	As per Stock Class	Allowed up to a max of 750cc
.11	Ports	When ports in cylinders are adjusted to the dimensions specified in the homologation sheet, material may only be removed in the specified opening to a depth of 10mm not including liner, to match the shape of the original adjacent connecting passage (channel) outside the adjusted port opening. Should the modified port window be smaller than the track, the track may not be tampered with.	As Stock Class	Free
.12	Parts	No part of the engine can be changed with another manufacture's or pirate part, except for the tiller arm. Tiller arm bracket, gear change lever.	As per Stock Class	Parts may be changed with another manufacture.
.13	Air box	Maximum of 1 x 6 mm hole may be drilled in the lowest part of the air box to allow water to drain from it.	As per Stock Class	Free
.14	Spark plugs	Original complete spark plugs and HT leads may be replaced.	As per Stock Class	As per stock Class



MODIFICATIONS				
No.	RULE	STOCK (S):	PRO STOCK (PRO):	MODIFIED (M):
.15	Auto lube & engine mounts	All auto lube and any relevant parts may be removed. Engine mountings may be replaced with rigid or rubber mounts with similar characteristics.	As per Stock Class	As per stock Class
.16	Throttle lever	Springs may be added to the throttle lever of the carburetors Tohatsu D1 Throttle cam can be used on the Tohatsu D2 Engine.	As per Stock Class	Free
.17	Emulsion tubes	Emulsion tubes are to be standard "off the shelf" items and have the same prerequisites as the jets. No modifications are allowed to these parts.	As per Stock Class	Free
.18	Baffle plate	As homologated, no baffles.	Previous standard	Free
.19	Steering	It's allowed to change bearings with similar characteristics. Steering dampers may be fitted. Steering by a tiller arm is required.	As per Stock Class	As per Stock Class
.20	Reeds	Standard reeds only as supplied by the manufacturer for the specific model of engine.	Reeds only are free. The stoppers must not be removed.	Reed valves system (support and reeds) are free
.21	Machining:	Skimming, grinding or machining is allowed as long as it meets the UIM homologation measurements.	As per Stock Class	Free
.22	Starters:	Electric starters are not allowed.	As per Stock Class	As per Stock Class
.23	Thermostats:	Thermostats of the cooling circuit may not be removed.	As per Stock Class	Free
.24	Revolution limiters:	Rev Limiters, heat sensors and lighting coils must not be removed. Rev limiter wire connections must be continuous and must be soldered to achieve this. Any tampering that might alter or delay the rev limiter in its proper homologated function will be classed as an infringement of this rule. Ignorance of the above will not be accepted as a defense and the competitor will be disqualified.	Can be removed	Can be removed.
.25	Jets:	Jets have to be to the UIM homologation specification.	Free	Free
.26	Weight of part:	A part, the weight of which is quoted in the homologation sheet, may be machined for the specific purpose of reaching the quoted weight only. It is not allowed to change the flywheel, but balance machining is allowed if the dimensions and weights are still correct.	As per Stock Class	No restriction on weights quoted.

MODIFICATIONS				
No.	RULE	STOCK (S):	PRO STOCK (PRO):	MODIFIED (M):
.27	Measurements:	Measurements not quoted in the homologation sheet may not be altered in any form whatsoever. If details cannot be verified with the aid of the pictures in the homologation sheet, then the part in question must be compared physically to a similar, but stock part for the relevant engine For the Tohatsu D2 engine exhaust port only: There is a casting mark on the inside of the engine exhaust port that does vary in size from engine to engine. This casting mark can be reduced no less than 0.5mm this will be considered to be a breach of the technical rules and can be disqualified.	As per Stock Class	Measurements not quoted in the homologation sheet may be altered.
.28	Altering parts:	Only parts where the dimension is quoted in the homologation specification may be altered for the purpose of reaching that specific measurement. The shape of the parts cannot change e.g. The shape of the cylinder head squish pan) The Block height measured from the centre line to the top of the block is allowed, all measurements according to UIM homologation papers.	As per Stock Class	Parts may be changed by another manufacture.
.29	Kill Switch:	It is not allowed to exchange kill switches from one manufacturer to another. The toggle type switch that can be activated without the insertion of the "curly cord" is forbidden. Refer to rule 562.6	As per Stock Class	It is allowed to exchange kill switches from one manufacturer to another. However, the toggle type switch that can be activated without the insertion of the "curly cord" is forbidden.
.30	Exhaust trunk	No modifications.	As per Stock Class	Holes may be drilled or cut into the exhaust trunk but no external appendages may be added
.31	Gear Box	See rule: 562.08	See rule:562.08	Bullet or racing gearboxes are allowed in this class only. Free. Bullet or racing gearboxes including free gear ratios allowed.

.32	Protrusions	No protrusions other than standard are allowed.	As per Stock Class	As per Stock Class
.33	Exhaust box	No protruding expansion exhaust box.	As per Stock Class	As per Stock Class
.34	External water pick-up	Not allowed.	As per Stock Class	Are allowed

### 563.34 - FUEL

Stock and Pro Stock Class: Fuel must be a commercially available grade of automobile unleaded fuel to a maximum of 99 octane, freely available from any normal petrol station. To maximise the equality of competition and to simplify the checking of conformity, the organisers must arrange the supply of the same fuel for all competitors at all UIM titled events. It does not necessarily have to be free of charge.

Modified Class: Only fuel to a maximum of 102 octanes is allowed. This includes Avgas.

Banned Fuel: Special racing fuels, methanol, nitro-methane and the likes thereof are expressly forbidden. The use of additives aimed at increasing the power of the engine is prohibited to either the fuel or the air intake. The use of nitrous oxide injection is also totally prohibited.

### 563.35 - FUEL DETAILS AVAILABLE:

The Driver/Co-Driver may not withhold the type of fuel/oil used if requested by race officials.

### 563.36 - OIL

A sample sealed container of the oil used, will be supplied by the competitor with unbroken seal, and then held by the organisers for the duration of the event in the event of fuel tests. It is a recommendation that Bio-degradable oil should be used to assist in the reduction of the environmental impact of the sport. No power enhancing oil is allowed.

### 563.37 - FUEL TANKS

Only the original fuel tanks as supplied with the engine, collapsible fuel cells or approved marine manufacturers tanks are allowed.

### 563.38 - FUEL MIX

No Driver / Co-Driver may withhold the type of fuel/oil used and the mixing ratio if requested by officials.

## 564A - TECHNICAL

TECHNICAL				
No. 564A.	RULE	STOCK (S):	PRO STOCK (PRO):	MODIFIED (M):
.1	Pistons	Where a dimension is quoted on a piston, metal may be removed to reach a specific weight, provided the dimensions are maintained. Should there still be an excess of weight, this may be removed from the inside of the piston i.e. the inside of the skirt or the area where the gudgeoned pin goes through.	As per Stock Class	N/A

2	Flywheel	It is not allowed to reduce the outside diameter or to change the flywheel. Weight reduction can only be done by drilling holes in the starter gear ring, only by a maximum of 8mm diameter and maximum depth of 4mm per hole. Balance machining by drilling holes in the area stated is allowed if the dimensions and weights are correct as per UIM homologation.	As per Stock Class	Allowed to remove starter ring (the horizontal disk attached to the flywheel dome)
---	----------	---	--------------------	--

TECHNICAL				
No. 564A.	RULE	STOCK (S):	PRO STOCK (PRO):	MODIFIED (M):
3	Conrods	It is allowed to reduce the overall weight of the Conrods by removing the flashing on the shank of all three rods to attain the weight specified provided for in the homologation specifications.	As per Stock Class	As per Stock Class
4	Electrical components	It is forbidden to remove any excess wiring; heat sensors modify coils, to rewire coils or other components, to tamper with CDI units or to add any electrical components (starter etc.) or any other part that is not standard original part.	It is allowed to remove any excess wiring i.e. heat sensors, rev limiters, low oil sensors etc. It is forbidden to modify coils, to rewire coils or other components, to tamper with CDI units or to add any electrical components (starter etc.) or any other part that is not standard original part.	Free
5	Head Volume	It is allowed to encroach into the squish pan area in the skimming process as long as the minimum combustion chamber is maintained. It is not allowed, should this minimum be exceeded, to remove the metal within the squish pan area to regain the lost volume. Measurement of the head volume will be taken with the head removed from the block.	As per Stock Class	No restrictions

.6	Head Volume Measuring procedure and modification of engine Ports	The head volume is measured off the block, using a glass plate of minimum 3 mm thick. A burette calibrated in 50 cc increments to be used with a paraffin/oil mix of 50/50. All head volumes to be taken with the spark Plug as used and correctly fitted. The head is measured with no gasket. All old gasket material is allowed to be cleaned off. It is also allowed to clean all carbon deposits in the head. The glass plate must be sealed with a thin layer of marine grease When ports in cylinders are adjusted to the dimensions specified in the homologation sheet, material may only be removed in the specified opening to a depth of 10mm not including liner, to match the shape of the original adjacent connecting passage (channel) outside the adjusted port opening.	As per Stock Class	No restrictions
----	--	--	--------------------	-----------------

TECHNICAL				
No. 564A.	RULE	STOCK (S):	PRO STOCK (PRO):	MODIFIED (M):
		This also applies to other openings in the motor for which the dimensions are specified in the homologation sheet. Should the modified port window be smaller than the track, the track may not be tampered with.		
.7	Throttle advance	On various models, it is allowed to change the position of the throttle cable link pin on the advance cam. It is not allowed to modify the cam itself or change the radius on the cam. [See 563.16.]	As per Stock Class	Free
.8	Cost of inspection	Costs may not be claimed in the case of a mandatory inspection by race authority. The maximum costs that may be claimed, by a driver from a protestor, should the equipment found to be legal, are as follows: LABOUR: Time may only be claimed to a maximum of six hours at a rate to be determined by their local class association or National Authority. Any excess will be borne by the owner of the equipment. The above cost excludes the cost of gaskets required or lubes which may only be changed as per the recommended grade in the workshop manual. Freight charges, where applicable, will be charged as per the standard international rates.	As per Stock Class	As per Stock Class

.9	Technical inspections	The O.O.D. or official scrutineer will be in charge. Only the following may attend the post-race engine inspections regardless of a protest being lodged. The O.O.D - UIM commissioner - Measuring Officer - Driver and his mechanic (or representative) - Protestor or his representative - Any other person the O.O.D. requires, with his permission. Note that in the case of a protest, the protestor's duty is to ensure that the inspection complies with his protest requirements. He may not however physically inspect the parts himself and should not be allowed within a 5m radius of the equipment.	As per Stock Class	As per Stock Class
.10	Standard Part	In the circumstances where weights and measurements are not quoted nor listed in the homologation sheets then comparative parts maybe used to determine legality.	As per Stock Class	Free
.11	Fuel	See rules 563.34 fuel regulations. Rule 563.36 Oil to be supplied by competitor unless otherwise specified.	As per Stock Class	To a max of 102 octanes is allowed this includes AV Gas.

TECHNICAL				
No. 564A.	RULE	STOCK (S):	PRO STOCK (PRO):	MODIFIED (M):
.12	Over blended or spark eroded engines	Engines not conforming to UIM and manufacturers homologation specification with regard to the blend rule and that have had tract widening done by any method inclusive of spark eroding, will only be allowed to compete in the modified class.	As per Stock Class	As per Stock Class
.13	Post race inspection	The post race inspection is to be a complete inspection and is not to be limited to any specific area. Post race inspection should mainly be about speed and power enhancing matters.	As per Stock Class	As per Stock Class
.14	Failure to appear	Any competitor refusing to have his racing equipment inspected for legality at any reasonable time during the whole event will be disqualified.	As per Stock Class	As per Stock Class
.15	Non OEM parts	In the case where original parts are not available, permission must be obtained from the UIM Cominsport to use substitute components. Such a request must be in writing. Any outboard motors that have superseded engine parts listed by the manufacture, supplied from the factory and confirmed in writing by the UIM Cominsport may be used. It is not allowed to interchange parts from one homologated model to another unless specified. Only D2 parts can be used in a Tohatsu D2 engine except for the D1 throttle cam.	As per Stock Class but for the Tohatsu D2 engine the D1 exhaust tube may be used in this class.	Parts may be changed with another manufacturer.

Cylinder head is a standard part for stock and pro-stock. Cylinder head is free for a modified class

## 564B - RACING REGULATIONS AND RULES

RACING REGULATIONS AND RULES				
No. 564B	Rule	The M 'Shape (Surf)	Circuit	Longhaul
.01	Race Course:	<p>Shown diagrammatically in diagram D as a guide only. Starts for this discipline should be Beach Wet Start or Beach Le Mans.</p> <p>Note 1: Any form of start procedure listed as per the P750 rules may be used and the start procedure that is most suited to the current conditions should be used.</p> <p>Note 2: There does not have to be breaking Surf in order to engage in this discipline, although it should take place on a suitable beach where possible. If the water conditions are flat then the O.O.D should brief the drivers to maintain</p>	<p>Diagram E. This is a guide only, the course can change shape due to the size of the water available. Course size should be shown in the advance race instructions. Starts for this discipline should be flag or jetty start from pontoon or beach. Note 1: Any form of start procedure listed as per the P750 rules may be used and the start</p>	<p>Should be run over a maximum distance of 150kms to a minimum of 80kms. Minimum lap distance of 10kms and should be area bound. The organisers must provide a boat/s prior to the race to show teams the course by water, explaining any safety issues. This event can be staged in two legs in one day or over two days, having individual legs of a minimum of 60kms per leg and a maximum of 150kms in total, it must be stated in the advance program.</p> <p><u>Ultra Long-haul:</u> Over 150kms. The organisers will provide an extended list of extra rules for</p>

RACING REGULATIONS AND RULES				
No. 564B	Rule	The M 'Shape (Surf)	Circuit	Longhaul
		<p>their lanes and may decide to add a 1A mark further out for the start lap only to enable a longer start run.</p>	<p>procedure that is most suited to the current conditions should be used.</p>	<p>the event, including race regulations that should be read in conjunction with the UIM Rules in the advance programme. This event can be staged over several days having individual legs. Starts for this discipline can be any form of start procedure listed as per the P750 Rules. The race may not exceed 2h30. The leading boat will be declared the winner (and subsequent boats scored as they finish) after completing the next lap.</p>
.02	Wet Driver: (manoverboard)	<p>If any Pilot or Co-Pilot lands completely in the water or a boat get stuck on the beach during racing, the race will be stopped immediately, even before the red flag is flown. All competitors must stop, then come off the plane, clear the course and proceed to the line with extreme caution or as stated in Drivers Briefing. No re-fuelling, or changing set-up and get ready for an</p>	<p>As per Surf except all restarts and re runs take place from the jetty/pontoon or beach and rule 564D.05 (Re-Run).</p>	<p>Only if required by the OOD the Red Flag will be raised; the race will not stop if someone goes into the water in this discipline.</p>

		re-run. The boat causing the stoppage is not allowed in any re-runs of that heat. Penalties are carried forward to any re-run/start of that heat. Any boat that gets stuck on the beach may only re-start with the O.O.D.'s permission. If more than 2/3 of the race or re-start/run race has been completed then no re-run is required. Restart can be from the beach or deep water start.		
.03	Racing buoys	If a competitor misses or rides over a buoy and crosses the racing line on the inside of the course, he will be disqualified from that heat at the O.O.D.'s discretion.	As per Surf.	Deviation of the set course markers will result in disqualifications.
.04	Additional Penalties	The O.O.D must state at Drivers Briefing if there are any additional penalties that could occur on or off the water due to Force Majeure under the grounds of safety.	As per Surf.	As per Surf.

RACING REGULATIONS AND RULES				
No.	Rule	The M 'Shape (Surf)	Circuit	Longhaul
564B				
.05	Missing Buoys / deviation from the course.	If a Driver misses a buoy, he can re-take it if he has not crossed the racing line on the inside of the course. The boat in question does not have the right of way when re-entering the race course and must give-way to any competitor already on the correct course.	As per Surf.	Deviation of the set course markers will result in disqualifications.



.06	Damaging buoys	If a competitor destroys or damages a buoy and causes the race to be red flagged he will be disqualified from that heat and any restart of that heat. The competitor must pay the organiser the cost of a replacement buoy which sum must be in the advance programme. If not in the advance programme then the competitor can refuse to pay. If a competitor damages a buoy but the race is not red flagged, he will be deducted 3 points and the competitor must pay the organiser the cost of a replacement buoy and tackle, which sum must be in the advance programme.	As per Surf.	As per Surf.
.07	Bumping	<u>Deliberate</u> bumping of another competitor is strictly forbidden and will result in the disqualification from that heat or re-start/re-run and possible disqualification from the whole discipline if seen by the O.O.D as reckless and dangerous driving. Other UIM penalties may also be given.	As per Surf.	As per Surf.
.08	Crashing	If one boat lands on another, the offending boat or boats will be disqualified from that heat/race.	As per Surf.	As per Surf.
.09	Close Driving Tail-Gaiting, Zig-zaging or Snaking	The O.O.D may enforce penalties including disqualification and or Yellow / Red Cards for the following infringements: 1. A boat that follows dangerously close or directly behind (tailing gaiting) 2. A boat that is snaking in front of another boat or repeatedly changing lanes in front of another competitor.	As per Surf.	As per Surf.

RACING REGULATIONS AND RULES				
No.	Rule	The M 'Shape (Surf)	Circuit	Longhaul
564B		If the competitor repeatedly offends during the discipline the O.O.D can disqualify the team from that discipline.		

.10	T Bone	If any boat collides mid-ship with another (T-Bone) the offending boat will result in immediate disqualification from that heat / race. Other UIM penalties may also be given.	As per Surf.	As per Surf.
.11	Shore Buoys	There should be a minimum of 10 meters between the shore buoys and the shore with sufficient water depth to race approximately 0.5m. This must also be evaluated in the Event risk assessment.	As per Surf.	As per Surf.
.12	Race distance	All heats should include a start lap plus 6 laps and the final will be a start lap plus 9 laps for all classes unless stated in the Advance Race Instructions or at the O.O.D / Race Committees discretion due to weather conditions. In the case of force majeure laps, race distance & heats may be altered by the O.O.D. Every effort should be made to implement the amount of laps as per the rules. STOPPING A HEAT AND NOT HAVING A RE-RUN: If the heat has to be curtailed and more than 2/3rd of the heat has been completed (full laps rounded / distance covered) then a result can be posted.	As per Surf. Equalising laps: A 6 lap heat includes a start lap plus one equalising lap and the 9 lap final includes a start lap plus 2 equalising laps. In the case of force majeure, race distance and heats may be altered by the OOD. Every effort should be made to implement the required amount of laps as per the rules. STOPPING A HEAT AND NOT HAVING A RE-RUN: If the heat has to be curtailed and more than 2/3rd of the heat has been completed (full laps rounded up / distance covered) then a result can be posted. In the Circuit discipline all boats must have completed their equaliser laps.	Rule 564B.1 Long-haul STOPPING A RACE AND NOT has to be curtailed and more than 2/3rd of the race has been completed (full laps rounded / distance covered) then a result can be posted.

RACING REGULATIONS AND RULES				
No. 564B	Rule	The M 'Shape (Surf)	Circuit	Longhaul
.13	Race Finish / Time Allowance.	<p>The race finishes when the lead (1st Place) boat crosses the finishing line. Any boat that has not completed 2/3rds of the race (full laps rounded up) when the winner crosses the finishing line will not score any points for that heat. All boats must cross the finish line on the water either by their own power or paddle power to be classified and eligible for points. Boats must proceed around the buoy beyond the start /finish line to the designated muster area as described at drivers briefing and wait for the red flag to be shown from the shore as the signal to return. Drivers failing to do this can be penalised or disqualified by the O.O.D.</p>	As per Surf.	A boat must cross the finish line on the water, under its own power, or by paddle power, to receive an elapsed time / position for the leg / race. The cut-off time for the last competitor to cross the line is 1.5 x the first boat's time in that specific class or as per Drivers Briefing. Once a boat has crossed the finish line, it may not cross back and re-enter the race/leg until the finish line is officially closed. Re-entering will result in disqualification. All safety procedures will be kept in place until all boats are accounted for.
.14	Minimum & Maximum number of boats	There will be minimum 3 and maximum 12 boats to make a race. In the event of the entry exceeding 12 boats, then eliminating heats will be run as per rule 564B.30.	As per Surf.	There is no maximum; but the evaluation for safety must be in the event risk assessment.
.15	Awarding Final points	<p>1. The total points for the qualifying heats plus the final heat (double points) of the top 12 boats will be added together to determine the overall 1<sup>st</sup> – 12<sup>th</sup> positions; then converted to single points for that discipline as per Rule: 564B.31</p> <p>2. The remainder of the fleet will be awarded points as per their positions after the qualifying heats. 13<sup>th</sup> Place will receive 3 points, 14<sup>th</sup> Place – 2 points, then 15<sup>th</sup> Place and the remainder of the finishers will all receive 1 point as per Rule: 564B.31</p>	As per Surf.	Single points are awarded as per Rule: 564B.31

RACING REGULATIONS AND RULES				
No. 564B	Rule	The M 'Shape (Surf)	Circuit	Longhaul
.16	Burst hull or helmet loss	If a boat should burst or deflate rapidly during a race for any reason, that driver must cease racing, remove the boat from the race course and continue to shore in a safe manner. If a Driver or Co-Driver loses his helmet, they must immediately stop racing; a red flag will be shown and the boat in question will be disqualified from the heat. Further penalties may be invoked if enquiries lead to a failure due to any error by the person incurring the loss.	As per Surf.	If a boat should burst or deflate rapidly during a race for any reason, that driver must cease racing, remove the boat from the race course and continue to shore in a safe manner or call for immediate assistance from the safety fleet. The boat in question will be disqualified from the race or leg. If a Driver or Co-Driver loses his helmet, they must immediately stop racing and remove the boat from the race course and continue to shore in a safe manner or go to a safety boat for assistance. The boat in question will be disqualified from the race or leg. Further penalties may be invoked if enquiries lead to a failure due to any error by the person incurring the loss.
.17	Flags	All flag signals except the green flag will conform to the UIM Rule 304.02. National authorities may have exceptions but must notify teams at Drivers Briefing and in the Advance Race Instructions.	As per Surf. P750 use the Yellow and Green Flags for starting the Circuit class.	As per Surf, but no 'last lap' flag is used if not a circuit longhaul.
.18	Flag acknowledgement	All competitors must acknowledge all flag signals to the official giving the signal, unless stated in Drivers Briefing by the O.O.D. Failure may lead to the loss of 2 points at the discretion of the O.O.D.	As per Surf. All competitors must acknowledge all flag signals to the official giving the signal, unless stated in Drivers Briefing by the O.O.D. Failure may lead to the loss of 2 points at the discretion of the OOD.	As per Surf.
.19	Race Starts	As per Rule: 564C	As per Rule: 564D On a restart the boats must go back to original starting grid positions of that heat as not everyone boat may have completed their equaliser laps.	As per Rule: 564E.02

RACING REGULATIONS AND RULES				
No. 564B	Rule	The M 'Shape (Surf)	Circuit	Longhaul
.20	Race Live	The race will be live when the green flag drops. The heat is live when the last running boat crosses the start/finish line for the first time. If the last boat has not passed the start/finish line, then the re-start is for the full amount of laps with no re-fuelling or changing set-ups.	As per Surf.	The race will be live (Start) when the Green flag drops.
.21	Race finish	The race finishes when the lead/1 <sup>st</sup> boat crosses the finishing line. (Chequered flag). Boats must go to the designated Finishing Muster area as described in Drivers Briefing. Drivers failing to do this can be penalised or disqualified by the O.O.D. Boats that have not completed 2/3rd of the race (full laps rounded up) when the winner crosses the finish line will not score any points for that heat. All boats must cross the finishing line (chequered flag) to be awarded points.	As per Surf.	A boat must cross the finish line under power or by paddle to be awarded points. Once a boat has crossed the finish line, it may not cross back and re-enter the race/leg until the finish line is officially closed. Re-entering will result in disqualification.
.22	Safety equipment	Paddles x 2 Designated righting rope/webbing x 2 Designated Bowline. Kill switches x 2.	As per Surf.	Rule: 564E.03
.23	Eliminating heats	START POSITIONS M Shape (Surf) To select pole/grid positions and a draw is required, it must take place at Drivers Briefing in front of the Teams. See rule 564B.30	As per Surf.	As per Surf.
.24	Laps	All equalising heats will have a start lap plus 6 laps and a start lap plus 9 laps for the Final heat for all classes unless stated in the Advance Race Instructions or at the O.O.D / Race Committees discretion. See Rule 564B.12	As per Surf. If a Start / restart / re-run is required of 6 or 4 laps only 1 equalizer lap is required. 9 lap final will have 2 equalising laps included. See Rule 564B.12	Not applicable. See Rule 564B.12

RACING REGULATIONS AND RULES				
No. 564B	Rule	The M 'Shape (Surf)	Circuit	Longhaul
.25	Outside assistance	No person shall provide or receive outside assistance from the air, water or by radio during the race. There shall be no outside assistance allowed in a re-run / re-start unless the O.O.D has allowed an assistant to hold boats on the start. If an engine has not fired on the start line then original crew assistance may be given providing that the O.O.D has allowed an assistant on the original start. If the crew or boat are deemed to be at risk at any-time then the O.O.D may order them to withdraw from the start line. Failure to observe this rule will result in disqualification from the race.	As per Surf.	As per Surf. A handheld GPS can be used.
.26	Definition of a 'Race'	when the green flag is dropped and the chequered flag is raised, Rules 56B.20 / 21.	As per Surf.	As per Surf.
.27	Definition of a 'Heat'	Part of a number of races that provide an elimination process to get to the Final race of either the circuit or surf disciplines.	As per Surf.	Not applicable.
.28	Definition of a 'Leg'	Not applicable.	Not applicable.	A Leg can be part of a Long-haul, if the discipline is divided into sections or staged over a period of days.
.29	Definition of a 'Group'	Group: When there are more than 12 boats in a class, the class must be split into groups for the eliminating heats.	As per Surf.	Not applicable.

### 564B.30 GRID POSITIONS FOR INTERNATIONAL EVENTS

The first heat of any UIM championship has to be authorised by the organisers. At all UIM titled events the following will apply.

1. The grid positions for the first heat / race or leg (Ultra Long-haul) of which ever discipline is run first will allocate pole position to the previous equivalent Championship overall winner if they are competing within the event. (Example World Champion takes pole position). All other Drivers will have their positions draw by a random method (out of a hat) at Drivers Briefing in front of the teams.
2. If there are more than 12 boats in a class, the teams will be divided into groups; the teams should be evenly split (where possible) into groups irrespective of nationality. E.g. Position 1 into Group 1 - Position 2 into Group 2 - Position 3 into Group 1 etc. following the same allocation process until all teams placed. In the case of no previous championship placing's being available the groups will be determined using race numbers to draw their positions.
3. Only the Driver's names are taken into account when forming the grid positions. Any Co-Drivers names are discounted.

- In the case of equal points (tie) for the final grid positions, the highest heat positions will be used (amount of 1st, 2nd, and 3rd respective). If there is still a tie, then a draw between the tied positions will take place in front of the relevant teams by the O.O.D. In the Surf and Circuit disciplines : If there is a draw in the overall final winning positions of that discipline, the equalising heats will be used using the highest heat positions gained to determine the winning order; if there is still a draw, the final heat result will be included in the calculation.
- Final Championship points: In the event of a tie in the points then the highest placed result in all three discipline finals will be used.

### 564B.31 - POINTS & GUIDELINE TO ELIMINATING HEATS

In the event of there being more than 12 boats entered in the same class eliminating heats will be run in the M Shape (Surf) and Circuit discipline. In the Long-haul discipline single points will be used as all boats race together.

#### POINTS:

##### SINGLE POINTS

1st	20	5th	11	9th	7	13th	3
2nd	17	6th	10	10th	6	14th	2
3rd	15	7th	9	11th	5	15th	1
4th	13	8th	8	12th	4	PLUS 15th	1

Guideline for eliminating heats for more than 12 in a class.

- Each 'Group' must race a minimum of 2 heats.
- Each 'Team' should be in 2 groups per day.
- Each 'Team' therefore races a minimum of 4 heats and the top 12 boats in the class will race in the final.
- At Drivers Briefing all teams will be randomly drawn and put into groups for the morning and then redrawn for the afternoon heats.
- The winning team in each class from the previous discipline/equivalent championship will take pole position in their group for the first morning heat. The afternoon groups will use their grid positions that were randomly drawn at Drivers Briefing.
- After each heat the points will be added to a team's individual running total during the day.
- After the last heat the points will be added together and go towards their overall results and will confirm the top 12 positions who will compete in the final race. The final race is for double points, their points added to their existing heat points to confirm the overall positions from 1<sup>st</sup> – 12<sup>th</sup> place; then worked back at the end of the discipline to single points.
- All other teams below 12<sup>th</sup> place will take single points thereafter, to give overall final results.

#### HEATS: START LAP PLUS 6 LAPS FOR CIRCUIT AND M SHAPE (SURF) DISCIPLINES. START / 9

MORNING	Heat 1	Heat 2	Heat 3	BREAK	AFTERNOON	Heat 4	Heat 5	Heat 6	FINAL
GROUP A	1	2	3		GROUP Y	4	5	6	THE TOP
GROUP B	1	2	3		GROUP Z	4	5	6	12 BOATS
									OVERALL

### 564B.32 - DANGEROUS DRIVING

Dangerous or reckless driving will lead to disqualification from that heat or discipline. Intentionally causing damage to another boat or bodily harm to a competitor will result in disqualification from that discipline or the whole event at the O.O.D's discretion. Further penalties may be applied.

### 564B.33 - OVERLAP

- I. If overtaking on the inside an overlap is only established when two boats are approximately on the same course, and the boats are parallel to each other.
- II. When overtaking from the outside an overlap is established when the overtaking boat has passed the overtaken boat sufficiently to change direction without contact.
- III. The lead boat has the right of way until an overlap is established.
- IV. A safe overlap is the responsibility of the overtaking boat.
- V. An overlap can occur from left or right.
- VI. An overlap may not be established on the inside of the actual race course.

### 564B.34 - OVERTAKING

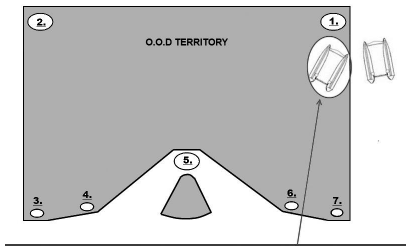
An overtaking boat shall keep clear of the boat that is being overtaken.

### 564B.35 - PASSING MARKS

When trying to overtake a boat on the inside, the Driver must anticipate the possible direction of the boat he is trying to overtake and must take all necessary action to avoid a collision.

- I. When passing a turn buoy and an overlap has been established, both boats must maintain a safe distance from each other and from the turn buoy.
- II. Once an overlap has been established the overtaking boat must give the overtaken boat room to clear any course markers.

DIAGRAM D: OOD Territory – area in which a race boat can cross but loses its 'right of way' to other racers (must give way in this area).



Can be in O.O.D Territory but loses all rights and must give way to raceboats on the course line.



DIAGRAM E: Over Taking

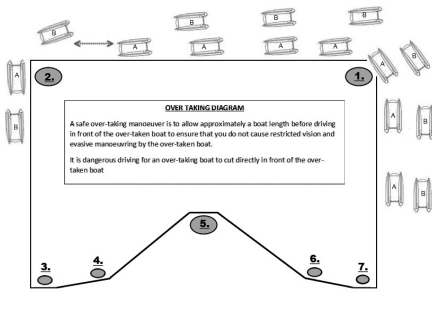
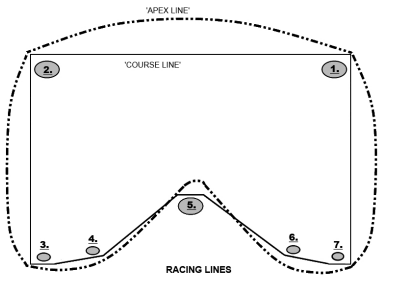


DIAGRAM F: Racing Lines



## **564C - M SHAPE / SURF DISCIPLINE**

### **564C.01 - START M SHAPE (SURF)**

The Race is 6 laps plus a start lap. The start will be explained at Drivers Briefing and will be as follows:

#### **Option 1: BEACH WET START**

1. Both Driver and Co-Driver will be out of their boat
2. The kill switch plugged in and the engine off.
3. Both hands of the Driver and Co-Driver must be on the anti-hogging rope.
4. Both feet of the Driver and Co-Driver must remain on the ground at all times up to the green flag dropping.
5. On the drop of the starter's green flag, the race will start.

6. The Driver and Co-Driver must have both feet on the floorboard of their boat before the driver can start his engine.
7. Failure to abide by any of these rules will result in a 2 point penalty deducted and being moved to the end of the grid.
8. In the event of a boat not starting, the boat must withdraw from the water before the lead boat of the starting boats complete a full lap.
9. Due to surf conditions, the start may be changed during the discipline after consultation between the O.O.D. and the Rescue Officer.

### Option 2: BEACH LE MANS

At the discretion of the O.O.D Le Mans starts maybe used whilst racing from the beach. This will depend on weather conditions and will be notified at Driver's briefing.

1. Boats must be held in a line on the water by either the Driver or the Co-Driver.
2. The boats must be at least 2 meters apart.
3. The Drivers / Co-Drivers should be lined up in such a way that they run an equal distance to their boats.
4. Kill cords must be held at full arm's length in the air by the Driver.
5. The Driver cannot start the engine until the Co-Driver is in the boat.
6. The Co-Driver cannot start the motor.
7. Motors can be started in or out of gear.
8. Any team jumping the start by starting their engine before the Co-Driver is in the boat and does not have their feet on the floorboards will be moved to the end of the grid and given a 2 point penalty.
9. A boat handler is permitted to assist with the holding of the boat in difficult conditions at the O.O.D discretions.
10. In the event of a boat not starting the boat must withdraw from the water before the lead boat of the starting boats complete a full lap.
11. The team can be disqualified if the assistant is still in the water when the first of the leading boats rounds the start/finish buoy for the first time.

### Option 3: DEEP WATER STARTS

1. Muster area will be defined either in race instructions or explained at the Drivers Briefing.
2. Two minutes before the start of the race the start boat will raise and continue to display a 'Yellow Flag'.
3. The boats must proceed to line up side by side.
4. The start boat will then proceed across in front of the fleet and then returns back across the front of the fleet.
5. When the Start boat has crossed the fleet for the second time it will turn to face the racing line.
6. At the start the boats must keep 20m behind.
7. The yellow flag will go down and the green raised. This will indicate the start of the race.

### 564C.02 - START LINE

Any Driver not on the start line when the green flag is raised may not start that heat or any re-start of that heat. Any Driver that fails to start when the green flag is dropped may only enter the racecourse when it is safe to do so. This is only allowed if the leading boat has not completed one lap. One back-up crew per team is allowed to assist at the start provided he is positioned opposite the Driver at the start with the O.O.D's permission. Only Drivers that were on the start line and even if they failed to start they can all still take part in any restart of that heat. Any Driver or Co-Driver jumping the start either by starting his engine early or not observing the feet on the ground rule, will receive a two point penalty deducted and be moved to the lower end of the grid. A second offence will mean disqualification from that heat.

### **564C.03 - RESTARTS (SEE ALSO WET DRIVER RULE 564B.02)**

Definitions: Re-start refers to re starting the race prior to the heat going live and goes back to the original starting grid of that heat. Re-run is once the heat has gone live. Re-run of a heat/final will be done either with a pace boat, all boats must muster at the area of buoy 2 (second turn buoy) and a green flag will be used, all boats must keep their positions as per the previous lap and follow each other closely. Boats are not allowed to overtake or change positions until the green flag is dropped. The official will monitor grid positions prior to the re-run. Any Driver changing positions during the run up to the starter or when under starter's orders will be given a 2 (two) point penalty or from the beach if the water is in good condition and a green flag will be used. All boats must keep their grid positions as per the previous lap. The official will monitor grid positions prior to the re-run. Any accumulative penalties will be carried over into any Re-starts / Re-runs. Laps will be reduced from 9 to 6 to 4 respectively.

1. Re-start refers to re starting the race as the red flag has been raised before the last boat has passed the start/finish line.
2. The re start goes back to the original starting grid of that heat including the start lap.
3. Any accumulative penalties will be carried over into any Re-start.
4. No re-fuelling, or changing set-up and propellers can take place on a re-run or re-start.
5. Boats that are on the starting grid when the green flag drops can join a re-start 564C.04 RE-RUN

### **564C.04 - RE-RUN**

Re-run: Once the heat has gone live.

1. Re-run of a heat/final can take place from the beach or in deep water.
2. Deep water Re-Run: will be done with a pace boat.
  - a) All boats must muster at the area of buoy 1 – see diagram G.
  - b) A green flag will be used to start the re-run from the pace boat.
  - c) All boats must keep their positions as per the previous lap and follow each other closely.
  - d) Boats are not allowed to overtake or change positions until the green flag is dropped.
  - e) Any Driver changing positions during the run up to the starter or when under starter's orders will be given a deduction of a 2 (two) point penalty
  - f) On a deep water start the chicane is missed out, unless otherwise directed at Drivers Briefing from the OOD.
3. Beach Re-Run: if the water conditions allow, using a green flag to start. All boats must keep their grid positions as per the previous lap. The procedure will be the same as a standard start but without the start lap.
4. The officials will monitor grid positions prior to the re-run.
5. Any accumulative penalties will be carried over into any Re-starts / Re-runs.
6. Laps will be reduced from 9 to 6 to 4 to 2 respectively, unless the OOD reduces laps on the grounds of safety.
7. No re-fuelling, or changing set-up and propellers can take place on a re-run or re-start.
8. Boats that do not start the race cannot join a re-run

## **564D - CIRCUIT DISCIPLINE**

### **564D.01 - START: CIRCUIT.**

The race is 6 (Six) laps plus a start lap (part of the long lap), followed by a short lap which is the first of the 6 (Six) laps, you cannot use either of these laps, nor the last lap as an equalising lap. The start, all Drivers must keep their line, maintaining their lane to and through the first turn. Drivers must not change lanes in front or behind other Drivers until they have passed and rounded the first buoy, or they will receive 2 (two) penalty points or be disqualified from that heat by the O.O.D.

## 564D.02 - FLAG OR JETTY START FROM PONTOON. CIRCUIT

Starts will utilise two flags system with both Drivers and Co-Drivers in their boats. Both flags are raised and on dropping the first flag, the engine can be started in neutral. On dropping the second flag, forward gear may be engaged and the race starts. All drivers must complete a "part of a long lap" as the start lap, followed by a short lap as the first of the the 6 (six) lap heats or 9 (nine) lap final. This does not count as one of the compulsory equaliser laps. If a boat jumps the start for the first time, a two point penalty deduction will be given and moves to the end of the pontoon. If the same boat jumps the start again, they will be disqualified from that heat. If another different boat also jumps the start after a previous jumped start, that boat will then be moved to the end of the grid next to the first offender.

## 564D.03 - EQUALISER LAPS

1. A 6 lap heat - 1 lap of the equalizer circuit must be taken between lap 2 and 5 - Failure to do the equalizing lap will result in disqualification from that heat.
2. A 9 Lap Final heat - 2 laps of the equalizer circuit between lap 2 and 8. Failure to do 2 equalizing laps will result in disqualification from that heat.
3. Equalizer laps must be completed after the first lap and before the start of the final lap. If the equalizer lap are taken on the 1st or last lap a 3-point penalty will apply.
4. If the laps are reduced to 6 or 4 only 1 equalizing lap is required.
5. Boats taking extra equalizer laps within the permitted laps will not be penalised.

## 564D.04 - RESTARTS

Return to the Start line and resume the original grid positions for a restart procedure unless

1. Re-start refers to re starting the race as the red flag has been raised before the last boat has passed the start/finish line.
2. The re start goes back to the original starting grid of that heat including the start lap.
3. Any accumulative penalties will be carried over into any Re-start.
4. No re-fuelling, or changing set-up and propellers can take place on a re-run or re-start.
5. Only the boats that are on the starting grid when the green flag drops can join a re-start. The boat causing the stoppage doesn't score or go into any restart.

## 564D.05 - RE-RUN

Return to the Start line and resume the original grid positions for a restart procedure unless, If more than 2/3 of the race has been completed (full laps rounded up) and all boats have completed ALL their equalizer laps, by all the boats running, there will be no Re-run and the results will be taken in the order that the boats last passed the finishing buoy/line. The boat causing the stoppage doesn't score or go into any re-run.

## **564E - LONGHAUL DISCIPLINE**

### 564E.01 - TIMES

All Longhaul events will be run on timing.

### 564E.02 - LONGHAUL STARTS

Dependent on the discipline (Inland, Offshore or Ultra) the start procedure can be Surf (564C), Circuit (564D) or Deep water starts. This needs to be clarified by the O.O.D at Drivers Briefing.

## DEEP WATER STARTS

Muster area will be defined in race instructions and explained at the drivers briefing, two minutes before the start of the race the start boat will raise and continue to display a 'Yellow Flag', the boats must proceed to line up side by side. The start boat will then proceed across in front of the fleet and then returns back across the front of the fleet; when the start boat has crossed the fleet for the second time it will turn to face the racing line, the yellow flag will go down and the green raised:

1. Muster area will be defined either in race instructions or explained at the Drivers Briefing.
2. Two minutes before the start of the race the start boat will raise and continue to display a 'Yellow Flag'.
3. The boats must proceed to line up side by side.
4. The start boat will then proceed across in front of the fleet and then returns back across the front of the fleet.
5. When the Start boat has crossed the fleet for the second time it will turn to face the racing line.
6. At the start the boats must keep 20m behind.
7. The yellow flag will go down and the green raised. This will indicate the start of the race.

## 564E.03 - SAFETY EQUIPMENT

In a Longhaul event the following safety equipment is the minimum requirement and must be carried at all times. All equipment should be clearly marked with the boat number. The advance race instructions must state what equipment is required dependent on the type of Longhaul including the option to allow props and other maintenance equipment on the boat. All equipment including water must come back complete.

Circuit Longhauls: Toolkit – flip kit with a minimum of: (all to be kept in a dry sealed container).

1. Easy start spray (or similar product)
2. Number 7 flexible socket
3. 3 x dry spark plugs
4. Spark plug spanner
5. Phillips screw driver
6. First Aid kit
7. Paddles x 2 (two) attached to the boat
8. Orange flag min 0.6 x 0.4 m and means of hoisting to indicate retirement
9. VHF radio or mobile phone in waterproof case – fully charged
10. Emergency water 2 x 1lt and 2 x energy bars (glucose or similar), these must come back still sealed and not opened – they are only as an emergency.

Ultra Longhauls: The organizers may require competitors to carry the above plus any of the following:

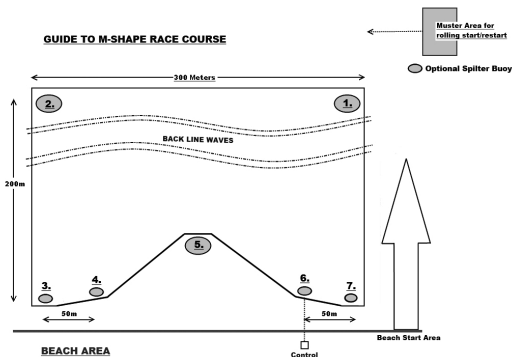
1. Pencil flares x 6 (in date)
2. 1 m x 3 m ID sheet for boats whose pontoons are not red, yellow or orange in colour,
3. Anchor 1.5 kg with chain 2 m (min 4 mm thick),
4. anchor rope x 30 m,
5. a drogue anchor,
6. space blankets x 2,
7. 1000ft flares x 2.

## 564E.04 - BEACH STOPS

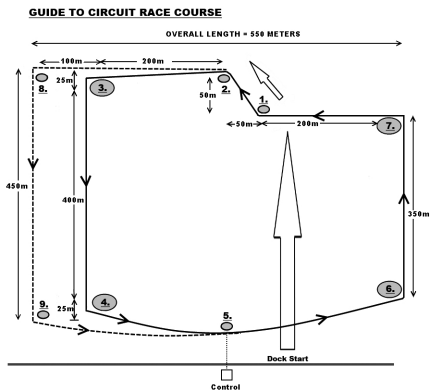
Not doing the required number of beach stops will result in disqualification. Boats are to beach as per the O.O.D instructions at Drivers Briefing. 'High-speed' drops are not allowed onto the beach; a 10 minute penalty can be given by the O.O.D if team is deemed dangerous. At all beach stops the motor must be shut-down and the boat must remain in the waterline, the Co-Driver must not leave the boat till the engine must be killed until such time that the Co-Driver has returned. Not shutting-down the engine at beach stops will result in a 10 minute time penalty. The Co- Driver must leave and enter via the side of the boat only, entry or exit via the stern or bow of the boat will result in a 10 minute penalty. Back-up crews may assist at the discretion of the O.O.D. No interference by any competitor or his back-up crew with another competitor on a beach stop is allowed. Any obstruction of any kind will be penalised with a disqualification from the race.

1. Not doing the required number of beach stops will result in disqualification.
2. Boats are to beach as per the O.O.D instructions at Drivers Briefing. 'High-speed' drops are not allowed onto the beach; a 2-point penalty can be given by the O.O.D.
3. At all beach stops the motor must be shut-down and the boat must remain in the waterline, the Co-Driver must not leave the boat until the engine has been killed, and must not be started until such time that the Co-Driver has returned and in the boat. Not shutting-down the engine at beach stops will result in a 2-point penalty.
4. The Co-Driver must leave and enter via the side of the boat only, entry or exit via the stern or bow of the boat will result in a 2-point penalty.
5. A single back-up crew may assist with handing the spare fuel tank to the driver and taking away the empty tank but they must not assist with connecting or assisting with the boat / engine in any other way. The O.O.D may allow further assistance with holding the boat in rough/ windy conditions, this will be agreed at Drivers Briefing.
6. No interference by any competitor or his back-up crew with another competitor on a beach stop is allowed. Any obstruction of any kind will be penalised with a disqualification from the race.

DIAGRAM G: Guide to Surf Course Layout



## DIAGRAM H: Guide to Circuit Course Layout

**565 - RIGID INFLATABLE BOATS (PR) (PF)****566 - CLASSES**

PR 550 cylinder capacity of the motor to 550 cc incl.

PR 700 cylinder capacity of the motor to 725 cc incl.

PR 750 cylinder capacity of the motor from 551 cc to 770 cc incl. PR

850 cylinder capacity of the motor from 771 cc to 870 cc incl. PR

1000 cylinder capacity of the motor from 871 cc to 1060 cc incl.

PR 1500 cylinder capacity of the motor from 1061 cc to 1550 cc incl.

PR 2000 cylinder capacity of the motor from 1551 cc to 2050 cc incl.

PR 3000 cylinder capacity of the motor from 2051 c to 3150 cc incl.

A free category (e.g. catamaran) is established in the following classes: PF

550 cylinder capacity of the motor to 550 cc inclusive

PF 750 cylinder capacity of the motor from 551 cc to 750 cc incl.

PF 850 cylinder capacity of the motor from 751 cc to 870 cc incl.

These classes are for low emission engines complying with 2006 EPA rules (as per homologation sheet):

PR 4 Advertised horsepower of the engine not more than 60.

PR 3 Advertised horsepower of the engine not more than 140.

PR 2 Advertised horsepower of the engine not more than 200.

PR 1 Advertised horsepower of the engine more than 200.

## **567 - HULL (PR CLASSES ONLY)**

### **567.01**

The bottom of the hull may be convex, but not be concave.

Hull consists of rigid centre section and pneumatic tubes.

For the Endurance Pneumatics Championships materials of the rigid centre section, keel, transom etc. are free.

Pneumatic tubes must be inflated with atmospheric air and made with fabrics with plastometers and elastometers in two or more independent compartments.

### **567.02**

To reach the minimum weight, fixed ballast is allowed, and must be permanent rigid and fixed to the inside of the hull.

It should not exceed 10 percent of the weight of the hull without ballast.

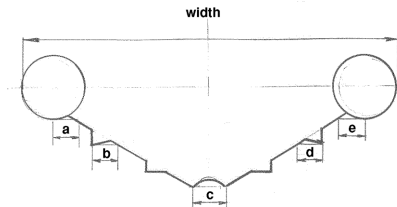
### **567.03**

Only monohull form is permitted. The boat shall not present in any of its lines any configuration which could contribute to aerodynamic lift.

Transverse steps, tunnels, hydrofoils or devices which add air pressure under the hull, are prohibited, except that protruding strips or redans parallel to the fore and aft line of the keel are permitted providing that in any channels, etc. so produced the horizontal measurements, of such openings with the boat on an even keel, do not add up be a total of more than 10% of the width of the hull in any transverse section for PR 850 and below and 20 % for PR 1000 and up. This includes the tunnels of the joint between the tubes and the rigid hull for PR 850 and below.

For circuit endurance championships transverse sections should, from centerline, have positive angles up to sections maximum beam, except in the following two cases:

- Each spray deflector may have a concave surface with a horizontal width from the hull to the outside of the spray deflector of no more than 8 % of the hull's bottom-section-beam.
- Each spray deflector must not have a total downward angle exceeding 20 degrees.
- Transverse redans are permitted.
- Steps which are swept may have a distance of no more than 25% of Measured Length of hull.



**For PR 550, 700, 750, 850 :  $a+b+c+d+e < 10\%$  of the width**  
**For PR 1000, 1500, 2000, 3000 :  $b+c+d < 20\%$  of the width**



**567.04**

Steering by a steering wheel is mandatory, the control handle for reverse gear must be within hand reach of the driver.

Kind, number and position of seats are free.

Restraint system (driver harness) is prohibited.

The use of any device or part of the boat construction, which is blocking the driver from freely getting out of his sitting position, without removing the above-mentioned device or part, is prohibited.

**567.05**

Any device to produce a sudden braking effect, causing excessive water spray, reducing visibility, is prohibited.

**567.06 - MINIMUM DIMENSIONS**

Class	Weight	Length	Width	Amidship Min. Tube Diameter
PR,PF550	200 kg	3.50 m	1.50 m	0.25 m
PR700	280 kg	3.70 m	1.60 m	0.25 m
PR,PF750	350 kg	4.00 m	1.70 m	0.30 m
PR,PF850	380 kg	4.10 m	1.80 m	0.35 m
PR1000	470 kg	4.20 m	1.80 m	0.35 m
PR1500	520 kg	5.00 m	1.80 m	0.35 m
PR2000	600 kg	5.30 m	1.80 m	0.40 m
PR3000	680 kg	5.60 m	2.00 m	0.40 m

- The minimum weights mentioned here above are the weight of a complete rig weighed directly after the race without driver, residual water but including the residual fuel.
- Measurements are taken while the boat is ashore.

The length must be measured as the overall length of the between perpendiculars at the foremost part of the boat including the pneumatic tubes to the utmost part of the boat.

Any extending parts, rubbing starches, fenders, stabilising and trim tabs and rudder are not to be included.

The width of the boat is measured at the widest part of the boat.

- The tube diameter will be measured amidships of the boat. The diameter in the bow should be at least 0.25 m in classes PR700 up. PR550 class can go down to 0.20 m.

**568 - MACHINERY****568.01**

Only one propulsion motor is allowed and all of the propulsive effort shall be exerted through the water.

An outboard is a mechanical propulsion assembly which can be removed from the boat in a single unit, complete with its transmission and which does not transmit its power through the hull at any point.

The motor thus removed and placed ashore must be capable of being started and run, fed by its fuel tank.

The mounting supports fixed to the boat, the control levers, the tachometer with its connections, the battery with its conductors and the fuel tank and fuel lines do not form part of the motor unit.

The attachment angle and the height of the motor must remain fixed while the boat is under way.

For PR,PF 550 the centre of the propeller shaft (measured at the centre point of the rear end of the propeller shaft) shall not be above the bottom of the boat measured at the lowest point of the transom. This dimension will be checked in the "as raced" condition.

### 568.02

The outboard motor must be able to function at reduced speed.

### 568.03

When the motor is in the water, the cooling water must be fed by the water circulation pump.

### 568.04

A gear changing system giving forward, neutral and astern movement is compulsory.

The control handle for reverse gear must be within hand reach of driver.

The casing of the underwater unit (gear case) is free. All internal parts referred to on the homologation file must be maintained. Should the homologation provide for it, the exhaust will be a propeller exhaust.

### 568.05

An electric or manual starter to assure a quick and easy start without complications must be fitted.

It must be used as it was supplied by the manufacturer.

## 568.10 - SOLE MODIFICATIONS ALLOWED

Only the following modifications are allowed:

1. All nuts, screws, washers and bolts may be replaced.
2. The original propeller may be replaced by another in accordance with 504.13. For Endurance Pneumatics Championships the original propeller may be replaced by another. Gearcases with exhaust system can use propellers not equipped with an exhaust tube.
3. The trim tab may be altered or removed to accommodate a propeller.
4. The cooling system must be provided by the water pump.
5. Thermostats and pressure valves of the cooling system may be removed.
6. The steering mechanism may be altered. If the original steering bar is removed or new ones are installed, any openings created must be sealed to prevent the motor from pulling in additional air.
7. The dampers (shock absorbers) may be altered or removed.
8. The rubber mounts of the motor may be altered, removed or replaced.
9. Revolution counters, water temperature gauges, water pressure gauges and similar instruments, can be installed.
10. Revolution limiters may be removed.
11. The gear interlock device on the starter may be removed.
12. Spark plugs are free.
13. Original carburettor jets may be replaced for another size.
14. Springs may be added to the throttle lever of the carburettors.

15. Re-boring is allowed, but only pistons supplied by the manufacturer of the motor may be used within the cc-limit of the class.
16. A part which is dimensioned in the homologation sheet may be machined for the purpose of reaching that specific measure;
17. A part may be machined to attain the weight quoted in the homologation sheet without altering other criteria given for the part in question. It is not allowed to change the flywheel but balancing machining is allowed if the dimensions and weights provided for on the homologation sheet are respected;
18. Measurements not quoted in the homologation sheet shall only be checked by visual comparison with standard parts. As the actual manufacturing tolerances are not published, small differences between the inspected part and the reference part must be accepted.
19. No parts may be added to the motor unless specified in this rule.
20. The fuel connector in the lower cover may be removed and the fuel hose from the fuel tank connected directly to the fuel pump. If this is done the opening left after the connector and around the fuel hose must be sealed to prevent extra air entering inside the cover.
21. Electric fuel pumps may be added provided the fuel still runs through the original fuel system and no parts are removed or blocked off.
22. It is allowed to extend the starter cord of a rewind starter so that the starting handle can be reached from the cockpit/drivers position.
23. Reinforcement of transom brackets is allowed.

## **569 - FUEL**

See 508.01, 508.02, 508.06, 508.07, 508.08, 508.09, 508.10, 508.11.

## **570 - BOATS WITH DIESEL MOTORS (D)**

### **571 - CLASSES**

#### **571.01**

As far as speed competitions are concerned, UIM makes no distinction between boats with gasoline or Diesel motors.

#### **571.02**

This class is not subject to any restriction as to the form of the hull, the cylinder capacity or weight, except in the "offshore" class boat q.v.

#### **571.03**

For world speed, distance and duration records, the UIM recognises a single class of boats with one or more Diesel motors.

### **572 - HULL**

#### **572.01**

The hull design is free.

## **573 - MACHINERY**

### **573.01**

Reverse gear is not compulsory.

### **573.02**

Any system of supercharging is allowed without penalisation.

### **573.03**

In normal running order: a diesel motor is defined as one in which the ignition of the fuel air mixture is caused only by the heat of the compression.

### **573.04**

The fuel used is injected into the combustion or pre combustion chamber, and not introduced into the inlet manifold together with the air for combustion.

### **573.05**

To start the motor, either before a race or after its stopping at a refuelling station, conditions contained in Articles 573.03 to 573.04 are not obligatory.

### **573.06**

Starting the motor must be done only under the direct supervision of the Technical Officer in order to have the conditions stipulated in rules 573.04 enforced at the start and during the whole event.

## **574 - FUEL**

See 508.04.

## **580 - TURBO JETS AND ROCKET PROPELLED BOATS (TR)**

## **581 - CLASSES**

### **581.01**

The two series are classified as follows:

250 kg 350 kg 500 kg 900 kg 1200 kg; over 1200 kg; and prototypes.

### **581.02**

These boats are not entitled to race, though they can attempt world speed records.

**581.03**

Turbo-jet and rocket propelled boats are accepted as international series.

**582 - HULL****582.01**

The hull design is free.

**582.02**

Weighing of the boats in running order must be made possible when a record attempt is made, by means of a balance duly certified by the appropriate Weights and Measures Authority.

**582.03**

The boats are to be weighed without driver, residual water, but with residual fuel.

**582.04**

Any device to produce a sudden braking effect, causing excessive water spray, reducing visibility, is prohibited.

**582.05**

The measurer must certify that the boat as weighed is in running order, only the addition of the driver, water, oil or fuel needed to operate is allowed.

**582.06**

A UIM registered reinforced cockpit is required. Following rules are recommended: 509.02 (FRONTAL HEAD RESTRAINT device and seat); G (canopies); 509.20 (air supply).

**583 - MACHINERY****583.01**

A turbo-jet is a rotating motor which converts directly into mechanical work, the energy produced from an expanding fluid.

**583.02**

A rocket is an motor which burns two fuels other than air. These two fuels are combined so as to obtain a mass of gas which is ejected at high speed.

**583.03**

Propulsion is according to the physical law which states that action and reaction are equal and opposite.

## **584 - FUEL**

### **584.01**

The fuel is free.

## **590 - BOATS WITH AERIAL PROPELLER (A)**

## **591 - CLASSES**

### **591.01**

The boats in this series are divided into classes as follows: 250 kg - 350 kg - 500 kg - 900 kg - 1200 kg and over 1200 kg.

## **592 - HULL**

### **592.01**

The hull design is free

### **592.02**

Weighing the boats in running order must be possible at any meeting or record course, by means of a balance duly certified by the appropriate Weights and Measures Authority.

### **592.03**

The boats are to be weighed without driver, residual water, but with residual fuel.

### **592.04**

Any device to produce a sudden braking effect, causing excessive water spray, reducing visibility, is prohibited.

### **592.05**

The measurer must certify that the boat as weighed is in running order.

## **593 - MACHINERY**

### **593.01**

The machinery is free.

## **594 - FUEL**

The fuel is free.

## **595 - ELECTRIC POWERED BOATS (E)**

### **595.01 - CLASSES**

ET-15 Battery powered 48 volt 15 kW monohull (Rule 596)  
 EH-15 Battery powered 48 volt 15 kW hydro (Rule 597)  
 Battery powered 48 volt runabout  
 Battery powered 72 volt runabout  
 Battery powered 144 volt runabout  
 Battery powered runabout with unlimited voltage  
 Battery powered 48 volt hydroplane  
 Battery powered 72 volt hydroplane  
 Battery powered 144 volt hydroplane  
 Battery powered hydroplane with unlimited voltage  
 Solar powered  
 Hybrid battery/solar powered

#### **595.01.01**

Electrically propelled boats are accepted as an international series.

### **595.02 - HULL**

#### **595.02.01 - Electric powered Runabout**

Hulls are defined as a displacement type, having no steps, no breaks in the longitudinal or transverse continuity of the immersed surface other than the keel, rubbing strips or lapstrakes of no more than 18.75 mm (0.75 in) and parallel to the centreline of the boat.

Hulls are not permitted to depend on external air pressure or design which creates a tunnel effect to aid planing.

Hulls are not required to conform to any maximum or minimum dimension restrictions.

Hulls shall not have a sponson/pod protruding from the side of the boat which interrupts the line of the side non-trip or bottom of the boat.

#### **595.02.02 - Electric hydroplane**

The hull is free. Any boat having a multiple planing surfaces or which cannot qualify as a runabout is considered a hydroplane for the purpose of these rules.

#### **595.02.03 - Hybrid solar/battery powered marathon boats**

The hull is free.

#### **595.02.04 - Solar Powered Boats**

The hull is free.

### **595.03 - MACHINERY**

#### **595.03.01 – GENERAL**

The whole of the propelling power shall be electric. Excluding noted class restrictions for motors, drive train design is unrestricted.

### **595.03.02 - ELECTRIC RUNABOUT AND HYDROPLANE**

The whole of the electrical energy shall be battery stored and carried on board and when the boat is being timed or raced over the measured distance, no additional electric power shall be generated. Power source for circuit racing shall be multiples of commercially available batteries.

### **598.03.03 - BATTERY POWERED MARATHON BOATS**

The whole of the electric energy shall be battery stored and carried on board and when the boat is being timed or raced over the measured distance, no additional power shall be generated. Power source shall be multiples of commercially available batteries.

### **595.03.04 - SOLAR POWERED**

The whole of the energy required shall be from ambient solar power excluding wind. Solar collectors designed as rigid or flexible sails are not allowed.

### **595.03.05 - HYBRID SOLAR/BATTERY POWERED**

The whole of the propulsion energy shall be battery stored and carried on board. Solar power may charge the batteries while the boat is being timed or raced over the measured distance.

## **595.04 - ELECTRIC BOAT SAFETY RULES**

### **595.04.01 - ELECTRIC BOATS**

Exposed terminals shall be adequately insulated to prevent accidental short circuits.

Batteries must be securely fastened to the boat in such manner that if the boat is in an accident, the batteries would remain in position, and be automatically disconnected from the complete system. Batteries shall have minimum an IP67 enclosure capable to withstand 6G loading.

Boats must incorporate enough flotation to ensure that, in the event of accident, the boat will float enough to be salvaged.

All electric boats in competition must be equipped with a physical disconnect of both leads. The purpose of the disconnect is to stop the motor, disable the electric system and limit power to safe levels in the event of an accident.

The disconnect must consist of a plug and tether combination. The plug fits an in-line receptacle completing the electrical circuit and allowing it to be energised. The tether must be two metres or less in length and made of or attached to the plug by material not subject to heat damage such as melting or becoming brittle.

All safety tethers must be securely attached to the driver at all times whilst the boat and the driver are under way.

At any time an electric boat is launched, recovered, disabled on the course or is under tow, the disconnect plug shall be removed from the in-line receptacle.

A caution decal must be affixed in the vicinity of the disconnect receptacle, and to the bottom or non-trip at the same approximate station line. Its purpose is to warn rescuers against handling the boat at that point and possibly completing the electrical circuit.

All exposed drives and drive trains must be adequately covered or shielded with appropriate guards or covers.

Commutator shielding is recommended in all electric boats.

Protective clothing must be worn by all drivers participating in electric events.

### **595.04.02 - ELECTRIC BOAT RACING RULES**

Starts must be dead motor starts.

Drivers must draw for lane positions.

Classes and hulls shall be in conformance with class rules.



Electric boat drivers who's boats are not on plane by the time the lead boat reaches a predetermined point must move off course and stop. The shutdown point will be determined by the drivers prior to the drivers meeting. Failure of a driver complying with this rule will result in a one race suspension.

### **595.04.03 - ELECTRIC BOAT COCKPIT RULES**

Electric powered boats with a power source greater than 72 volts must incorporate a safety cockpit/driver restraint system according to the 509 rules. Additionally, any electric powered boat incorporating a safety cockpit/driver restraint system must include an automatic electric system – battery disconnect to isolate the batteries from the rest of the system upon inversion or immersion of the boat.

## **596 – ELECTRIC MONOHULL OUTBOARDS (ET)**

General: The purpose is to limit this class to simple monohulls easily built by an amateur or readily available commercially, each fitted with one single electric motor and batteries.

### **596.01 – CLASSES**

ET-15 Battery powered 15 kW monohull

### **596.02 – HULL**

Only monohull form is permitted.

ET-15 hulls must confirm same rules as per rule 550 for monohull GT-15 class boat hulls.

### **596.03 – MACHINERY**

- 596.03.01 Maximum battery nominal voltage 800 V (rechargeable).
- 596.03.02 Maximum engine power 15 kW as advertised.
- 596.03.03 For ET-15 midsection and lower unit for homologated engine for GT-30 is allowed, only.
- 596.03.04 For ET-15 engine cover as per homologated engine midsection in use .
- 596.03.05 Propeller is free.
- 596.03.06 Water pump may be removed.
- 596.03.07 Gear ratio in lower unit is free.
- 596.03.08 Maximum power draw from battery is 18kW. Organisers may fit a data logger at the battery.

### **596.04 – ELECTRIC SAFETY**

- 596.4.01 See rule 595.04.01
- 596.4.02 Boat must also incorporate an automatic battery disconnect.

## **597 – ELECTRIC HYDRO OUTBOARDS (EH)**

General: The purpose is to limit this class to simple hydro hulls easily built by an amateur or readily available commercially, each fitted with one single electrical motor and batteries. These rules are not for international titled races until a control (over the power of the motor) unit is homologated by the UIM

### **597.01 – CLASSES**

EH-15 Battery powered 48 volt 15 kW hydro hull.

## 597.02 – HULL

Only hydroplane hull form is permitted. EH-15 hulls must confirm same rules as per rule 522 for F-125 and OSY-400 class boat hulls.

## 597.03 – MACHINERY

- 597.3.01 Maximum battery nominal voltage 48 V (rechargeable).
- 597.3.02 Maximum engine power 15 kW as advertised.
- 597.3.03 Midsection and lower unit are free.
- 597.3.04 Propeller is free.

## 597.04 – ELECTRIC SAFETY

- 597.4.01 See rule 595.04.01
- 597.4.02 Boat must also incorporate an automatic battery disconnect.

## **600 - RECORDS AND PERFORMANCES**

### **600.01 - GENERAL**

All record trials and their control are submitted to the following rules.

The record belongs personally to the driver who has established or beaten it. The record is entered under the name and nationality of the driver.

Any race against the clock, and called kilometre or mile trials or any similar name is prohibited if not conducted in accordance with these rules.

Combining speed records with distance records is not allowed.

No direct or indirect aid is to be provided to the driver/team who attempts a record while underway.

### **600.02**

World speed records, hour records, distance records and competition records are all records open to all boats and aquabikes of international classes adopted by UIM.

### **600.03**

National records recognised by UIM are the records established by boats of national classes duly recognised by the national authority (the rules of which have been approved by UIM). The Certificate differs from those issued for World Records.

### **600.04**

The World's Unrestricted Water Speed Record is awarded to the fastest boat in the world piloted by a driver, irrespective of the class of boat. This record is established in conformity with UIM rules, including a UIM registered reinforced cockpit. The registration of the cockpit is required to satisfy the following:

- 1) The cockpit in the hull attempting the World Record shall be registered as described by the UIM registration and the following requirements.
- 2) The cockpit builder shall be a registered UIM cockpit builder.
- 3) Means shall be provided by the design to reduce the crash g loads imposed on the Driver.
- 4) The cockpit should be equipped with a safety seat. Safety restraint (6 or 7 points) should be attached to the Driver's safety seat.
- 5) As part of the registration process, the following analysis shall be submitted for review:
  - a) Engineering analysis of the cockpit structure: this analysis will use the loads that would exist from the pressures resulting from the projected speed of the hull, assumed entry angles, plus a safety factor and show that the integrity of the cockpit can be maintained.
  - b) Engineering analysis of the Driver safety: this analysis will use the loads that would exist from the pressures resulting from the projected speed of the hull, assumed entry angles, plus a safety factor and show that the crash g loads imposed on the Driver are reduced.
  - c) Structural analysis of the shell, windshield, roll cage (if applicable) and attachment to the hull.
- 6) As part of the certification process, laminate samples representing the design/build required by the registration process (cockpit, shell and their junction) will be supplied for bend testing at load deflection values consistent with the analytical applied crash loads. These samples will be tested in accordance with the UIM cockpit test standard with the appropriate loading and deflection requirements consistent with the structural analysis accomplished in 5) above.  
A World record will not be approved without a cockpit registration which successfully satisfies these requirements.

## 600.05 - ELECTRIC BOAT RECORDS RULES

Power source for water speed record trials shall be multiples of commercially available batteries of any type. Motors are restricted to direct current (dc) only.

Boats may be towed to an on-course starting point, but may not be towed to achieve a planning attitude. Any such assistance will result in the disqualification of the offending boat.

Once at the starting point, all tenders and assisting craft must be removed to positions away from the racing line.

Recharging or replacement of batteries between initial and return runs while attempting a record is not permitted.

The UIM will recognize the Ultimate World Electric Boat Speed Record, set according to the relevant UIM Rules,

Irrespective of its Class listed in Rule **595.01**.

## 601 - CLASSES ELIGIBLE FOR RECORDS

### 601.01

World records may be attempted with the following craft:

- All UIM series and classes;
- American Powerboat Association classes;
- Prototypes.

For classes requiring a UIM or APBA registered cockpit and where the existing record exceeds 150 mph, additional requirements will apply. These requirements are the following:

The registration of the cockpit is required to satisfy the following:

The cockpit in the hull attempting the World Record shall be registered as described by the UIM registration process and the following.

The cockpit builder shall be a registered UIM cockpit builder.

As part of the registration process, the engineering analysis of the cockpit structure shall be submitted for review.

This analysis will use the loads that would exist from the pressures resulting from the projected speed of the hull, entry angles, plus a safety factor and show that the integrity of the cockpit can be maintained. The analysis also shall include the structural analysis of the shell, windshield, roll cage (if applicable) and attachment to the hull.

As part of the certification process, laminate samples representing the design/build required by the registration process will be supplied (cockpit, shell and their junction) for bend testing at load deflection values consistent with the analytical applied crash loads. These samples will be tested in accordance with the process referenced in 509, UIM Cockpit Test Standard with appropriate loading and deflection requirements consistent with the structural analysis accomplished in 3) above.

A World Record will not be approved without a cockpit registration which successfully satisfies these requirements.

For an example of calculations that will satisfy the analysis of the shell, refer to the report to the Safety Cockpit Committee for 2013 on the UIM web site. The report is under "official forms and procedures", "Safety Cockpit".

For an example of calculations for roll cages and reinforcements that will satisfy the analysis of the primary structure of the cockpit refer to the UIM web site under "official forms and procedures", "Safety Cockpit" for "Offshore Class 3C Cockpits and Canopies".

### 601.02

A boat can establish a record in its own class only.

### 601.03 - FROZEN RECORDS

When a class is modified so as to reduce the performance of the class, for example by:

- reducing the cylinder capacity,
- restricting the tuning permitted,
- restricting fuel permitted,
- introducing a minimum weight,
- increasing the minimum weight,
- or any other means,

the records established before the modification comes into force may be frozen on the determination of the Sports Commission and a new series of records will be started.

All proposal for new rules, rule changes and UIM General Assembly minutes shall state:

- whether or not records will be frozen,
- the classes to be frozen,
- the date(s) when the classes are to be frozen.

### 601.04 - QUALIFICATION

For offshore records a boat must have completed the course, taken the chequered flag and finished first, second or third, in a UIM World or UIM Continental Championship race in the class to be attempted and after the date when the class was last frozen.

## 602 - DEFINITION OF UNITS

### 602.01 - TIME, DISTANCE AND SPEEDS

The hour is the twenty-fourth part of a terrestrial day. The symbol is letter "h". The

minute of time is the sixtieth part of one hour. The symbol is letters "mn"; The

second of time is the sixtieth part of one minute. The symbol is the letter "s".

nautical mile = nm

statute mile = st.m

kilometre = km

nautical mile per hour = knot

statute mile per hour = mph

kilometre per hour = kmh

### 602.02 - STATUTE MILE, NAUTICAL MILE AND KILOMETRE

The statute mile is an Anglo-Saxon measure.

The nautical mile is used at sea.

The knot is not a unit of length; it expresses the speed of one nautical mile per hour.

One statute mile (st.m) = 5280 feet = 0,8690 nm = 1,609.3 km

One nautical mile (nm) = 6076 feet = 1,852 km = 1,1508 st.m

One kilometre = 3280.83 feet = 1000 metres

## **604 - BASES**

### **604.01**

Records may only be established on bases recognised by National Authorities and notified to the UIM in accordance with these rules.

### **604.02**

The base is measured and certified by an official surveyor holding a certificate of competence from a recognised institute, in the presence of a delegate of the National Authority.

The base must be measured by triangulation or electronic distance measuring equipment (EDM), which must have a first class certificate delivered by an Observatory or similar authority. This certificate must not be older than two years.

The official surveyor provides a certificate in duplicate in which the strict adherence to the above requirements is certified.

The certificate is signed by the surveyor and countersigned by the delegate of the National Authority. One of the copies is for retention by the National Authority for its special national records files and the other is sent to UIM for its special world record files.

The base for a record must be a fixed base, as laid out for a national authority or must be measured for a special occasion in waters designated by the driver. It must be defined by fixed marks ashore.

### **604.03**

No distinction is made between records established on the sea, rivers or lakes. Records must not be attempted during the period between half an hour before and half an hour after a change of direction in flow of water over the course (change of tidal flow).

### **604.04**

Any expenses incurred in the laying of a temporary course are defrayed by the entrant attempting the record.

### **604.05**

For speed records there shall be only one attempt on the course at anyone time.

An attempt must not start until the director of the trial is satisfied that effective rescue boats are on the course.

## **605 - CALCULATION OF SPEED**

### **605.01**

The National Authority calculates the speed from the data provided by timekeepers. The speed is to be shown in kilometres per hour (kmh) and statute miles per hour (mph), even when the attempt takes place on a course of one nautical mile;

The duration of each run is obtained by taking the arithmetical mean of the times recorded by two sets of timing devices the mean time being given to one hundredth of a second.

Should one of the timing devices stop or one of the signals fail and only one duration be registered, this duration will be accepted.

### **605.02**

The duration so obtained serve to calculate the speed of each run. Only two decimal places are to be used.

### **605.03**

The speed of the trial will be calculated on the basis of the arithmetical mean of times registered on two consecutive runs in opposite directions, two decimal places being used.

### **605.04**

For speed records established on a distance of one nautical mile (1nm= 1.852 km = 1.1508 st.m) the following constants are to be used:

Where t is the time in seconds.

to obtain the speed in mph:  $4142.8 \div t$

to obtain the speed in kmh:  $6667.2 \div t$

## **606 - MARGIN REQUIRED**

A record will be valid only if its speed at least equals the speed of the previous record multiplied by 1.003.

## **607 - MOTORS**

### **607.01**

All accessories and/or elements required by the racing rules for each class of boat attempting to establish or improve a record must be on board during said attempt.

### **607.02**

A boat which holds two certificates for two different classes is entitled to establish world records in those two classes, but shall make two distinct trials, one for each class.

### **607.03**

Immediately after the record trial, the motor(s) or engine(s) must be sealed with a distinctive seal in the presence of the officials who have witnessed the trial.

**607.04**

Within 48 hours of the trial, the two measurers must check that the hulls, motors and equipment are in conformity with the specifications of their class, and this inspection must be carried out in the presence of the Officer of the Day or an Official specially appointed by the National Authority.

**607.05**

When attempting to break a UIM class record, the noise level of the motor shall not exceed the authorised level (rule. 505).

**607.06**

It is mandatory to perform a noise measurement during record runs. The results of the measurements must be included in the signed measurers' report, sent to UIM.

**608 - REQUEST TO ORGANISE****608.01**

All applications for records trials must be made in writing to the National Authority at least one week before the trial and must be accompanied by the fee stipulated by the National Authority.

The National Authority applies to the UIM for homologation of records.

**608.02**

Only records established under the direct control of a National Authority affiliated to UIM can be recognised.

**608.03**

Each National Authority decides on the application for records to be established on its territory. The National Authority may refuse to consider a record application but must then explain the reasons in writing.

The National Authority indicates the validity of the record permit.

**608.04**

It is the duty of the driver to accept responsibility for any safety measures deemed necessary for this attempt.

The officials will not accept any responsibility, they will only record the results and ensure that the rules are complied with.

**609 - OFFICIALS****609.01**

The National Authority shall appoint an Official Observer and other duly qualified persons to hold the official functions.

An official so nominated shall not hold any other office than that to which he was nominated. An official shall not himself establish a record.



**609.02**

The official timekeepers and officials may receive payment for their services at rates fixed by the National Authority.

**609.03**

Time keeping may only be carried out by timekeepers and officials who have been recognised and authorised by the appropriate National Authority.

The stop-watches or any other apparatus employed must have a first-class certificate delivered by an observatory or similar authority. This certificate must not be older than two years.

Each timekeeper hands to the National Authority a signed report of the record attempt, countersigned by the official observer.

**609.04**

Timing from aboard anchored boats or aboard competing boats is not allowed.

**610 - SPEED RECORDS****610.01**

There is only one world record per class. This record can be established over the nautical mile, land (statute) mile, or  $\frac{1}{4}$  statute mile or the kilometre, for aquabikes the distance may be 500 metres.

**610.02**

The course is covered once in each direction consecutively.

The course is to be marked at either end by two posts in solid material, put up on shore with approved distinguishing marks affixed to them. The two lines uniting the two pairs of posts are parallel to each other and at right angles to the line of the measured course. Steering marks may be placed wherever needed.

90° 1 mile 90°

1 kilometre

1 statute mile

**610.03**

In wide rivers and lakes, the width of the course may be marked off at each end by two buoys, moored at a distance of one hundred metres from each other. The boats must run between these buoys.

**610.04**

Timing is to be one tenth of a second up to 100 km/h. Above 100 km/h to one hundredth of a second. Timing above 100 km/h is to be accomplished by two optical scanner triggered (tripod with swivel and telescope sight), video or similar systems, one at each end of the timed distance that can determine the exact instant the front of the boat passes a line determined by the surveyed timing marks (610.02). The systems must be linked and trigger two timers (clocks). The official record time is the average of the two timers.

There must be a timekeeper and a timekeeper observer at each position. Where two timers are used at a position the time is the average of the two timers.

***OR advanced RTK (Real Time Kinematic) based GNSS (Global Navigation Satellite Systems e.g., GPS, Galileo) connected to a RTK correction authority with uncertainty (inaccuracy) less than 10 centimeters and with timing rate not less than 10 Hz. This system and method must be authorized by UIM in advance.***

The time of day of each attempt in each direction must be recorded.

The time elapsing between the two runs must not exceed 20 minutes except for jet attempts when the permitted interval is one hour.

### **610.05**

A driver may re-start an attempt because of breakdown or other reason and may stop the engine or boat between runs.

If the attempt has not been completed within four hours of a starting time fixed by the National Authority, the officer in charge may stop the trial.

## **611 - DISTANCE RECORDS**

### **611.01**

Distance records are established on a total course of twelve nautical miles for the outboard series and twenty- four nautical miles for other series, and six nautical miles for aquabikes.

### **611.02**

In distance records, the base is covered up and down successively in even numbers and the turns are not included in the distance.

The course for distance records may be:

- a course established for speed records;
- a base of three nautical miles maximum, in straight lines with buoys placed at the corners if necessary, no corner to be less than 135 degrees.

The buoys placed at the corners must always be rounded.

### **611.03**

Any base must be defined by two posts set in concrete at either end.

### **611.04**

Timing is to be to one tenth of a second.

The timing of distance records is done by a timekeeper with two timing devices at the starting line. He is assisted by two officials, one with him and one at the other end.

### **611.05**

Stopping the motor or the boat during a distance record attempt is prohibited.

## **612 - HOUR RECORDS**

### **612.01**

The following international and national records are recognised by UIM: 1, 2, 3, 4, 6, 9, 12 and 24 hours duration records for all the series recognised by UIM.

The homologation of a record of lesser duration than that applied for may be granted, but only within such limits as provided for by the above rule.

### **612.02**

The base must not exceed six nautical mile from station to station, that is to say twelve nautical miles up and down. For aquabikes only, the distance may be 3 nautical miles from station to station that is to say 6 nautical miles up and down.

### **612.03**

The base is defined by two posts set in concrete at either end.

### **612.04**

The boat may be driven by more than one driver, but their names must be filed in the record application.

### **612.05**

Repairs and adjustments which can be carried out on board may be effected on the course.

The same motor or engine and hull must be used throughout the trial.

On the other hand, repairs that cannot be effected on board and refuelling and changing of drivers must be effected at the control station and are to be supervised by an official.

### **612.06**

Any time during which a boat stops during an attempt is included in the elapsed time for the attempt.

Turns are included in the course and are consequently not excluded from the timing.

### **612.07**

Timing is carried out by one or several timekeepers with two timing devices stationed at the start. The timekeeper is assisted by two officials, one stationed with him and one stationed at the other end.

### **612.08**

A driver can claim several different hour records during one trial by selecting the best series of consecutive laps.

**612.09**

The boat must cross the finishing line at the end of the lap (the last lap) during which the record time has elapsed.

The average speed of the last lap is calculated and the distance which corresponds to the time still to be run is added to the distance covered at the end of the penultimate lap.

The result is shown as the distance covered in the record time and the average speed for that distance.

**612.10**

Example for a two hour record on a base of six nautical miles (nm), twelve nautical miles per lap:

12 nautical miles (nm) x 1.1508 = 13.81 statute miles (st.m)

boat completes 8 laps in	1h 54mn 40s	= 110.48 st.m
ninth lap completed in	13mn 50s	= 830 s
time balance	5 mn 20s	= 320 s
distance balance	= 13,81 st.m: 830x320	= 5.32 st.m
	Total distance in 2 h	= 115.80 st.m
	Average speed = 115.80 ÷ 2	= 57.90 mph

**613 - WORLD COMPETITION RECORDS****613.01**

The UIM recognises world records of 3, 5, 10 and 15 statute miles in races for all UIM circuit classes.

No other records may be established during a race.

Unlimited hydroplanes only are entitled to statute mile records established on:

- a single lap course (two laps for APBA Gold Cup races) while qualifying or racing,
- total heat average speed while racing.

**614 - PERFORMANCE CERTIFICATES****614.01**

UIM may issue Performance Certificates for the best heats made during races for the principal international trophies.

**614.02**

Application for these is to be made by the National Authority of the country where the race took place and the accuracy of the results, timing course and class is to be certified by them.

**614.03**

UIM only recognise the results which beat previous performances.

**614.04**

The amount of the fee for Performance Certificate is decided upon annually by the General Assembly.

**614.05**

UIM may issue a performance Certificate for speed trials made by boats not included in UIM classes. These trials must, however, be made in accordance with UIM rules.

UIM award Performance certificates for boats of the Production boats Series having established or broken speed, duration, distance or competition records according to the Record Rules.

**614.06**

For these performances, it is not permissible to remove any of the boat's accessories, or items of comfort, provided by the builder and these are compulsory for racing.

UIM may award Performance certificates for any of the classes, international and national, established at sea on properly measured runs.

**615 - HOMOLOGATION OF RECORDS****615.01**

Only records homologated by UIM are considered as World Records.

Only records established under the direct control of a National Authority affiliated to UIM can be recognised.

**615.02**

If a record has been established on the territory of two National Authorities, it will be entered as a record by the National Authority on whose territory the start was made.

As soon as a record trial has taken place, the National Authority communicate the results to the Secretary General of UIM by fax and confirm it by letter.

The information has no official character and is only transmitted to such National Authorities as apply for it, in order to avoid useless trials.

**615.04**

The timekeepers and measurers must complete the official UIM record application form which must be signed as correct by O.O.D. and be sent to the National Authority within three days of the trial, seven days for APBA controlled classes.

The National Authority transmits the application for homologation, together with other necessary papers, to the UIM no later than four weeks after the trial, sixteen weeks for APBA controlled classes.

**615.05**

For a request for homologation to be considered by the UIM, the National Authority must send:

- a plan of the course if not already in possession of the UIM,
- the completed official UIM application form which must include any National Authority calculations,
- a copy of the boat's measurement certificate,
- a photograph of the boat under way with the colours, inscriptions, etc. noted on the reverse ; also to be noted on the reverse, the driver's name, class and speed achieved,
- a list of the full names of the officials with, at least, the names of the Timekeepers, Measurers, Rescue Officer, O.O.D. and Observer,
- for offshore boats, a copy of the results in which the boat qualified, as per UIM rule 601.04,

- for attempts on tidal waters, the calculation stating the times of the changes of direction of water along the course (changes in tidal flow) and the source of the information,
- a cheque for the amount due

### **615.06**

The recognition fee is fixed annually by the General Assembly.

### **615.07**

Pending the official confirmation by UIM, neither the driver, builder nor any other shall publish or cause to be published, circulate or cause to be circulated, the results of the trial, until the delegate of the National Authority has given the actual results in writing, after checking the calculations in the presence of timekeepers.

Even when such authorisation has been received, results may only be published with the addition of the words "Subject to official certification by UIM" in as large and prominent type as that in which any part of the notification itself is printed.

Neglect to comply with the above regulations automatically entails the refusal to recognise the record. The National Authority have the right to penalise whoever is responsible.

### **615.08**

UIM issues annually a list of world records, changes being made known, when they occur, by means of newsletters. UIM keeps a registered list of all world records and delivers a certificate for each new record. The certificate may list all active crew members onboard when the record is established.

## **700 - ENVIRONMENT**

### **701 - NOISE LEVEL**

Every driver is responsible that his engine(s) does not exceed noise levels at all times as specified in Rule 505.

#### **NOISE CONTROL**

All race and record attempt organisers are responsible that noise control rule 505 is enforced.

### **702 - EMISSIONS**

To reduce emissions as much as possible, all drivers are recommended to use lead free petrol and biodegradable lubrication oil.

### **703 - RE-FUELLING**

Every care must be taken not to spill fuel or oil. An absorbent carpet to avoid any spillage on to the ground must be used.

## **704 - ENVIRONMENTAL CARE IN RACE AREAS**

### **704.1**

Every organiser must appoint a responsible person or persons to make necessary arrangements to control the environment of the whole race area including spectator areas.

### **704.2**

There must be large containers in the pits where waste, such as cans, containers, oil waste can be placed.

One person must be responsible for this and to authorise the proper removal after the race meeting with the Local Authorities.

## **800 - CUPS AND TROPHIES**

### **800.01 - INTERNATIONAL CUPS**

The National Authorities must send to the Secretary of the UIM a copy of their international Cup Rules, Year Books, official Statutes and other publications. These documents will be held at the disposal of all National Authorities.

### **801 - ALFRED BUYSSE TROPHY**

The Alfred Buysse Trophy is perpetual.

The present regulations may be modified by the donor and after him by the General Assembly.

The holder of the cup must insure its safe keeping for a year and return it personally to the National Authority. Two plaques, presented to winners, remain their property.

The Trophy goes to the driver who has the highest number of points from titled international meetings in the list established by the Sports Commission. The latter decides which of the classes entered will count for the competition.

Only the points obtained between 1st of November and 31st of October by the first five drivers of each competition and of which the results have been properly communicated to the Secretary of the UIM by the National Authority are taken into consideration.

The UIM Secretariat publishes the results in the first bulletin following the receipt.

The interested National Authorities must indicate at the beginning of the year, which are the meetings held in their country counting for the Buysse Trophy.

All results counting for the trophy are to be sent to the UIM Secretariat within a fortnight after each race.

### **802 - JOHN WARD TROPHY**

The Trophy created in 1925 at a worth 762 E. The funds were subscribed by several welldoers and the affiliated National Authorities.

It is attributed to the 0 500 class of racing outboards but the Council has the right to attribute the Trophy to another class subject to one year's notice.

The John Ward Trophy may be raced for only by drivers holding a driver's licence issued by their National Authority.

The John Ward Trophy is raced for annually during an international titled meeting.

There is only one race for the John Ward Trophy each year.

It is not allowed to combine this race with a cup or trophy bearing another name. However, the organisers may give cups and other prizes to the competitors.

The John Ward Trophy is perpetual. The organisers hand to the winner a cup bearing the inscription "John Ward Trophy - Anno..." as a souvenir.

Because of the fragility of the Trophy, the Union has decided not to dispatch it anymore to winners.

The race is in circuit, in two heats of 9 kilometres or 5nm each. Classification on points system as per rule 317.01 of the Racing rules. In case of a dead heat, the total elapsed times decide.

The Organising Committee must transmit the results to the Secretariat of the Union, without delay.

If the National Authority who has undertaken to organise the race cannot do so, they at once notify the Secretariat of the UIM who may then offer the organisation to another National Authority.

The Trophy remains the property of the UIM.

In case the Union is dissolved, the extraordinary General Meeting held as per statutes decides what to do with it.

Any dispute concerning the attribution of the Trophy must be placed before the UIM by the National Authority. The decision of the Union is final.



The present rules can be altered only by the General Assembly of the UIM.

The organisation of the meeting is decided by priority of the alphabetic rotation of the affiliated nations, the French names of these nations being considered to this effect.

Should a nation decline the organisation, the nation which comes next in rotation is taken into consideration.

Should a nation enter the race on the Calendar for a given year but fail to organise it, said Nation is considered as having held the race, as far as the rotation is concerned.

The attribution of the John Ward Trophy must be done under the same conditions as for the Championships.

### **803 - BOUCQUEY TROPHY**

Same rules as Buysse Trophy.

The class is 0-850 cc.

### **804 - DIETER KONIG MEMORIAL**

Will be attributed to the F.500. The three first classified at the general classification will receive respectively a golden, silver and bronze medal.

### **805 - JOHN HILL MEMORIAL**

A replica of the John Hill Memorial Trophy will be attributed each year at the last European race of the F1 World Championship. The criteria to allocate the Trophy will be "sportsmanship" and the allocation will be done by the F1 Committee. The original Trophy is kept at the UIM office.

## **900 - UIM RULES FOR RIVER MARATHON RACING**

### **900.1 - GENERAL**

1. River Marathon Race is a one day for classes: P and PR or a multiple day motor boat Race covering a predetermined distance per day with an overnight stop(s) at a designated area for refueling, repairs and rest if needed. The winner will be the boat which takes the least elapsed time in covering the total pre-established distance. The minimum length of a Marathon Race must be of 600 km.
2. International racing is open to the classes mentioned in Rule 900.15. Titles shall be given to these classes only. Other local classes can be invited by the National Authorities and or the organizers of River Marathon Races, if so, the classes and the capacity of the engines must be indicated in the Advance Program.
3. An entry fee may be set for all classes including those which may have been given a UIM international Title and must be indicated in the Advance Program.
4. An Advance Programme must be sent by the organisers of an international River Marathon Race to other National Authorities and to the UIM Office at least 90 days before the race.
5. In order to contend for the UIM awards and or trophies, and prize money, the winner of each racing class must have had to complete at least 75% of the raced legs and must have had to run at least 75% of the total distance of the raced legs. For the overall awards and prize money they must have 100% of the distance and raced legs. There will be an Overall Winner (first, second and third places), they will be the boats which start and finish all of the legs, under their own power, and they do it in the least amount of time, regardless of their class (the boat and/or the driver must not be changed).

### **900.2 - APPLICABLE RULES**

1. River Marathon Racing is governed by these rules and by UIM Circuit rule Groups 100, 200, 300 and 400.
2. In cases where these rules and the rules contained in the Circuit rule Groups are in conflict, these River Marathon rules will prevail.
3. Organisers of international races may prescribe deviations from the UIM Group 100, 200, 300 and 400 rules only when they are called for by national legislation or by safety or environmental requirements, or when the organisers deem those rules unsuitable for River Marathon Racing in general. Such deviations can, however, be applied only if they have been published in the Advance Programme.

### **900.3 - RACE OFFICIALS**

Any Race Official may bring forth any infraction of these rules to the Officer of the Day, the Race Officials are:

- (a) Officer of the Day (Race)
- (b) Deputy Officer of the Day (Race)
- (c) Medical Officer
- (d) Technical Officer(s)
- (e) Scorer and time keeper
- (f) Start and Finish Line Officials
- (g) Ramp Officials

## 900.4 - RACE COURSE

1. Race Course: are those rivers and/or waters, and/or segments thereof, between the first starting line and the last finish line as designated by the Race Committee.
2. A River Race can only be done on a rivers class I, II and III. Conditions on a river may vary from time to time during the year. In the Advance Program it must be indicated the class of the river for each of the legs of the race.
3. Race Leg are the segments of the race course between the starting line and finish line, as designated for any particular part of the course.
4. The length of the race course must be such that it can be covered in a maximum of seven days of racing, excluding possible lay days which can only be a maximum of 50% of the racing days. The minimum duration of a race is two days (for inflatable boats - one day as per rule 900.1), excluding a possible lay-day.
5. A day's race course can consist of more than one leg and it can be done in the same or different rivers. The organizers must allow sufficient time between each leg for the racers to get to the finish line, it should be proportional to the length of the leg. The allowed time must be confirmed at the driver's meeting of each particular day and/or leg. If the race course is divided into two or more legs, the distance to be raced each day must be such that it can be covered between official sunrise and sunset of the region in question.
6. The race course does not need to be registered or officially measured by the UIM.
7. A Race Leg is part of the distance to be covered in the River Marathon. A River Marathon is conformed by multiple Race Legs, they can be run on the same river on the same or different day(s) or on different rivers on different days.

The minimum distance of a Race Leg is 40 km (except for the Inflatable Boat Classes) and the maximum distance will be of 200 km. A particular day's Race Leg can be cut in a maximum of 4 sections, with up to 3 (three) time cuts. For these time cuts, the distance to be covered in a section cannot be less than 10 km. There cannot be a time cut of a day's Race Leg for the night.

The Race Legs should be run according to Rule 900. 3. 2. If for any reason the finish of a Race Leg is not done during the day it is programmed, then the Race Committee will have to determine if either the total Race Leg and/or the remaining part(s) of it will be cancelled.

If a Race Leg is being run with one or more time cuts, for scoring purposes it will be considered as one leg. If a boat gets a DNF or a DNS, the penalty time will be assessed as it was one Race Leg.

8. Refueling: it will not be allowed during the time a Race Leg is being raced. If there is a particular Race Leg which is very long and boats need to be refueled, a time cut must be programmed. This will have to be indicated in the Advance Program, as well as the refueling procedure. It will have to be stated at the day's Driver's Meeting.

Depending where the race is being held, certain environmental rules and regulations will apply.

9. Crew Assistance: during the time a Race Leg is being raced, the race boats can be assisted by their crew to make any repairs on the boat and/or engine. The Crew Assistance during the race can be prohibited and will result in a DNF, this will have to be indicated in the Advance Program, in this case the only assistance to the race boats allowed is the coincidental assistance from the spectators and/or the Official / Sweep Boats.
10. The Race Committee can postpone a day's race for 24 hours, if the weather conditions and / or river conditions are not adequate. They will have to follow procedures indicated in Rule 309.01 and 309.02.
11. Cancellation of a Leg: if a Race Leg is cancelled or part of a Racing Leg is cancelled due to safety issues, only the portions which have been raced, will be accounted for, for the total distance of the Marathon. It will be up to the Race Committee to determine if the Race Leg and/or the section which was or were cancelled, are to be run in other section of the river and/or other river and the time when it would be run. This will have to be communicated to all the Drivers and a pre-run time must be allowed.

## 900.5 - CREW

1. Any race boat crew shall be comprised of no less than 2 members, one of them must be designated as the driver in the entry form.  
The boat driver must be in possession of a current racing license issued by his National Authority.
2. All crew members full names, age and home address must be communicated to the race organisers when the boats official entry to the race is made.
3. Changes of the crew members during the race shall only be made with the explicit consent of the Race Committee except for the driver, who cannot be changed.
4. Each crew shall have one crew member designated as Captain who is responsible for the boat and all actions of its crew. All matters related to the race shall be conducted through the Captain.
5. The minimum age of a crew member is 18 years, for younger crew-members (16 years or older), they can race only with a written authorization from their parents and/or guardians.
6. The boat Drivers for the A and the UNLIMITED Racing Classes must have an Certified and/or Apportioned letter from their National Race Boat Federations, indicating that they have the racing experience, capabilities and medical condition to race in these classes. This letter will be valid for the following two years.

## 900.6 - EQUIPMENT

In order to race, each race boat must be equipped with the following:

- a) A minimum of two oars or paddles
- b) A minimum of two ropes, one measuring 12 mm (1/2 inches) in diameter and 10 m (33 ft) in length to be used for towing, another rope measuring at least 10 mm (3/8 inches) in diameter and 15 m (50 ft) in length, it must have at one end a flotation device and the other end must be fastened to the structure of the racing boat.
- c) A set of flags: red and yellow, measuring each one at least 400 x 600 mm (16 x 24 inches) and attached to a pole 800 mm (31 inches) long. No black flags should be carried in any of the race boats.
- d) An emergency first aid kit
- e) A repair kit with necessary tools
- f) Two readily accessible fire extinguishers (BC or equivalent rating) they must be mounted securely (on a strong mount) to avoid dislodging during an impact or an accident. Having a minimum capacity each of 1.00kg. It is recommended to use a permanent fire extinguisher system with the fire trigger button within the reach of the racing crew. All the fire extinguishers must have a standard approval label and/or certificate showing that it has been serviced within the last 12 months.
- g) Life jackets for all crew members conforming to minimum specifications as stipulated in Rule 205.06.
- h) Crash helmets conforming to rule 205.07, (except 205.07.01 until 1/01/2019) for all onboard crew members. Helmets should be replaced after a serious accident and if for any reason the helmet fails to pass the technical inspection.
- i) Clothing of any flammable material such as plastic or nylon, can be worn by crew members on top of the racing suit only in weather affected areas. The racing suit can be a one or two piece suit, it should be made of wool or cotton, any flame retardant material is highly recommended. Regular length pants and long sleeves are required.
- j) The use of helmet to life jacket back or side straps is highly recommended.  
Restrained drivers must use a low profile Frontal Head Restraint (FHR) that satisfies SFI 38.1 or FIA 8858 standards, as from 1<sup>st</sup> June 2019.
- k) The crew must wear eye protection during the race, it is recommended that it is in the form of shatter proof material (plastic goggles or it could be a full face protection).
- l) The use of closed fire masks (balaclavas) by the race crew is not recommended.
- m) It is recommended that any large items liable to move in a case of an impact, must be installed and/or fastened in a manner where they will not be projected to the crew and should be fastened in such a way that they can be taken in case of an emergency.

- n) The use of rear view mirrors are highly recommended. As of 2016 it will be compulsory.
- o) If the use of a Global Positioning System (GPS) is to be allowed during the race, only a small GPS (maximum of 5 inch screen / measured diagonally) can be used on the race boat. Mounted GPS must be in front of the Navigator (facing the navigator), if it is a handheld it must be under the control of the Navigator at all times. It must be indicated in the Advanced Program if the use of the GPS will be allowed during the race or not.
- p) A full time onboard breathing system is allowed for all Jet Boat Race Classes. If used, the rules in Rule 904. 2. 1 AIR SYSTEMS, apply.

## 900.7 - TECHNICAL SAFETY REGULATIONS

1. Fuel tanks must conform to the following when applicable:
  - a) Removable fuel tanks such as those used for outboards must have quick disconnect couplers to permit such tanks to be filled at a remote location, away from the boat
  - b) a fuel tank must be properly grounded. It must have a minimum 50 mm (2 inch) diameter spout to fit the fuel tender. The spout must be fixed to the boat.
  - c) fixed fuel tanks must be properly vented to the outside of the boat
  - d) all fuel tanks must be securely fastened.
2. Any water outlets exiting from the side of the boat must be directed horizontally or downward.
3. All propeller driven race boats must be equipped with a kill switch to stop the engine if the driver is separated from the boat.
4. For totally enclosed inboard engines the bilge must contain a blower or must be well ventilated.
5. It is recommended that all carburetors or induction inlets have flame arrestors, they should stay on the engine at all times when the engine is running.
6. It is recommended that all moving mechanical parts such as drive shafts, flywheels, belts, pulleys, etc., have a secure cover.
7. All Inboard engine boats and Outboard engine boats, must have a battery isolator switch. The switch should be accessible to the racing crew and must be marked by a red triangle 75 mm (3 inches) sides.
8. There should not be any sharp elements or protruding elements in the boat were the crew is seating while racing the boat, as stipulated in Rule 509.09.
9. It is recommended that the steering cables must be made of flexible stainless steel wire with a minimum diameter of 4.7 mm (3/16"). Production built rack and pinion push-pull steering systems are allowed. It is also recommended that the cables run from the steering wheel to the back, in a manner to avoid hitting the race crew if they are pulled to the back in an impact. If the steering cables are directly attached to the nozzle of the jet, the cables must run through the middle of the hull.
10. D-Shackles if used in any section of a steering system must have the original pin removed and replaced by a same size bolt. The bolt must pass through the shackle so as to enable a nylock nut to be fitted which will be further secured by a lock wire.
11. The use of bull dog clips or wire cramps is banned.

## 900.8 - INSPECTION PROCEDURES

1. Motors, hulls and compulsory equipment subject to these rules shall be inspected prior to racing and after any of the legs have been finished to assure compliance with these rules. The technical inspection shall be conducted by designated inspectors who must report compliance or non-compliance with these rules to the Technical Inspector, who will communicate the same to the O.O.D.
2. Each race boat and support boat, must go through a technical and safety inspection before the race. All equipment shall be available for inspection during the time and at the location specified for technical inspection. If any equipment is found not to be in compliance with these rules, or if the captain or driver has failed to comply with the spirit or letter of these rules, the Race Committee may rescind the entry. Correction or substitution may be permitted if made prior to the start of the race. The start of the race shall not be delayed to allow compliance.

3. The engine block may be given a unique identification mark to facilitate enforcement of Rule 900.9.13.
4. Immediately after crossing the finish line of the last leg of the race, contestants shall report with their boats and motors to the inspector at the location designated by the Race Committee. The boats and motors shall remain in the custody of the inspector(s) until dismissed. Any contestant(s) refusing to comply with the orders of the Technical Inspector or who violates the provisions of this rule, should be communicated to the O.O.D., and may be disqualified from the race by the Race Committee.
5. The Chief Inspector shall have the power, after the finish of the race, to order any contestant(s) to dismantle the motor for inspection and/ or measurement at the designated area, this should be communicated to the O.O.D.  
The Technical Inspector measures the engine capacity with a micrometer and/or gauge (if available), if the motor's capacity is on the upper limit, it will be at his discretion if the motor should or should not be dismantled. The cost of dismantling and assembling the motor should be paid by the contestant.
6. Any boat which after it has been inspected and according to its motor capacity should have raced in a bigger class, will be disqualified from the race by the Race Committee.
7. If during the technical inspection of the engine (tear down), the Technical Inspector determines that the motor is out of the specifications, the race boat and driver will be disqualified from the race and banned from any UIM sanctioned event for the following 12 months. The Organizing Committee and the UIM Commissioner will have to report in writing the findings to UIM, who will issue a sanctioning letter addressed to the driver's National Authority for the application of the sanction in the country as well.
8. After an accident all boats must be inspected and released by the Technical Official of the race. If a boat is not released it cannot continue to race.

## 900.9 - GENERAL RACING RULES

1. Definitions:
  - a) Starting Line: it is an imaginary band, approximately one meter (three feet) in width, as drawn from the starting flag person to a point across the river or water as described by the Race Director at the daily drivers meeting
    - (1) To be ahead of the starting line implies being on the leg between the starting and finish lines so designated for that leg
    - (2) To be behind the starting line implies being out of the leg designated for that day.
  - b) Staging area: that segment of the water immediately behind the starting line and continuing away from the starting line. It should be of a distance of approximately 70 meters, if the conditions of the river do not allow to have the required length, the Race Committee can modify the staging area accordingly.
  - c) Holding area: that area behind the staging area and continuing for a reasonable distance away from the staging area.
  - d) Finish line: the imaginary band, approximately one meter (three feet) in width, drawn from the finish flag person to a point across and approximately perpendicular to the bank of the water. The finish line will be described at the drivers' meeting prior to the beginning of each leg.
  - e) Under its own power: The boat is in motion and not assisted by any other powered vehicle or craft. When starting a leg it cannot be done by the motion generated from the water current and/or the rowing action of the crew. On finishing a leg it can be done by motion generated from the water current and / or the rowing action of the crew considering that the boat has run all of the leg without any external assistance. This rule cannot be changed in the Advance Program.
  - f) Under the control of its own crew: The crew is deemed to be able to control the destiny of its own boat.
  - g) Wilfully: a boat is under its own power and under the control of its crew.
  - h) Being in tow (taking a tow): the boat is put into, or is in motion with the assistance (in any way) of, another powered vehicle or craft.
  - i) Allowed starting period: that period of time between a boat's designated starting time and the official closing of the starting line.

- j) Pit area: that area of the parking lot designated by the Race Committee for parking of racing boats, trailers and support vehicles. Each entrant will have a designated parking space for one boat and trailer in addition to an adjacent space for a support vehicle. Also, any area where boats are parked between legs of the race will be considered a pit area.
  - k) Long block: the engine block, heads, valve train, crankshaft, rods, pistons, camshaft, and timing drive assembly.
2. A Drivers' Meeting will be held prior to each race leg of the race at the indicated time.

If the Race Leg has any time cuts, it will not be necessary to have a Driver's Meeting before each section, unless the Race Committee determines to be necessary, this will have to be indicated at the initial day's Driver's Meeting. Where the meeting area is small in its capacity, only the driver and navigator of each race boat entered in the next leg are allowed to attend the Drivers' Meeting. A roll call will be held at the beginning of the meeting, the name of each raced boat driver will be called out and a 15 minute penalty assessed for drivers being absent when their name is called. If a race boat driver is absent by Force Majeure the penalty will be reviewed by the Race Committee.

- 3. The life jacket and helmet must be worn by everyone in a race boat at all time while the boat is in motion under its own power, this implies during racing, testing or tuning. Violation of this rule will result in assessment of a 15 minute penalty.
- 4. Drinking alcoholic beverages or using intoxicating drugs by any race boat or safety boat drivers or race official prior and during the event hours is strictly prohibited. No boat (race or safety) driver shall drive a boat if alcoholic beverages or intoxicating drugs have been consumed. Violation of this rule will result in total disqualification for the drivers or suspension of official duties for the race official.
- 5. The use of offensive language by a crew member towards any other person or crew member or race officials will not be tolerated. Violation of this rule will result in assessment of a minimum ten minute penalty.
- 6. Intentionally causing damage to another boat or intentionally causing bodily harm to a crew member of another boat will not be tolerated. Anyone failing to comply with this rule will be totally disqualified.
- 7. A crew member must obey the instructions of any Race official. Failure to do so will result up to total disqualification from the race.
- 8. The possession of firearms at any time during the event by any crew member is strictly prohibited. Violation of this rule will result in total disqualification.
- 9. No person shall provide or receive assistance from the air or by radio during the race. Failure to observe this rule will result in the contestant being disqualified for the leg. Global Positioning Systems (GPS) are allowed.
- 10. After the boat has passed inspection, the Technical Inspector may re-inspect it to insure that all of its compulsory equipment is present and technical specifications are in compliance with the rules.
- 11. Smoking is prohibited in the designated pit area and / or onboard a boat and / or in an area 3 m (15 ft ) around the boat. Violation of this rule by any crew or member of the team will result in a penalty to the race boat. This penalty will be assessed by the race officials and can be of 15 minutes to disqualification of one particular leg.
- 12. The hull shall not be replaced during the race. Failure to abide by this rule will result in total disqualification from the race.
- 13. ENGINE REPLACEMENT The organiser can decide to use Rule A or Rule B provided it is printed in the Advance Programme.

**RULE A** The engine block must not be changed during the race.

**RULE B** The complete engine can be changed once only during the race in the case of failure, provided the captain of the boat notifies the Technical Inspector who must authorize the change and inspect the engine to be replaced as well as the second one, for class homologation and give new identification numbers and / or marks. The second engine block cannot be replaced during the rest of the race. The Race Organizer may assess a penalty of up to 15 minutes for the engine change, this must be indicated in the Advance Programme.

The initial engine block cannot be rebuilt and used for the remainder of the race. Failure to observe any part of this rule will result in total disqualification from the race.

If there is no indication on the Advance Program regarding the change of engines, then rule A will apply.

14. A boat which has been disqualified for a leg, may continue in the race, for the disqualified leg it will have the same time as the boats which did not start (DNS) Rule 900.13.
15. The organizers must specify in the Advance Program if there will be fuel available for the race and if the fuel for the first leg is included, what type and / or quality of fuel and under what terms and conditions it will be supplied to the racing boats.
16. Fuel can be inspected by the Technical Inspector at any time during the race, this will be done according to the regulations and procedures indicated in Rule 508. Failure to let the fuel be inspected will result in total disqualification from the race. Regular Pump fuel refers to the fuel which anyone can buy on a regular basis in any fuel station at the race site, the octanage considered for the race, will be the highest available at these stations.
17. The race boat must have a set of race numbers on each side and one on the bow of the boat. The racing numbers size on the boat must comply with Rule 206.02. The colors can be according to this rule or they can be of another color with a contrasting surface surrounding them, or they could have an outline of at least 4 cm wide of a contrasting color.
18. Any issue not foreseen by these rules will be decided by the Race Committee, according to Rule 200.02.

## 900.10 - FLAG SIGNALS

- 1) Red Flag: raised and displayed by a safety boat or a race boat implies danger or emergency. All approaching boats must stop. It is the responsibility of a member of the safety boat, or race boat crew member if a safety boat is not present, to maintain a record of the time the boat is stopped. After stopping for a red flag, a race boat may not continue with the race until a safety boat has arrived and granted permission to continue the race even if the red flag was unjustly raised. Prior to granting permission to continue, the safety boat must record all boats' times out and forward them to the finish line officials for the leg. If a boat fails to wait for a safety boat before proceeding with the race, the time out will not be acknowledged. The boat which makes improper use of the red flag, will be disqualified from the race by the Race Committee.
- 2) Yellow Flag: A safety boat member or race boat crew may raise its yellow flag only when they have a problem, when one of the crew is in the water, or they become an obstacle in the race course and the boat prevents or endangers the safe passage of oncoming boats or endangers the life of any or all the crew members. When a yellow flag is displayed the approaching boats should proceed with caution until they pass the problem area. The improper use of the flag will result in total disqualification of the offending boat for the leg.
- 3) Black Flag: do not leave the pit area - return to the pit area. The race course is closed.  
The Black flag will be under the control of the O.O.D. Race boats are not allowed to carry one.
- 4) Green Flag: It will be raised for each boat at the starting line, 10 seconds before the starting time and lowered at the starting time. It will be raised again 10 seconds before the starting time of the following boat.
- 5) White Flag: It will be raised at the starting line, 1 (one) minute before the starting time of the first race boat of that leg and lowered 10 seconds before the starting time. For the following boats the green flag will be raised according to rule 900.10.4.
- 6) Black and White Chequered Flag: raised with the arrival of a boat at the finish line and lowered when the boat crosses the finish line.

## 900.11 - STARTING

1. A ramp official will be present at the launching site, prior to the start of the race, to assure orderly and timely launching. Each boat may be given a launch time, each boat will have five minutes to clear the ramp / launch area. Failure to do so will result in a penalty of 15 minutes. Emergency situations requiring longer times will not be subject to the penalty at the discretion of the ramp official.
2. The starting order for other than mass starts, shall be determined by drawing lots.



Subsequent starting orders for other than mass starts will be determined from the cumulative elapsed times for previous legs. The starting order will progress from the fastest time to the slowest time. The starting line officials may, at their discretion, alter the order of the start if conditions so warrant. At the starting line the numbers of the next boat to start should be displayed to the racers, the size of the numbers should be at least of 300 mm (12 inches) high and they must be black on a white surface.

3. A leg is deemed to be open to racing on completion of the drivers meeting. Thereafter, and until the leg is officially closed as per Rule 900.13.3, the leg is deemed to be open to racing.

4. All boats must be in the water and preferably behind the starting line when a leg opens to racing.

Any boat which is on the water and ahead of the starting line at this time will be deemed to be wrongfully on the leg and can be assessed a penalty of 3 minutes. In order to get behind the starting line without incurring in this penalty, such boat must proceed in accordance with Rule 900.11.12.

5. If the starting procedure is stopped for any reason, a red flag must be displayed by the Starting Officials at the Starting Line during all the time, and the Race Director must be informed.

When the race course is reopened, the racing starting procedure will be re-assumed within the next minute, and the procedure will be according to Rule 900.10.5 (a White Flag will be displayed for a minute and the last 10 seconds a Green Flag will be raised). The boat which was in the staging area last will then start, the Starting Officials will keep track of all the new starting minutes of the remaining race boats.

6. While the leg is open for racing, if for reasons beyond the control of the crew, a boat crossed the starting line, prior to its designated starting time, it will be wrongfully on the leg, the crew must raise the yellow flag, if not it will be assessed a penalty of 2 minutes. When possible the boat will have to return behind the starting line in accordance with Rule 900.10.12, in order to take his start.

7. A boat is deemed to have started a leg if it wilfully crosses the starting line from the staging area at any time after the ten (10) second flag (for its designated start) is raised and before the starting line is closed.

8. A boat will be assessed a penalty of 1 minute per second if it wilfully crosses the starting line from the staging area prior to its designated starting time.

9. If for any reason a boat will fully start on any previous minute, he will be assessed a penalty of 10 minutes per every minute that he advanced his start. In this case Rule 900.11.8 would also apply for the minute which the boat started in. For the time of the race leg, the jury will deduct the total amount of minutes which he advance his time and will add the corresponding time penalties.

10. Regardless of when a boat starts a leg, it will begin to accumulate a running time for that leg from the time that it was designated to start.

11. A boat that is unable to start at its designated starting time may remain in the staging area provided that it does not wilfully obstruct or impede a boat that is rightfully in the staging area. Failure to abide by this rule will result in assessment of a penalty of 15 minutes up to disqualification for the leg.

12. The boat that is unable to start at its designated starting time may cross the starting line from the staging area at any time within the allowed starting period provided that the ten second (green) flag has not been raised for another boat. Failure to abide by this rule will result in the assessment of a penalty of 10 minutes.

13. In order to return, or get behind the starting line when the starting line is officially open, a boat, wrongfully on a leg, must comply with the following procedures whenever applicable.

- (a) If a boat is out of sight of the starting line, it may proceed with precaution at a reasonable speed and by no means at full speed against the direction of the race, navigating in the middle of the channel, this boat must display the yellow flag at all time. Failure to comply with this regulation will result in the assessment of a penalty of 15 minutes up to disqualification for the leg.

- (b) If a boat is within sight of the staging area, it may proceed against the direction of the race (not a full speed) only when another boat is not rightfully on the segment of the leg in the direction of the staging area, the returning boat must display the yellow flag at all time. Failure to comply with this regulation will result in the assessment of a penalty of 15 minutes up to disqualification for the leg.

- (c) A boat may enter, or pass through, the staging area from ahead of the starting line only without obstruction or impeding a boat that is rightfully in the staging area and only when the ten (10) second flag is not raised. In the event of a mass start, a boat may enter, or pass through the staging area from ahead of the starting line only when there are no other boats rightfully in the staging area. Failure to comply with this rule may result in assessment of a penalty of 15 minutes up to disqualification for the leg.

14. A boat which is unable to start a leg including the last one (DNS) may continue to compete in subsequent legs. It shall be given a time for the unstarted leg equal to the slowest boat time which finished within the allowed time of his class for that leg, plus the time penalties according to the Rule 900.13.9. This rule cannot be changed in the Advance Program.
15. For the starting positions for the race boats for the first leg of the race, the positions should be assigned by draw. If the river conditions for the first leg of the race, makes it complicated for faster boats to pass slower boats, the Organizer has the option of programming a qualifying session.

If so, the qualifying session should be held on the previous day of the first day of the race, and the procedure should be indicated in the Advance Program. This particular qualifying day will not be counted as part of the race days.

## 900.12 - RACE IN PROGRESS RULES

1. Any boat that is overtaking another boat must do so in a safe and courteous manner. Maintaining when possible a safe distance between the boats.
2. Any boat that is being overtaken must give way and let the faster boat through no later than the point at which the overtaking boat is within the peripheral vision of the driver. Encumbering a faster boat is not permitted and doing so will result in the assessment of a penalty of 15 minutes up to disqualification from the race.
3. Any boat that willfully travels against the direction of the race after it has started, must do so according to Rule 900.11.13.
4. The loss of any equipment required in Rule 900.6 during a race must be reported to a finish line official for that leg, if not, a penalty of 5 minutes will be assessed.
5. A race boat might or might not be permitted to refuel on a leg which is open to racing. This should be indicated in the Advance Program, if it is not indicated, the race boats will not be permitted to refuel.
6. The crew of the boat must remain in their seats at all times during the race. It is not allowed for any member of the crew of the boat to ride on the bow of the boat at any time during the race. Failure to abide by this rule will result in assessment of a penalty of 15 minutes.
7. If a boat is either returning to the starting line area or going to the finish line it must proceed with caution and according to Rule 900.11.13, if during the process they come to a point where the racing channel is narrow, they must stop and keep clear of the racing line to allow the coming race boats to go through and to follow the race officials instructions if any at the site.
8. If a race leg is cancelled for any reason due to the actions of a racer and / or race boat, the offending race boat will receive a time penalty of 20 minutes. The offending race boat driver will not be considered for the Overall Winner Title of the race.
9. During the race it is not allowed to have any helicopter assistance of any type to any race boat Helicopter assistance should be allowed after the sweep boat has passed or in an emergency. During the race, the helicopters being operated should keep a minimum height of 75 m from the water level. If they are to follow a race boat at any time, they should do it from the sides or from the back (a minimum linear distance of 75 m from the race boat). Helicopters, are not allowed to fly in front (the bow) of the race boats. It is recommended that the landing site for the helicopters, should be at least 100 m from the start and/or finish lines. This Rule can be waived by any of the Emergency and/or First Aid helicopter units.

## 900.13 - FINISHING RULES

For the purpose of the Rules 900.12, the winner of a race class is the race boat which finishes a leg under its own power in the least amount of time.

1. A boat must cross the finish line under its own power. All the boats of a class which cross the finish line within the allowed time frame for the leg will receive their actual time. The boats of a class which cross the finish line, after it has been officially closed, shall be given a time for the leg equal to the slowest boat time of his class which finished within the allowed time for that leg, plus the time penalties according to the adjustment factors indicated in Rule 900.13.9.

This will include the DNF boats Rule 900.13.5 This rule cannot be changed in the Advance Program.

2. Once a boat has crossed the finish line, it may not re-enter an open leg, unless it is approved by race officials and it may only re-enter in order to get to the boat ramp. It will have to do it with precaution and displaying the yellow flag. By no means it should cross the river if a racing boat is approaching the finish line. Failure to comply with this regulation will result in the assessment of a penalty of 15 minutes up to disqualification for the leg.
3. The leg's starting line and finish line for each class will be closed at the time indicated at the Driver's Meeting of that day, there will be a maximum of two hours allowed after the winner of a class arrives for them to be closed. If there are two or more legs which are run in a day, the closing times will be given at the day's.
4. Driver's Meeting(s), the closing time must be calculated on the average boat speeds and leg length of the racing class (it is recommended to add up to an 80 % of the determined time). All the boats which cross the finish line after it has been officially closed will be given a time for that leg equal to the slowest boat time of his class which finished within the allowed time for that leg plus the time penalties according to the adjustment factors indicated in Rule 900.13.9., no matter how they got to the finish line by water or land. For the last leg if a boat has started the leg and was not able to finish within the time frame indicated in this rule it shall be given a time for the leg equal to the slowest boat time of his class plus the time penalties according to the adjustment factors indicated in Rule 900.13.9. This rule cannot be changed in the Advance Program
5. A boat which is unable to finish a leg (DNF) may continue to compete in subsequent legs, this boat must have started the leg under its own power and must have run at least 2 km (1.2 mi). It shall be given a time for the unfinished leg equal to the time of the slowest boat of his class which finished within the allowed time for that leg, plus the time penalties according to the adjustment factors in Rule 900.13.9. If a boat arrives to the finish line after it has been officially closed Rule 900.13.3 will apply. This rule cannot be changed in the Advance Program.
6. Official results will be determined by total elapsed time plus any time penalties incurred. They must be posted at the site and before the next day driver's meeting.
7. Immediately after finishing a leg, the crew of the boat which has been picked for inspection should make his boat available to the Chief Inspector at the designated area and will be under the Inspectors custody until inspected. Failure to comply with this regulation will result in the disqualification for the leg.
8. If for any reason in one of the classes non of the boats finishes, the leg's finish line time for that class will be the time of the winner of the next smaller class plus 20 %. If there are no other classes to get this time from, the Finish Line Officials and the Chief Scorer will determine an Estimated Time, based on the distance of that particular leg at an average speed of that class, in this case for the boats which did not finish (DNF) this leg, they will have the Estimated Time plus the time penalties according to the adjustment factors in Rule 900.13.9, for the boats which did not start (DNS) this leg, they will have the Estimated Time plus the time penalties according to the adjustment factors in Rule 900.13.9. This rule cannot be changed in the Advance Program.
9. The time which will be given to the boats which do not start (DNS) or to the boats which finish after the finish line is closed or the ones which start and not finish (DNF), will be the time of the slowest boat of their class for that leg which finished within the allowed time, plus the time penalties calculated based on the following :

#### ADJUSTMENT FACTORS

DNF DNS

1.10 1.30

#### PROCEDURE

To calculate the time penalties for a particular boat which did not start (DNS) or a boat which did not finish (DNF) will be the following: The time of the slowest boat of the class which finished within the allowed time for that particular leg must be multiplied by the corresponding factor.

## 900.14 - SUPPORT BOATS

1. The race committee shall provide sufficient boats to act as safety boats at critical locations along the race course. The safety boats shall be properly equipped to provide rescue and emergency first aid services. They will be subject to inspection by the Technical Inspector. All occupants in safety boats shall wear nationally approved type life jackets. The safety boat captain will be a Race Official. The safety boat captain and his crew must abide by the orders of the Safety Director.
2. The safety boats are not towing crafts, however, at the boat captain's discretion, he may provide a tow after the leg is closed to the racing boats, to the nearest boat ramp or either the starting or finishing lines.
3. The Race Committee shall provide a sweep boat which will have a Race Official on board.  
The sweep boat will be the last official boat to leave when the starting line is officially closed. The sweep boat captain will give directions to any race boats on the leg that are unable to continue under their own power.
4. The finish line will remain open until the sweep boat has crossed. Any race boat crossing the finish line after the sweep boat, and consequently after the leg has closed, will receive the time as if did not finish the leg DNF Rule 900.13.9 would apply.
5. The sweep boat shall be clearly identifiable.
6. The support boats of any of the race boats must pass a safety inspection as per Rule 900.8.2.
7. The support boats for the race boats, must comply with the navigation restrictions for the race. Towing will be done after the sweep boat has passed, unless authorized by the Race Committee. The allowed tow times will be indicated during the Day's Drivers Meeting.

## 900.15 - INTERNATIONAL RACING CLASSES

1. **Series:** There should be a minimum of three boats registered per class, if there are less they will move up to the next available class.
  - A) Series Inboard Engine Boats, (I); classes FX, CX, A, and Unlimited
  - B) Series Outboard Engine Boats (O); classes 2000 and 3000
  - C) Serie Inflatable Boats ( P); classes 550V, 550, 850V and 850
  - D) Series Rigid Inflatable Boats ( PR); classes as per Rule 902.3
2. Inboard Engine Boat Classes:

Classes of Inboard Racing Boats: are determined solely on cubic capacity of the engine used and are distinguished as follows:

Hull: The hull design is free but hull must be made from Aluminum, fiberglass upper decks are fine.

Length of the Hull: The minimum dimensions are 5.2 m (17 ft).An open river cockpit that meets or exceeds these specifications must be fitted to all inboard Race Boats.

The intention of these minimum specifications is to provide the best possible protection to drivers and navigators, NO guarantee is implied or stated, nor is any responsibility taken, regarding the degree of protection or safety afforded by any roll cage construction to these specifications.

### 1. ROLL CAGE SPECIFICATIONS

- All boats must have a well structured steel roll cage. Roll cage should have a minimum of two main hoops. Of these, a triangulated main hoop is required. A minimum of one hoop in front of the passengers to the dash is required. Faster boats should have an upper and lower front hoop. There should be a bar connecting the center of the front hoop to the top center of the main hoop and 2 rear arms to the gunnels or transom.
- The main hoops shall be made from 44.5mm diameter, either round chrome moly tube (SAE 4130), minimum wall thickness 2.1mm or DOM tubing (1018 to 1026) with a minimum wall thickness 2.6mm. All other braces & struts can be made out of 38.1mm diameter of the same tube type and minimum thickness.

Consideration may be given for equivalent or stronger design but must be endorsed from the organizing group prior to the race date. Aluminum is NOT permitted.

- Attaching plates shall be a minimum of 5mm thick steel. Attachment plates to be welded centrally to the hoop tubes. If the main hoops sit on chines, it will be connected to the chine by a 10 mm thick aluminum plate welded to the chine. Attaching plates are to be bolted together to the hull with 2 M10 or 3/8" bolts or 4 M8 or 5/16" bolts or 6 M6 or 1/4" bolts.
- Cockpit area of the cage must have bars forward of the driver, an inverted side escape zone, and must prevent the dash of the boat from collapsing under load.
- No equipment inside the boat may be attached to the cage structure if it compromises the roll cage integrity

#### Welding and forming:

- All joints must be fully welded by a competent welder and remain unground using the correct welding process for the material.
- Tubes cannot be flattened in order to make a joint
- The main hoops of the cage must be one piece and may not be repaired by splicing, patching, cam-shelling, etc. All other components may be repaired by splicing, patching, clam-shelling, etc. according to generally accepted aircraft repair procedures. Each splice joint shall have an insert of 6" (152mm) minimum 3"(76mm) on each side of the joint centerline with rosette welds visible
- Top corners of the main hoops shall be formed with one bend formed with a bender suitable for the material size used, and ovality distortion to be no more than the wall thickness of the tube.
- Helmet clearance should be at least 100 mm from the main hoops for the tallest crew member.
- The Advance program must state home countries minimum roll cage requirements.

## 2.2 SAFETY HARNESS (SEAT BELTS)

- A 5- or 6-point safety harness must be fitted for every crew member and be securely attached to the roll cage. They must be a motor sport type approved with a minimum of 50 mm web for all belts and shall have a quick release buckle.
- Seat belts must be within their useful life as set by the manufacturer, considering the factory life of the belts beginning upon when installed. Belts with visible wear or tear, or in poor condition will not be allowed.
- The mounting points for the seat belt shoulder straps behind each crew member must be in a way that the shoulder strap angle be no more than 25 degrees to the horizontal.
- Seat belt harness points shall be secured to the safety cage and be constructed to withstand the same force as the harness is designed for and mounted in accordance to belt manufactures specifications.
- Seat mounts should be mounted to the cage. Seats shall have side head support.

**Engine Mounts:** The engine mounts on all classes must be attached to the hull, at least on four points, unless the set up of the jet and the engine allows it to only be attached in three points closed coupled. A safety device must be installed to the engine to avoid its forward movement in a case of a front collision.

**Throttle:** The throttle pedal must be attached to the hull and must be spring loaded, so it is capable of returning to the idle position.

**Flotation:** It is recommended to put in the bow of the hull sufficient flotation material that would allow the recovery of the boat.

The engines on these class boats should be inboard, for each class there is a specific engine capacity range. All the boat must run with a propulsion of a jet pump and must not have any exposed propellers.

Classes	Capacity
FX	Up to 5740 cc
CX	Up to 6424 cc
A	Up to 7700 cc
Unlimited	Above 7701 cc
Overall	Any of the above

**Multiplication Factors:**

- Forced Induction engines or those engines using combustion supporting additives (e.g. nitrous oxide, turbo charged, etc.), will be required to multiply their engine capacity by 1.8 to obtain their racing class.
- Rotary Engines will be required to multiply their engine capacity by 1.8 and if forced induction is utilized a further 1.4 to obtain their racing class.
- Diesel engines are not subject to any multiplication factors to obtain their racing class irrespective of whether forced induction is utilized.
- Turbine engines boats are allowed, any boat with one will run in the Unlimited class.
- Two cycle engine boats will be required to multiply their engine capacity by 1.4 to obtain their racing class.

Exhaust: the use of a muffler is required. The maximum noise level allowed are 95 decibels (dB). If the local Authorities have a maximum decibel level, it will have to be indicated in the Advance Program. It will be compulsory that all boats have one at all times during practice and during the race, if the local authorities require so, this must be indicated in the advance program. For jet turbine engine boats it is not required to have engine noise reduction mufflers.

For the "FX Class" the engines allowed to race are Small Block Chevrolet.

Roll Bar : Well braced and mounted steel tube (chrome moly or aluminium tube can also be used with the minimum diameters and structure indicated previously in this rule).

Engine Type : 8 Cylinder, normally aspirated.

Engine : Chevrolet ZZ and Crate Engine with a maximum displacement of 5,740 cc. The allowed engines part numbers must be stated in the Advance Program. Repaired engines must use GM parts pertaining to that engine.

The advance program must state all current and past acceptable GM crate engine numbers.

Cylinder Bore : No overbore is allowed.

Cylinder Heads : Stock GM ZZ4 or GM ZZ5 or GM ZZ6 cast aluminium or the CT350 iron heads, no after market cylinder heads are allowed. No polishing and/or port work of any kind is allowed.

Oil pump : no dry sump or vacuum pumps are allowed.

Oil Pan, Valve Covers and fluid damper : Any type. The oil pan can be of a larger capacity.

Ignition / Distributor : Any type.

Intake Manifold : No port matching on the intake manifold is allowed.

Carburettor : Any type not exceeding 750 CFM.

Exhaust system : Any type.

Fuel : Gasoline only. The Race Organizer must indicate in the Advance Program if there are any restrictions as far as transporting large amounts of fuel in the Country where the race will be held.

Propulsion : Any type of jet drive, it can be modified.

For the "CX" Class the engines allowed to race are LS and CT Chevrolet crate engines. 6.2L (376CID)

Roll Bar: Same as for the FX Class.

Engine Type: 8 Cylinder, normally aspirated.

Engine: Chevrolet LS3 (376 ci) stock crate engine with maximum displacement of 6220 cc.

No modifications to the factory engine or its components are allowed. Repaired engines must use GM parts pertaining to that engine.

The advance program must state all current and past acceptable GM crate engine numbers.

Cylinder Bore: No overbore is allowed.

Cylinder Heads: Factory stock heads, no aftermarket or machining is allowed.

Oil Pump: No dry sump or vacuum pumps are allowed

Oil Pan, Valve Covers and Fluid Damper: Any Type: the oil pan can be of a larger capacity.

Ignition / Distributor: Any type.

Intake Manifold: No aftermarket intake manifolds are allowed. No port matching on the intake manifold is allowed.

Carburetor: Any type.

Fuel injection : Any type or fuel injection is allowed, must be fitted to a standard "factory GM manifold".

Exhaust system: Any type.

Fuel: Gasoline only. The Race Organizer must indicate in the Advance Program if there are any restrictions as far as transporting large amounts of fuel in the Country where the race will be held.

Propulsion: Any type of jet drive, it can be modified.

### 3. Outboard Engine Boats Classes

Classes of Outboard Racing Boats: are determined solely on cubic capacity of the engine used and are distinguished as follows:

Hull: The hull design for classes O 2000 and class O 3000 is open, there is no restriction.

Length of the Hull: The minimum dimension are 5.10 m (16 ft 9 in).

Racing Capsules: are not permitted

Roll Bar: Any aluminium boat must have a well structured steel chrome moly or aluminium roll bar. The minimum specifications for the chrome moly roll bar are : 3.81 cm (1 1/2") in diameter with a wall thickness of 1.65 mm (0.065"), for the aluminium roll bar are : 3.16 cm (1 5/8") in diameter with a wall thickness of 3.00 mm (0.12"). It is also recommended that the main "A" frame(s) be made of one piece and the structure of the roll bar be done with a set of triangles with front and back supports. It is also recommended that the elements of the roll bar be secured to the chines or any of the structural elements of the hull. If possible the seats and seatbelts should be attached to the roll bar cage structure. All boats must have a roll bar or a roll cage or a reinforced cockpit. The roll bar must be at least 100 mm (4") away from any side of the helmet of the racing crew when seated foam material can be used to cover this space, as stipulated in Rule 509.05.

Seats: There should be a high back seat for each member of the racing crew, securely attached to the hull. The back of the seat should support the back of the helmet. Each seat must have at least one foot rest/support.

Seat Belts: The crew of any racing boat with a roll bar, must be strapped to the seat with four point seat belt system, at all time during the race, the straps should have a minimum width of 50.8 mm (2"). Two seat belts straps should run over the waist at the height of the hips and the other two straps should run over the shoulders. It is recommended that the wear of the straps should be checked periodically. It is also recommended that an unleashed mechanism be put in so that the seat belts buckles of the driver and the navigator can be released with a simple hand movement.

Engine Mounts: The engine must be attached to the transom of the hull, at least in four points.

Engine Cover: All engines must run with their cover on.

Transmission: The transmission used is free

Throttle: The throttle pedal must be attached to the hull and must be spring loaded, so it is capable of returning to the idle position.

Flotation: It is recommended to put in the bow of the hull sufficient flotation material that would allow the recovery of the boat.

Propulsion: Only one propulsion devise is allowed and the total effort must be applied to the water.

Machinery: The motor brand or make is open, and outboard motor is a mechanical assembly which can be removed from the boat as a single unit, complete with its transmission, and which does not transmit the power through the hull at any point. The motor thus taken off and placed ashore, must be capable of being started, fed by its fuel tank. Any mechanism intended to modify the angle of attachment and/or the height of the motor is authorized.

The mounting supports fixed to the boat, the control levers, the tachometer with its connections, the battery with its conductors and the fuel tank and lines do not form part of the power unit.

Classes	Outboard	Capacity	Fuel
O 2000	1501 to 2050 cc	Sport	Fuel Rule 508.02
O 3000	2051 to 3000 cc	Racing	Fuel Rule 508.03

Low emission engines complying with EPA regulations will be allowed a 30% greater cylinder capacity of their class. In addition, the effect of any air compressor used in support of and as part of the fuel injection system, shall be ignored in determining class displacement.

#### 4. Inflatable Boats Classes:

Classes of Outboard Inflatable Racing Boats: are determined solely on cubic capacity of the engine used and are distinguished as follows:

##### Hull:

- Boats can be inflated only with atmospheric air and the number of independent compartments must be such that the boat can float even if one half of the compartments is deflated.
- The boat must be deflectable, collapsible or foldable so that no dismantled part has a length greater than two thirds of the full length of the inflated boat, excepting the floor boards.
- The keel, inflatable or rigid, must extend along the whole boat and be properly fixed to the transom.
- The transom can be modified only for reinforcement purposes.
- The boats must conform with a model of the official catalogue of the manufacturer published during the last quarter of the previous year.
- Boats with a rigid underwater body made of fibreglass or any other type of rigid material are not allowed.
- Only original features provided for by the manufacturer are allowed under the water line.
- No other material can be inserted or attached between the floor and the bottom of the hull except the keel.
- Class 1,850 V: the only shape allowed is a V shape hull. Boats that tend to have the shape of a multihull are to be excluded, even if they are included in the official catalogue of the manufacturer. The transom must be made of rigid material to adequately support the motor.
- Length of the Hull: The minimum dimension are 3.50 m (11 ft 5 in).
- Racing Capsules: are not permitted.

Engine Mounts: The engine must be attached to the transom of the hull, at least in four points.

Engine Cover: All engines must run with their cover on.

Propulsion: Only one propulsion device is allowed and the total effort must be applied to the water.

Transmission: An efficient gear changing system giving forward, neutral and astern movement is compulsory. The gear control handle must be within easy hand reach of the driver.

Starter: An electric or manual starter must assure quick and easy start without external aids.

Machinery: The outboard motor is a mechanical assembly which can be removed from the boat as a single unit, complete with its transmission, and which does not transmit the power through the hull at any point. The motor thus taken off and placed ashore, must be capable of being started, fed by its fuel tank. Any mechanism intended to modify the angle of attachment and/or the height of the motor is authorized.

To be homologated as a sports motor, an outboard motor must be sold and advertised by an industrial firm as being manufactured in standard production series (with all identical dimensions, weights and material).

The mounting supports fixed to the boat, the control levers, the tachometer with its connections, the battery with its conductors and the fuel tank and lines do not form part of the power unit.

The motor must be able to function at reduced speed. When the motor is in the water, the cooling must be done by the water circulation pump.



Classes	Outboard	Capacity	Fuel
P 550	550	up to 550 cc	Sports Fuel Rule 508.02
P 550 V	550 V	up to 550 cc	Sports Fuel
P 850	850	up to 850 cc	Sports Fuel
P 850 V	850 V	up to 850 cc	Sports Fuel

The engines that comply with EPA regulations will be allowed to compete with a 30 % greater capacity in their corresponding class.

#### **5. Rigid Inflatable Boats Classes**

Classes of Outboard Rigid Inflatable Racing Boats: are determined solely on cubic capacity of the engine used, type of hull and are distinguished as follows:

Classes: as per UIM rule 902.

P850 V

The engines that comply with EPA regulations will be allowed to compete with a 30 % greater capacity of their corresponding class.

Hull: as per UIM rule 902. Hull is monohull

Machinery: as per UIM rule 902.

## **901 - RULES AND CODE OF PRACTISE FOR JETSPRINT RACING**

### **1. GENERAL RULES**

1. **BOATS** Any boat size, type and configuration, with a reciprocating engine, will be permitted, providing the boat is solely propelled by a water jet unit/s, carries two crew persons and complies with all safety requirements as specified under Boat and Safety Equipment rules including an approved Roll Cage.
2. **HULL** Hulls must be of metal construction up to the deck line; the deck line may not go down to the chine. All decks must be fitted in such a way as to add strength to the hull, and be permanently fixed.
3. **EXHAUST** The use of an efficient manufacturer brand muffler is compulsory. All boats will be required to meet supplementary track regulations for noise. These limits shall be notified by the race organisers/promoter 30 days prior to the departure of any international crew. (Opportunity must be given for crew to meet noise restrictions prior to any race)
4. **CONFIGURATION** Driver and crew will sit side by side with a difference in seat placement fore or aft, of not more than 300 mm to each other. Crew shall have a clear and unhindered escape route through the front of any roll cage.

5. All boats must carry two crewmembers (driver and navigator).
6. The timekeeper's word is final and no protests will be considered. The timekeeper's van/area is out of bounds to all competitors and their crew at all times except by direct invitation of the Sprint Controller. This also applies to the race control area.

**PENALTY:** Unauthorised entry to race control area and timekeeper's van/area or contact with the timekeeper - may result in disqualification for the remainder of the day's racing.

7. Any boat may have a maximum of two crews. Each driver is to have his or her own navigator. Doubling up is prohibited (ie. no driver to navigate, navigator cannot drive, navigator can only navigate for one driver, driver can only compete in one class).
8. No driver or navigator may compete in more than one boat or class on race day. However, if a boat is rendered unable to continue racing, the sprint controller may permit the crew to continue racing in another boat, providing they can record a qualifying time in that replacement boat before the elimination rounds commence. Times previously recorded in the disabled boat will be disregarded. Only one boat change per crew per meeting is allowed.

**PENALTY:** Boat substitution or change without approval - disqualification for the day or remaining rounds.

9. All items named in Boat and Safety Equipment shall be available for inspection at the time and place nominated for scrutineering.

**PENALTY:** Race-day non-starter.

10. Scrutineering shall be at a time and place as nominated by the event organiser on the entry form and must be attended by all boats and crews unless prior arrangements are made with the organiser. The scrutineering area is declared an alcohol-free zone.

**PENALTY:** Not attending scrutineering without prior approval - race-day non-starter.

**PENALTY:** Consuming alcohol in any alcohol-free zone - race-day non-starter.

11. Entry forms submitted without payment or incomplete will be deemed invalid and disregarded. Late entries will only be accepted at the sole discretion of the promoter and may be subjected to a late entry fee and/or may be placed on a cancellation list. If a competitor wishes to withdraw an entry prior to the event, refund of the entry fee is at the discretion of the promoter. Entrants who are a "no-show" on race day are not entitled to a credit or a refund of their entry fee.
12. All drivers in order to compete, must be full financial members of their respective country's association or jet sprint authority, financial crew members from affiliated clubs and associations and licensed international crew members are deemed to meet this requirement.
13. Points accrued in any international series will be deemed to have been earned by a driver, not a particular boat or crew combination.

- No driver shall compete with an injury or disability, which, in the opinion of the sprint controller could adversely affect his/her ability to safely and effectively control the boat. This includes the ability of either crewmember to safely and quickly exit the boat following an accident. Medical clearance in writing may be required before a driver or navigator is allowed to race.

## **COURSE DESIGN**

International Events will only take place on suitable tracks homologated by the UIM Jetsprint Working Group. For more information contact the UIM Jetsprint working group chairman

Mr Paul Gaston. Email : uwstippers@bigpond.com

## **EVENT ADMINISTRATION**

- A Sprint Controller will be appointed to control each event.
- The Sprint Controller is the final arbiter for any disputes other than official protests on the day.
- An approved host country authority member who has had at least two years experience in Jet Sprinting shall carry out Scrutineering. Any queries, which cannot be satisfactorily resolved by the scrutineers, shall be referred to the sprint controller for a decision the Sprint Controller is the final arbiter.
- The Jetsprint Working Group reserves the right to alter any of the above rules so as to accommodate any unusual or unforeseen circumstance or errors that may arise from time to time or country to country

## **PROMOTORS RESPONSIBILITIES**

- Promoters of all events must provide adequate first aid equipment, for any likely emergency, and ensure the attendance of qualified first aid personnel and an ambulance available at trackside.
- Promoters of all events must provide adequate fire extinguishing equipment for any likely emergency. (Race gas and Methanol). It is preferable to engage the services of a trained fire crew.
- Promoters of all events must engage the services of at least 20 able bodied people to act as boat pushers. Although the primary requirement is to assist with refloating of boats, which have become grounded, an essential aspect is an ability to quickly react and assist with any craft in difficulties that may endanger the crew. (i.e. a roll-over) The Pushers must be given a safety briefing prior to commencement of the event, so that they are conversant with the requirements regarding the safety of a crew in the event of a roll-over under water and that they are aware all other safety requirements concerning their own safety in the handling of boats.

## **2. BOAT AND SAFETY EQUIPMENT**

### **SAFETY HARNESS**

- Must be fitted for both crew and be securely attached to the roll cage or the seat base bearers. They must be a motor sport type approved and a minimum of 50 mm web for all belts, a 6 point minimum attach point harness and shall have a lever action quick release buckle and be within their use by date as set by the manufacturer. (See roll cage specs) Push lock or twist action buckles are not permitted.
- The mounting point for the shoulder straps behind each crew member must be between a line horizontal to the shoulders, and a line drawn downward from the shoulders at an angle of 25 degrees to the horizontal. If the shoulder straps join prior to a single common mounting point then that junction shall be at least 150 mm behind the crew members neck.
- All harnesses shall be replaced whenever the webbing is cut, frayed or weakened due to the actions of chemicals, abrasion or sunlight, etc. Safety belt harness hardware must be replaced if it is bent, deformed or rusted.
- The lap and crotch straps may not pass over the sides of the seats but through the seats in order to wrap and hold the pelvic region over the greatest possible surface. Care shall be taken that the webbing of the harness is protected against chaffing in any area.
- Shoulder straps must wrap around the horizontal cross bar of the roll cage as the only means of attachment.
- All Drivers and Navigators must be scrutineered with their nominated boat so their safety equipment can be checked for correct size.

- Motor sport type approved arm restraints must be worn on the outside wrist of each crew member and shall be of a length which will prevent the arm from protruding from the boat in the event of a roll over. They must be attached to the safety harness in such a way as to release freely when the buckle is released.
- Head and neck restraints for both driver and navigator are compulsory.  
Seats to be fitted with wings from the seat back head rest protruding out each side of the helmet in a line drawn forward past half the forward length of the helmet when the head is rested to the back of the seat in the sitting position. Head restraints must have the ability to absorb the side to side impact of the head under racing conditions without being left permanently bent out of shape after normal racing. A Frontal Head Restraint (FHR) shall be worn by each driver and navigator which complies with SFI 38.1, FIA 8858 standards. Quick release fixing posts that disconnect the device via a 'tab pull system' for FHR's are mandatory. It is the responsibility of the wearer to ensure that the FHR device that they are using is suitable for the application that they will be wearing it for and consideration of use should be given to FHR devices that are easy to release, have a low upright section at the back of the head.

## ENGINE MOUNTS

- Engines are to be solid mounted to the main engine bearers. Where an engine mount is built to create a frame there shall be a minimum of four, 3/8 in. bolts or metric equivalent to secure that frame to the main bearers of the boat. Where engine mounts create four separate attachment points there shall be a minimum of eight, 3/8 in. or metric equivalent.
- Flexible mounts will only be permitted if they have security through bolting and it can be demonstrated to the scrutineers' satisfaction that the through bolt is designed to restrain the engine should the flexible portion fail.

## FUEL TANKS AND FITTING

- Fuel tanks must be securely mounted and be fitted with a non spill sealing cap. The tank must not be mounted in such a way as to be a stressed or a load bearing part of the boat structure.
- Adequate breathers are to be fitted to the fuel tank, the breather tube must include a non return valve and be vented to the outside of the boat.
- A fuel filler must be fitted in such a manner that no fuel can spill into the hull during refuelling.
- All fuel and vent lines must be resistant to the type of fuel used. All fuel lines must be attached with proper fittings no hose clips or clamping of fuel lines is permitted. (With the exception of the fuel filler to the scrutineers satisfaction)
- A fuel shut off tap or control is optional.

## BATTERIES

- The battery should be of a non-spill, (ie. manifold-vented or gelled type) and firmly secured to the hull or bearers.
- An operating battery isolating kill switch must be installed and located between the seats within easy reach of both crew whilst harnessed in their seats. Metal constructed boats should have the isolating switch to the earth terminal.

## FIRE EXTINGUISHERS

- Approved fire extinguishers must be carried on the front of boat trailers. They must be easily accessible.
- Approved Types: The extinguisher fitted to any boat must be of a type designed to extinguish the fuel type used in that boat.

All types must carry standard approval label. Aerosol types not permitted.

## STEERING

- All shackles and turnbuckles in the steering system must be lock-wired. (Nylon TY wraps are acceptable)
- Chain guards/guides must be fitted to each side of the steering chain sprocket. All open pulleys must be fitted with keepers. Where steering is a lever system any shackle attaching steering cables shall be lock wired. Especially designed taper lock cable joiners may be accepted at the scrutineers' discretion.

All steering cables must be from a braided type wire rope, with a minimum 750 kg breaking strain.

- Jet unit steering shafts where fitted shall have Nylok type nuts, the thread of any bolt must protrude through the nylon locking device or have been locked by fitting two standard nuts.
- An operational reverse is mandatory for all boats.

### ENGINE CONTROL

- Two throttle return springs, either of which is capable of closing the throttles, must be fitted in addition to any internal carburettor throttle shaft springs. Where fuel injection is fitted there will be at least one spring on the accelerator pedal in addition to the factory fitted springs on the throttle shafts. Where this is not possible the spring will be fitted to the main operational lever of the fuel injection where the throttle cable is attached. At all times for any boat the throttle must be able to return to the idle position unaided.
- Any other items that in the opinion of the scrutineer are unsafe must be rectified to the scrutineers' satisfaction.

### PERSONAL SAFETY EQUIPMENT

- Safety equipment must be properly and securely fitted to the crew, prior to the boat lining up at the start line and all must be in place when the boat crosses the finish line. No other items of clothing shall be worn over the fire retardant suit.
- A bow-towing eye with at least a ten mm hole must be fitted with a d-shackle to suit, to aid the rescue crew or towboat to attach a safety line.
- The driver shall be responsible for checking that his or her crew is wearing the required safety equipment and that it is correctly adjusted, before proceeding onto the start line. The starter will visually check safety equipment prior to allowing any boat to cross the start line, but will not be responsible for any item not being in place during competition.

PENALTY: Incorrect fitting or missing safety equipment during run - DNF

- All competitors, pit crew and any person within the pit area, must wear enclosed footwear at all times during racing. (No thongs, sandals or open footwear at any time during racing). The standard race suits shall be a minimum SFI 3.2A/5 or equivalent (FIA8856-1986, FIA8856- 2000). It is recommended that fire retardant underwear be worn regardless of number of suit layers. Rips or tears in the suit must be repaired prior to Competition. Race Boots, fire retardant socks, balaclavas, gloves are to be a minimum SFI3.3 or equivalent (FIA8856-1986, FIA8856-2000, FIA-ISO6940). All the above equipment must be properly and securely fitted to crew prior to the boat lining up at the start line and all must be in place when the boat crosses the finish line. None of the above items of safety equipment may be removed at any time during a competition run. No other item of clothing may be worn over the top of the race suit whilst racing.

Penalty: Loss of any item of safety equipment during a run: D.N.F. Penalty:

Incorrect safety equipment: Start denied

Single Layer Suit		Fire retardant Underwear		Balaclava, Gloves and Boots
SFI 3.2A/1 ASCF RA011	plus	FIA8856-1986 FIA8856-2000 SFI 3.3	plus	FIA8856-1986 FIA8856-2000 FIA- ISO6940 SFI 3.3
or				
Two plus layer suit			Balaclava, Gloves and Boots	
FIA8856-1986 FIA8856-2000 SFI 3.2A/5		plus	FIA8856-1986 FIA8856-2000 FIA- ISO6940 SFI 3.3	

- All competitors whether they are competing, or practicing must wear a correct fitting approved helmet; motor sports type neck brace, Frontal Head Restraint (FHR) which satisfies SFI 38.1 or FIA 8858 standards, arm restraint and enclosed footwear and fire retardant suit. The FHR should be of the lower profile design behind the head and utilize quick release tether fasteners. A fire retardant suit must be worn. Cotton workman overalls will not be accepted. All competitors must also wear arm restraint, race / leather boots, fire retardant socks, balaclava, gloves.

- Any brand of crash helmet is allowed provided they meet the SNELL, FIA standards specified on the UIM website. Open face types only. All helmets must be in excellent condition with no frayed chinstraps or rusted anchor points and must correctly fit the person who wears them. Full-face or types with removable face pieces are not acceptable. Air breathing systems acceptable.  
Exception: Full face helmets may only be used if fitted with an air breathing system.
- A working bilge pump is optional.

### 3. ROLL CAGE SPECIFICATIONS

- A roll cage, which meets these minimum specifications, must be fitted to all boats.
- Boats not complying with these standards will not be permitted to race.
- The intention of these specifications is to provide the best possible protection to drivers and navigators, taking into consideration the accidents, which have occurred within the sport, and best practices in other motor sports. No guarantee is implied or stated, nor is any responsibility taken, regarding the degree of protection or safety afforded by any roll cage constructed to these specifications. Owners are encouraged to seek the advice of a structural engineer qualified in roll cage design.
- All jet sprint boats are to have roll cages constructed so that all parts of the crew's bodies above the deck line are contained within the roll cage structure. At the same time, the roll cage should provide minimum restriction to the driver's vision to the sides or front and must allow quick and easy access and exit, especially in the event of an inverted accident. While different designs of roll cages will be permitted, each design must satisfy the requirements stated above and be constructed to the following minimum specifications.

#### ROLL CAGE CONSTRUCTION MATERIALS

- Only round chrome moly tube is acceptable minimum diameter 38.1 mm Wall thickness 2.1 mm.
- Capping plates - minimum 3 mm steel or chrome moly. Roll bar capping must not be drilled or have welds ground back for appearances.
- Attaching plates - minimum 5 mm steel or chrome moly.

#### WELDING & FORMING

- All joints must be fully welded by a competent welder with all welds being of good external appearance and remain un-ground using the TIG or MIG process with the 4130 filler wire, for chrome Moly.
- Joints should be preheated and welded in 90-degree increments to avoid brittleness. (Chrome Moly)
- Tube must be contoured and shaped for a close fit prior to welding.
- Tubes cannot be flattened in order to make a joint.

#### CONFIGURATION

- All bracing and the rear A frame must be straight between attachment points. (Drawing one)
- The main A frame roll cage structure and brace bars must be of one-piece continuous tubing. No welds permitted other than at attachment points and capping plates.
- The top corners of the overhead framework must be formed with one 90 degree formed on a bender suitable for bending the chrome moly size used.
- The two A frames must be spaced apart a minimum of 100 mm between centres.
- Capping plate (3 mm) must be welded to each corner of the A frame covering the entire bend. (May be mild steel)
- A minimum of one (3 mm) plate or tube must be welded in between the capped A frame corners between the top bars.

7. The mounting points on the cage for the shoulder straps behind each crew member must be between a line horizontal to the shoulders and a line drawn downward from the shoulders at an angle of 25 degrees to the horizontal.
8. The two A frames must have a brace on the side so as to form an A section on the side of the cage and should where possible also be attached to the side panel (gunwale) as well as the chine.
9. Helmet Clearance; 5 or 6 point harness, a minimum clearance of 100 mm from the top of the helmet to the underside of the cage top bar must be maintained for all crew.
10. An X styled brace going from the upper outer A frame to either:  
The back cross bar and then down to the engine bearers or outer chine area. (The bottom part of the X brace can be removable in this configuration provided suitable hardware is used)  
Goes directly to the engine bearers or chine and joined where they intersect. (If the lower part of the X brace goes to the chine it must have suitable load distributing plates on attachment points)
11. Seats must mount to the one piece cross bars shown in drawing three and be attached at all manufacturer located mounting points or a minimum 4 points at the base and 1 at the back above the shoulder line of any crew.
12. All attachment points to the seats must be a minimum of 3 mm mild steel and able to support the entire weight of the crew throughout any crash without distortion to the mount between the seats and roll cage crossbars or cross members.

#### METHOD OF SECURING

1. Attachment plates or load-spreading flanges must be welded to the tube ends to secure the cage to the boat and must be at least 5 mm minimum thickness.
2. For rectangle attaching plates:  
Minimum width of attaching plate = tube diameter.  
Minimum length of attaching plate = tube diameter x 2.
3. For circular attaching plates:  
Minimum diameter of round flanges should be tube diameter x 2. The roll cage may be bolted or welded to the boat as defined below.

#### ANCHOR POINTS

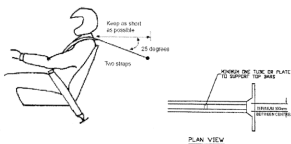
1. The primary elements of the roll cage must be secured to the main engine bearers and the chine.
2. In the absence of chine bearers in an alloy boat, the cage should be attached in the chine area of the bottom skin with load-spreading flanges as above.
3. In addition to the above, the main roll bar structure may be attached to the fore or side deck, provided that a brace bar of the same type and size material as the roll bar continues the load path through to the bottom of the boat. Provided the primary elements of the roll cage structure attach to the boat bottom as stated above, then braces may be attached to the roll cage in order to strengthen the boat sides or deck structure.

#### BOLTING

1. Through bolting with back-up washers.
2. Minimum of two bolts per attachment point.
3. Minimum bolt diameter 3/8in for two bolts, four bolts - 5/16, six bolts ? etc or metric equivalents

## CREW PROTECTION

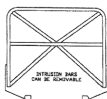
- The driver and navigator must be able to exit an inverted boat through the front area of the roll cage with no frame members in such a position as to impede their exit or rescue.
- The frame of the cage must protect the crew from any frontal or inverted impact to their head and torso and must be able to restrain the engine from moving forward far enough to cause injury by having suitable cross-members in place.
- A minimum clearance from the top of the crews' helmet to the underside of the roll bar will be 100 mm (4 inches) for a five or six-point harness.
- Roll cage padding with a minimum 20 mm thickness must extend a minimum of 180 degrees around the roll cage tubing, and be of high density foam padding. Padding is to be placed where in the event of an accident the expected trajectory of the occupants heads are likely to make contact. It is not advisable to place this roll padding above the helmet area if it reduces the helmet clearance specifications. Recommended but not compulsory.



PLAN VIEW



BACK VIEW



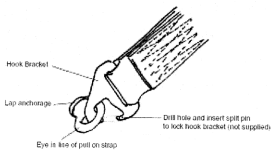
BACK VIEW



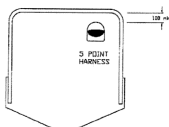
BACK VIEW



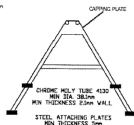
BACK VIEW



A split pin must lock the seat belt hook to the lap anchorage.

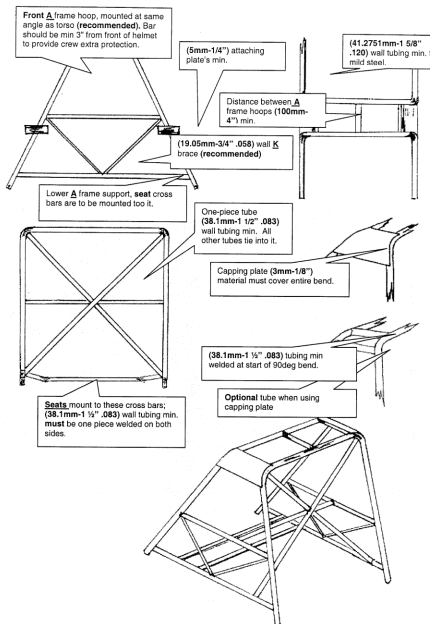


HELMET CLEARANCE



SIDE VIEW





## 4. INTERNATIONAL JET SPRINT CLASSES

### SUPERBOATS

1. All naturally aspirated engines must be a minimum of 6.5 litres displacement, and if any naturally aspirated engine is under seven litres displacement, it must be equipped with alloy heads, use methanol fuel and have multi carburetors or fuel injected induction system.
2. Forced induction engines must be a minimum of 3.8 litres displacement.
3. Under special circumstances it may be possible by request, to have boats that do not comply to the above requirements, to be awarded Super boat status.
4. If Superboat status is granted, the boat will only be eligible to compete in the Superboat class for that season then would need to re-apply.
5. The use of fuels other than petrol is permitted. The only Methanol (alcohol) fuel is Mobil No 5 and equivalent Oil Company brand Fuels. The use of any nitrous oxide or nitro Methane type fuels is prohibited.
6. The minimum age for Super class competitors shall be 18 years of age for drivers and 16 years of age for navigators. Proof of age will be required on demand.

7. Injected or supercharged engines that require external fuel priming for starting purposes shall have one crew member identified as the primary starter for that boat. This person shall be equipped with and wear the following at all times whilst attending to starting duties on the boat ramp (including warm up facilities). Fireproof balaclava, minimum fireproof arm sleeves, eye protection. A single layer fire suit is deemed adequate arm protection and recommended. One primary starter may act for several boats.

Penalty for missing safety equipment for primary starter whilst externally priming the fuel system is a DNS in the offending round. Applies to qualifying and elimination rounds.

## **INTERNATIONAL GROUP A**

1. The minimum age for Group A competitors shall be 16 years of age for drivers and 16 years of age for navigators. Proof of age will be required on demand.

## **JET UNIT**

Single unit only, direct drive only (no gearboxes) otherwise no restriction.

## **ENGINE CONFIGURATION**

2 valves per cylinder, push rod operated, maximum of 8 cylinders, single engine and internal combustion only. The nominal section of each cylinder must be circular.

## **OILING SYSTEM OPTIONS**

1. Dry sump systems, no restriction on system - The drive shaft angle can only be parallel to the delta or angled upwards (i.e the crankshaft center line height cannot be below the unit shaft center line height).
2. Wet Sump Systems – Vacuum pumps permitted

## **CONRODS / CRANK**

No Titanium or aluminium.

## **ENGINE BLOCK**

Cast iron only.

## **ENGINE CAPACITY**

412 cubic inches (6,752 cc) maximum swept volume.

## **CAMSHAFT**

One only in OEM production location. No restriction to valve lift or rocker ratio. Shaft mounted rockers are permitted. Offset rockers are permitted to relieve the problem of pushrod to cylinder head interference created by some aftermarket heads. Maximum offset is 0.250". Offset rockers are permitted for OEM cylinder heads where pushrod tubes have been inserted to gain port width comparable with aftermarket castings. Max offset is 0.250". Devices that vary the valve timing whilst the engine is operating are prohibited.

## **CONNECTING RODS**

Must be of ferrous alloy material.

## **CYLINDER HEADS**

Cast iron only. OEM location in relation to bore only. Valve angle 23 degrees to block face, original cylinder head manufacturers location only No angle milling allowed. Maximum 0.50 degree (either way) valve angle testing tolerance measured from block deck surface. Block deck surface to be 90 degrees from bore centre line.

## INTAKE PORTS

Cylinder head Intake port dimensions at manifold flange are not to exceed an unmodified Felpro 1207 gasket port opening (Felpro published dimensions 1.38"x2.28").

## INTAKE PORT & BOLT LOCATION

OEM production location. No high port or raised runner heads. Felpro 1207 max size gasket template must be in original cylinder head manufacturers position and orientation in relation to bolt holes. No part of the intake manifold gaskets may protrude into the ports. Maximum distance of 2.500" allowed from roof of port to block surface side of head. Measurement is made along the plane of the intake flange face and not perpendicular to deck surface. (Chevrolet specific rule only).

## EXHAUST PORTS OEM

Production location only. Exhaust flange adaptors are permitted as long as no material from the manifold, the adaptor or any gaskets or seals protrude into the port past its original outside face.

## VALVES

Maximum sizes - 2.125 inch intake, 1.625 inch exhaust.

Valves may only be opened by mechanical action, and can only be closed by means of coil springs. There are many after-market manufacturers that produce complying cylinder heads - GM Bowtie, Dart etc. There are also some cast iron heads produced as "23 degree" that don't meet the specified rules. Some heads angle milled from the factory are an example of this.

## INDUCTION

Naturally aspirated only via a single 4-barrel carburettor with a maximum of 4 venturis. Carburettor throttle body bores below the throttle shaft centerline shall not exceed 1-11/16 inch diameter. Butterflies or throttle blades shall not exceed 1-11/16 inch diameter.

Compliance will be checked by measurement or a "Go-No Go" type gauge applied to the throttle body bore below the throttle shaft centerline.

Any mass produced cast intake manifold is permitted. Inlet manifold must use OEM bolt pattern and position to mount to cylinder heads without the use of adaptors or spacers.

No sheet metal or tunnel ram style inlet manifolds are permitted. The intake manifold must remain largely visually standard and unmodified from the outside. Sectioning the plenum for porting access and re-welding is a permitted exception. No additives may be discharged into the inlet tract. Any device which alters the configuration of the manifold/induction systems (e.g. movable inlet rams) or exhaust while the engine is operating is prohibited.

Engines not exceeding 365 cubic inches maximum swept capacity may be fitted with aluminium cylinder heads conforming with these rules only.

## FORD ENGINES

Same common rules as Chevrolet engine, except :

Cylinder heads - Valve angle only 20 degrees to block face (OEM specification) Original cylinder head manufactures location only.

Intake ports - Template FELPRO gasket 1262r max size (Published dimensions 1.40" x 2.25").

Offset rockers are permitted as per Chevrolet (max 0.250").

Intake ports & manufacturers - Felpro 1262r max size gasket template must be in original cylinder head manufactures.

Bolt location - position and orientation in relation to bolt holes Maximum distance of 2.500" allowed from roof of port to block surface side of flange face and not perpendicular to deck face. Production location only.

Valves - Maximum sizes = 2.125 inch intake 1.625 inch exhaust.

Intake manifold - Any mass produced cast intake manifold is permitted. Inlet manifold must use OEM bolt pattern and may not use spacers or adaptors to bolt up to heads to allow for differing deck heights in Ford production blocks. Manifold must be designed for deck height block used.

### **TRADITIONAL PONTIAC ENGINES**

Same common rules as Chevrolet engine except.

### **CYLINDER HEADS**

Cast iron only. Valve angle 14 degrees to block face (OEM specification), Original cylinder head manufacturers location only. D-port or round port exhaust.

### **INTAKE PORTS**

Template TIP gasket 120240 max size (Published dimensions 1.20" x 2.40"). Offset rockers are permitted for OEM cylinder heads where pushrod tubes have been inserted to gain port width comparable with aftermarket castings. Max offset is 0.250" .

### **VALVES**

Maximum sizes - 2.110" intake, 1.770" exhaust (OEM 400 cid).

### **EXHAUST PORTS**

Exhaust crossover, EGR or heat riser passages may be filled with aluminium. Epoxy may be used to seal this at the intake manifold flange.

### **INTAKE MANIFOLD**

Separating the water crossover from the intake is an acceptable modification.

NOTE: Engine options may be expanded in the future provided they offer a similar power-to weight ratio. Applications for engine consideration must be made and supported by full technical specifications. Any engine under consideration will be subject to supervised trials before approval for competition is granted.

### **COMBINED RULES AND LIMITS ON MODIFICATION (ALL MAKES)**

No angle milling of heads allowed. Maximum 0.50 degree (either way) valve angle testing tolerance applies to factory valve angle.

Porting is permitted but no material may be added to any part of the cylinder head casting (unless specified in that engine family specific rules) Includes but not limited to aluminium ramps, epoxy, brazing, furnace cement etc.

Welding is permitted for crack repair purposes only but is limited in the port, intake and exhaust runner area to a maximum of 2 repairs per cylinder head.

Welding in the chamber area for crack repair only is limited to 2 chambers per head but must not alter the shape or size of the combustion chamber.

Replacement of valve guides are not considered to be a repair.(see below).

All machine work for valve guides, spring and valve seats must remain parallel & in original cylinder head manufacturers position. No offsetting of valve guides is permitted.

Any machined surface must remain parallel to original surface.

Repair sleeves or tubes of any material may be fitted to either the head bolt or pushrod holes.

Head bolt = 1 repair max per cylinder head.

Pushrod hole/slot = 2 repairs max per cylinder head for aftermarket cylinder heads.

Pushrod hole/slot = 4 sleeves or tubes permitted per head for OEM heads to gain port width comparable with aftermarket castings. Max rocker offset is 0.250" .

No restriction on intake valve seat inserts. No

restriction on exhaust valve seat inserts.

## CONTROL FUEL

Will be provided at all international meetings by the promoter and paid for by competitors of the class involved.

## FUEL

Will be 100 octane Race gas. The control fuel will be dispensed either from a central point to which each boat must come, or by smaller containers refilled from the main source. The scrutineer will be in charge of and oversee all refuelling operations. Fuel tanks are not required to be drained prior to the addition of control fuel provided that a tank has maximum capacity of not more than 30 litres.

## 5. TESTING PROCEDURES

- At any meeting, any boat's engine capacity and compliance with restrictions may be tested, at random, without notice. The decision to conduct testing shall be made by the committee prior to the commencement of that meeting. Other boats may be tested, time permitting, as the chief scrutineer or his appointed deputy sees fit, but only after they have been eliminated for that day.
- The crew of any boat found to have an illegal engine capacity or components outside of the specifications or restrictions will be disqualified and will lose all points and placing's gained since that boat's last compliance test.
- The crew holding lower placing's will move up in the finishing order one or more positions as required. Where boats are disqualified and the finish order reshuffled, the top three must still be tested prior to presentation.
- Testing will be conducted by the chief scrutineer or appointed deputy and in the continual presence of the boat owner or designated representative.
- Refusal to allow an engine to be tested will be taken as evidence of over-capacity or outside of specification and the stated penalty applied immediately.
- The results of the capacity and compliance testing as detailed will be final and no protest will be entered into provided the equipment falls within its manufacturer set tolerances.

Note: All testing methods must be approved.

## TESTING APPARATUS

- A measuring flask of 1,000 cc's certified capacity (known brand name) and have sufficient height so as to have distinct and well-separated graduations.
- A length of flexible hose 300 mm to 500 mm long with one end attached to the bottom of the measuring flask, the other end able to accept either a large or small spark plug hole fitting, drilled to allow fluid to pass.
- One litre of testing oil, to be a recognised upper-cylinder lubricant.

## METHOD OF TESTING GROUP A CLASS

- Engine must have: - All spark plugs removed, one rocker cover removed, both rockers on one cylinder backed off, so that the valves remain closed at all times.
- Bring the piston to approximately TDC on the cylinder being tested.
- Screw the measuring flask connecting hose into the spark plug hole.
- Fill the measuring flask with testing oil and raise the flask above the cylinder, keeping the connecting hose as vertical as possible.
- Turn the engine over slowly by hand until no more air bubbles are expelled.
- Turn the engine over slowly by hand three times, recording the maximum and minimum level readings each times. (At all times, the oil level must remain within the graduation range of the flask). The oil level may be topped up in between reading sets if necessary and the process should be repeated until two readings are within 8 cc of each other.
- Taking the difference between the two readings and multiplying by the number of cylinders will yield the total engine displacement. For Group A boats, this may not be more than 6752 cc or 412 Cubic inches.
- Maximum allowable capacity for one cylinder is  $844 \text{ cc} + 1\% = 852 \text{ cc}$  for Group A boats. (8-cylinder engine)

9. The engine will be classed over-capacity if: Measuring flask reading is more than 852 cc (for Group A) per cylinder, the engine cannot be turned over one full revolution.
10. Oil leakage from the cylinder is such that no two readings are within 8 cc (in this case, another cylinder must be tested. The number of cylinders to be tested is at the scrutineers' discretion).
11. Note: Competitors suffering a total engine failure, such that the engine cannot be capacity tested as above will be workshop capacity tested.
12. The method of testing Superboat engine capacities, will generally be those as indicated above for Group A class, however capacities should be substituted so as to comply with the class capacity rules.

#### **WORKSHOP CAPACITY TESTING**

1. Only one head of a "V" configuration engine need be removed to enable access to the cylinder bore for the purpose of accurately measuring the bore and stroke of that engine. The resultant calculated swept volume shall not exceed 412 Ci. or 6752 c.c.'s for Group A. At this time the engine should be measured and inspected for full compliance with the specifications outlined herein.
2. There shall be no tolerance permitted when the capacity is measured in this manner.

#### **6. SPORTSMANSHIP AND COMPETITOR CODE OF CONDUCT**

1. There is a total commitment to promote and foster good sportsmanship within the jet sprinting movement. This is to assist in the creation of a strong, positive public image of a group of competitors with a professional attitude, providing exciting, spectacular entertainment.
2. All competitors, their crew and race officials are expected to understand and display, in public, all those qualities which define good sportsmanship.
3. Obvious public displays of bad sportsmanship by any member will be considered a breach of the code of conduct and subject to disciplinary action.
4. The code of conduct requires not only a public display of good sportsmanship, but compliance with the rules of racing and the contractual obligations of the individual competitors and their teams via the signed entry forms carrying conditions relating to behaviour and general codes of practise as outlined in these rules.
5. During a pit walk by members of the public at least one member of the boat crew shall remain with the boat to foster good relations and public image by interacting with spectators as they view the boats in the pit area.
6. All personnel involved with an event, competitors, their crews and officials are required to function within the code of conduct.
7. The pits are a controlled-access area and an alcohol-free and smoking-free zone. Entry is confined to competitors who are entered on the day, pit crew, officials and those holding pit passes. Non-competing, financial members may not use their licence as a pit-pass, and not as a free event entry pass. Children must be under the control of a responsible adult at all times.

PENALTY: Abuse of licence. Cancellation of licence for six months.

PENALTY: Smoking or drinking alcohol in the pits - exclusion from the pits for the remainder of the meeting. Competitors or officials will be suspended for one meeting. Repeat offence - 12 months suspension.

8. There is a total ban on the consumption of alcohol and any other intoxicating substances by all boat crews and all event officials, including safety crews, for 8 hours prior to the commencement of briefing and for the duration of the meeting, or until they have completed their racing activities for the day. No crewmember, or support crewmember may consume alcohol whilst wearing racing apparel. Crews are required to have a zero blood alcohol content prior to racing and to comply with insurance conditions. Breathalyser testing of crews may occur, prior to commencement of racing. This ban applies to prescribed drugs and other performance-affecting substances. No alcohol may be consumed in the pit area by any person during racing.

9. A declared alcohol free zone refers only to the consumption of alcohol and/or prescribed drugs by any person in that area, and does not presume to enforce civil law relating to the possession or presence of it in a vehicle which may be parked in that area. However, any member who willingly breaks a civil law concerning prescribed substances in a manner which brings the sport into disrepute, may be deemed to be in a breach of the code of practice and can be penalised as provided for in the general rules of IJF.

PENALTY: Consumption of alcohol during meeting: minimum one meeting ban.

PENALTY: Competitors registering any blood/alcohol content prior to racing: - start denied until breathalyser registers zero.

10. Smoking is prohibited in the pit area. Any person smoking in the pit area may cause the disqualification of their associated boat. A crew smoking area may be established adjacent to the pit area at each track.

PENALTY: Disqualification for remainder of the days racing.

11. No competitor may abuse a race official. Any competitor, who has a dispute with any official on race day, must present the details of the problem to a class representative who may consult with the Sprint Controller for resolution. Likewise, any competitor who has any complaint concerning the running of the race day must firstly present the details in person to a crew committee member. If no committee members are present, then the complaint may be presented to a race official.

12. No official may abuse a competitor. If there is a perceived problem with the behaviour of a competitor, the matter must be brought to the attention of the sprint controller. (The disputes committee will be comprised of the sprint controller, host country representative, and IJF representative)

PENALTY: Abuse of official: disqualification for remainder of the day. Further penalty may be applied.

13. No competitor or crew shall be involved in any instance of dangerous behaviour, or conduct which deliberately causes or could cause disruption to a race meeting, nor may they take any action, verbal or otherwise which may be deemed to bring the sport into disrepute.

PENALTY: minimum: disqualification for the day - further disqualification possible at the discretion of the UIM.

## PENALTIES

- For any offence occurring on race day or as a result of scrutineering, the maximum penalty, which can be imposed by the Sprint Controller, shall be disqualification for that day. Additional penalties can only be imposed by the disputes committee following race day and after consultation with all parties concerned with the incident.
- A penalty for a breach of the rules may, at the discretion of the sprint controller, be in the form of a suspended penalty and shall remain current for a period of up to one year from the time of the offence. Any further breach of the rules within that time shall cause the suspended penalty to be immediately applied.
- Suspension penalties for one or more meetings shall apply from the next listed meeting and if more than one, shall be consecutive.

## OVERVIEW

- The Sprint Controller shall have certain discretionary powers to deal with disputes and may make a ruling concerning a dispute.
- The ruling will be given after due and careful consideration of the issues involved and will be final. It will not be open to further discussion on the day.
- Any ruling, which affects the results of the day, may not be challenged on that day, but can be subject to appeal by affected competitors as per the appeals rule.
- The disputes committee will formally advise affected persons that they have been reported for a breach of the rules or the code of conduct.

## APPEALS

1. The disputes committee will be comprised of the Sprint Controller, host country representative and the Commissioner.
2. Whenever possible and practical, the Sprint Controller will consult with the disputes committee when considering disciplinary action.
3. The sprint controller, may request a competitor to attend a meeting of the disputes committee, either during the event or at some other suitable time, to provide good reason why they should not have disciplinary action taken against them for a breach of the rules or code of conduct, which in the opinion of the sprint controller, could bring the sport into disrepute.
4. Failure to attend such a meeting will result in the immediate imposition of the appropriate penalty without right of appeal.
5. Notwithstanding the listed penalties, it is policy to apply penalties progressively. A warning may be issued followed by the prescribed penalty for a repeat offence.
6. A non-time related protest must be submitted in writing by a competing crewmember and accompanied by a US \$100.00 protest fee (or equivalent). It may be lodged immediately or at latest, within 15 minutes of the occurrence and handed to a class representative and the sprint controller. The disputes committee will hear the protest as soon as possible and if upheld, the fee will be refunded.
7. Any competitor who protests the eligibility of the engine of a competitor, shall be liable for all costs associated with the testing of that engine, including parts and labour if necessary, should it be proved to be legal. If the protest is upheld, the owner shall bear all associated costs.
8. Members seeking information on rule interpretations must first consult with a class representative, but if none are available, then the sprint controller may be approached.
9. Any member subjected to disciplinary action may lodge a formal appeal within 7 days of a penalty being imposed. Refer to the UIM appeal rules.

## 7. EVENT RULES

### DEFINITIONS

Commissioner - The UIM appointed representative.

Class representative - The selected person to represent the drivers of a particular class on race day. Disputes

committee - The sprint controller, a host country representative and the commissioner.

DNS - did not start.

DNF - did not finish.

Qualifying - The rounds in which a competitor can take their best time to secure a place in the elimination.

Elimination - Meaning the rounds where a competitor has only one opportunity to progress forward with their fastest previous time. i.e. qualified time to fastest 16, fastest 8, fastest 4, fastest 2.

Run - The completion of the prescribed track by following the course directions as handed out on an official map of the race course at a given event.

Class representative - The selected person to represent the drivers of a particular class on race day.

### PROCEDURE FOR CALCULATING POINTS IN A CHAMPIONSHIP

Points shall be awarded depending on the placing achieved in a race as follows :

First place : 40 points

Second place : 39 points

Third place : 38 points

Etc ..

Down to Fortieth place (40th) : 1 points



Should there be more than 40 crews competing in any one class this system would need to start with the first place being awarded 50 points decreasing to 1 point for 50th.

If the event of a tie for 1st or 2nd position at the completion of the series a run off shall be held immediately.

## SIGNALS

- Flags will normally initiate starts, however light signals may be used. A boat may not start until the starter gives the appropriate signal. This is a safety requirement and the driver and navigator must be satisfied that the previous boat is back in the pit area and clear of the spinout pool, the towboat is back in the pit pool and all safety crew groups are in position. (Note that the timing is triggered by the boat at a point some distance after the start lights and therefore does not commence with the display of the green light).
- Each group of safety crew may have a red and green flag. In this instance, unless the track is clear of boats, crew or unplanned obstacles, a red flag will be displayed and a start is not permitted. A green flag signifies that the particular section of track is clear and the safety group is in position. Where it can be demonstrated that the event is efficiently controlled by two-way radios the requirement for the flag system may be waved in consultation with the sprint controller.
- Signals - Due to the noisy environment, signals will be utilised by the starter and the safety crew. The starter has control of the start lights or flags which will be:

**RED** You may not start or pass this point under any circumstances.

**AMBER** A start is imminent, you should be idling toward the start line and are under the control of the starter.

**GREEN** You are cleared to start. The two and ten minute time limits do not apply for a normal start. (Time does not start until the timing beam is broken)

**BLACK** You are disqualified for that run.

**PENALTY:** For jumping the lights or start signal or being out of position - 10 seconds added to the time for that run. If a dangerous situation is caused, a disqualification will occur.

## RACE PROCEDURE

- Each race event will commence with a roll call and crew briefing, the time of which will be advised to all drivers entered. All competitors, both drivers and navigators, must attend the pre-race briefing, the track walk safety inspection and sign any liability waiver form before racing. Competitors must be in attendance at roll call and/or briefing. Competitors who suffer an incident outside their control, and who in the opinion of the sprint controller were making every reasonable effort to attend the event on time, may be allowed to compete. In this case the competitors will be given a full and separate briefing prior to competing. As part of the briefing all crewmembers must be invited to raise any concerns over course safety.

**PENALTY:** Late to roll call on race day - disqualification for the day.

- Event, track or boat sponsors who compete as guest navigators must sign the waiver form prior to their run and wear all specified safety equipment.
- While racing is in progress, each boat is to have one crewmember at the boat or close by in the pit area, in case of a change to the running order.
- There is a speed limit of 5kph or minimum idle in the pit pool and on entrance thereto, where a spin-out pool is provided each finishing boat must use this facility to reduce speed to idle, prior to entering the channel approaching the pits. If there is no spinout pool, an alternate procedure will be advised either at the crew briefing, or in the track supplementary regulations.

**PENALTY:** Speeding in pits and/or creating a wash hazard or other danger - disqualification for the remainder of the race day.

- No person other than official, licensed entrants and the towboat driver shall drive or compete on the track on race day without the consent of the sprint controller.

**PENALTY:** Disqualification for a period of up to one year for the crew involved.

- Boats will start from idle power in forward thrust and may not accelerate until given the start signal which will be when they are wholly within the start gate as indicated by the starter. Cones, on the bank adjacent to the start channel, will normally mark the start gate. A third cone will indicate the 10 m-aborted start limit.

7. If upon initial acceleration a problem occurs with the engine or jet unit, the driver may request one re-start immediately by reducing power and raising an arm. The boat must return to the pit-pool via the shortest possible route to the spinout pool at reduced speed before rectifying the problem, e.g. weed in intake. Use of this rule to obtain an advantage will result in a DNF (Note that time limits may be applied to restart).
8. Only one re-start will be permitted per boat per round and the abort signal must be made within 10 m of the start. (A marker will be positioned to mark this limit). This allowance is not meant to compensate for a poor start and will be at the discretion of the sprint controller.

PENALTY: Aborting the run more than 10 m from the start - DNF (see also event rule 14).

9. If a boat becomes grounded during a run, the crew may attempt to re-float their boat, only by manipulation of the engine and jet unit. They may not receive any outside assistance and no item of safety equipment, including safety harness, may be removed during this attempt. Timing will continue until the crew is successful or the driver turns off the engine and calls for assistance by raising an arm. If the attempt is successful, they may continue racing and can record a time. (There will be a 20 second time limit on re-floating your boat in this manner).

PENALTY: For removal of safety equipment or receiving outside assistance - DNF.

10. When a boat is grounded and the assistance of the safety crew is required, the following procedure must be adhered to: The driver must shut off the engine and raise one arm to signify that assistance is required.
11. Assist the safety crew to re-float the boat by getting out if required by safety crew. Once back in the water, ensure that you have permission from the safety crew before you restart your engine and move back to the pits. Once re-started, drive back to the pit pool by the shortest route to the finish line at a speed only fast enough to prevent further grounding in shallow channels. Boats may not return to the pit pool via the start line channel unless indicated by the starter.

PENALTY: failure to comply DNF for next round.

12. If the tow-craft is called for, but then not required, the boat may not proceed to the pits until the tow-craft has been turned around and returned to the pit pool. If a dangerous incident is created a penalty will be imposed. Once re-started, a crew may not continue to drive the rest of the course as practice.

PENALTY: DNF for the next round.

13. Whilst racing, a boat may not pass through the finish line at any time other than at the conclusion of its run.

PENALTY: DNF

14. During a run, if a crew notice any dangerous circumstance, distraction or an unusual object in the track, eg. a floating tyre, they can abort their run by slowing down, raising an arm and immediately returning to the finish via the quickest and safest route. If the safety crew can verify that there is an obstacle they will remove it and the crew will be allowed to re-start. The race controller is to decide on circumstance or unfair distraction. This allowance may not be misused to compensate for a bad run.

PENALTY: If no obstacle or circumstance or unfair distraction found- no re-run and DNF.

15. In the event of no primary or back-up time being recorded by the timekeepers for a particular run, that crew will be allowed a second run, which should be made as soon as possible and may be added to the next round. If a boat is unable to make a re-run due to mechanical problems, then its previous best time at that meeting and on that track direction, will be recorded.

16. Once a crew has made their first run of the day they may not change their roles, that is, a driver cannot change places with the navigator. In the event of a crew member being unable to continue racing due to illness or injury and at the discretion of the sprint controller, substitute crew may be used provided that:

The substitute driver; May having completed all pre-competition formalities and already a competitor on the day can race another boat providing he/she is able to complete at least one qualifying round before commencing the elimination rounds. Any previous times recorded by that driver will be disregarded.

Once eliminations have commenced, a substitute navigator may be used, but only from a previously eliminated crew and only after it is established that the previous navigator is unable to continue. A driver may not be substituted once eliminations have commenced.

PENALTY: Role changes or unauthorised substitution of crew: disqualification for the remaining rounds.

17. A crew must be ready to start in the correct running order in each round. If there is a problem, the starter or pit Marshal must be notified of the problem in advance of their start order. If sufficient notification is given, the crew will be allowed to start later in that round.

18. In the case of a "B" crew near the end of the running order, they will be allowed a start in the following round, with their time counting for the previous round.
19. If a problem with a boat occurs in a qualifying round, there is a two-minute time limit upon repairs. This time limit will commence from when the last boat in that particular round enters the pit pool at the conclusion of its run and the time will be displayed on the main timing system display (where practical). The time count ceases when the subject boat is moving toward the start line, under its own power, with both crew on board, all safety equipment in place and under control of the starter. From the top16 down, the time limit shall be ten minutes and will apply from the time the affected boat is due to start in order, other boats will continue to race until the time has elapsed. If the affected boat cannot continue after ten minutes has elapsed, the timer will record a DNS. (The time count ceases when the subject boat is moving toward the start line under its own power ready to race). The sprint controller will be responsible for keeping time in this instance. At all times, the pit marshal or starter must be kept informed as to the status of the boat. A time-out is declared if the scrutineer is required to inspect a damaged boat and he/she must be completely satisfied that the boat is safe and fit for racing. No further work may be carried out during a scrutineering "time out".

PENALTY: Not notifying Pit Marshal or Starter of a problem or an inability to start in order - DNS. PENALTY: Exceeding the two or ten minute time limits - DNS.

19.1 In the event that a Dummy grid is to be used to stage boats for launching, the boats must be at the dummy grid within 5 minutes of their "Last Call". In the event that a crew notifies the race controller of a problem with their boat they will make good their repairs within the allocated time frame (see rule 19) at the dummy grid under the supervision of the race controller or his steward without impedence to any other crew.

20. Any boat, which suffers a heavy impact or obvious damage in a racing accident, must be re-scrutineered before further competition. The re-scrutineering process will take place after any work to repair damage to the boat has been completed, but shall have time constraints such as meeting the appropriate time limits or qualifying rounds. The boat may not be returned to the water until the scrutineer has declared it safe for competition. In the absence of a scrutineer the sprint controller will re-scrutineer the boat. Likewise, the crew must be checked by the ambulance or first aid crew and declared fit to resume racing.
21. On race day, there will be a minimum of two (2) qualifying rounds, but normally three. If the qualifying rounds are reduced for any reason once racing has begun, the first elimination will include all entrants affected. (Elimination rules apply to such rounds). Formation of the elimination rounds will be advised on the event programme, or at drivers briefing. The cut progression will be advised prior to the running of that segment, but will normally be 16-8-4-2. The running order from the top 8 down must be slowest first. Where there are insufficient numbers to make up an elimination round, the round will still be treated as such, until the relevant cut can be made. (Elimination rules apply to such rounds).
22. Due to a number of variables such as weather, accidents, crew and boat numbers, the sprint controller retains the right to vary the progression of the elimination cuts. Crews will be informed of variations in advance.
23. Regardless of the number of crews available, no crew may be included in the elimination rounds without recording a qualifying time.
24. During the eliminations, if two crews record equal times in a particular round and that time qualifies for the last spot in the next round, they shall both be included in that next round, even though it adds an extra boat to that round. The following cut however, will be as previously established.
25. In the elimination rounds, if more than one crew records a DNF in any elimination round, their respective positions in that round will be considered equal. In all instances, a DNF will score higher than a DNS.
26. In the top 2, if both crews record equal times they shall have a run-off in the same order as before, to determine the winner. If necessary, this process shall be repeated until a result is achieved.

## **902 - RULES FOR CIRCUIT ENDURANCE CATAMARANS CHAMPIONSHIPS**

### **1. ORGANISATION**

All races will be controlled by and remain the property of the UIM In cases where International regulations do not exist then the national authorities will judge according to the general spirit of the event, considering UIM circuit rules in groups 100, 200, 300 and 400. Any local rules must be accepted by the teams provided they are in the advance programme. The World Championship will be run 6 events maximum with the possible addition of a 7th round, if this one is outside Europe.

### **2. UIM COMMISSIONER**

A UIM Commissioner will be present throughout the event and the costs will be borne by the organising club. The club must make Hotel arrangements for all the nights that the Commissioner will be present. For events of more than 12 hours, for events of 24 hours of continuous, 2 Commissioners will attend, one of which is the senior, for events on a day regardless of the time, a single Commissioner. The UIM will decide on seniority.

### **3. CLASSES**

Catamarans classes: There will be three classes for the World Championship, based on the corresponding S classes.

- S1 meeting the technical and safety rules of F1
- S2 meeting the technical and safety rules of F2
- S3 meeting the technical and safety rules of F4

The classification can only be established if there is minimum 5 boats and 2 nations per event, per class the first event.

Catamarans must NOT run with V classes and Pneumatics

### **4. MACHINERY**

Only homologated single engines can be used. The engine block must remain the same as started. All other parts may be changed. All engine blocks will be marked one hour prior to the commencement of the race. More than one engine can be used in practice.

For the S2 and S3 classes, at a minimum, a standard ECU Box will be allocated to the last race's winner, second, and third place finishers and the best performer last year before the free practice and must be used during the Race.

During the 2022 racing season, Reed valve reeds for the S2 UIM Class are free. The use of aftermarket reeds for the S2 UIM Class is allowed.

For races in city the noise suppressor is mandatory (505.01).

### **5. HULL**

The hull as started is the only hull to be used. More than one hull can be used in practice providing it passes all scrutineering. Running repairs can be carried out to hulls at their own pit area. All major repairs must be inspected by the scrutineers before re-entry to the race.

### **6. BUOYANCY**

All boats must carry sufficient buoyancy to keep their boat afloat.

## 7. FUEL

Fuel for racing must be provided by the organisers to a minimum standard of 95 RON Unleaded fuel. All competitors must use the fuel supplied by the organisers at cost as indicated in the advance programme, any competitor failing to use this fuel will be disqualified. No race fuel can be stored at the boat pit position. All boats must be refuelled at the fuelling depot. Each pit area may have a maximum of 25 litres stored in a shock proof container and carry the race number of the boat. The sole purpose of this is for generators etc. and must not be used for the race boats except in the case where repairs to a boat necessitate the fuel tank being drained. In this case a max of 25 litres may be placed into the fuel tank of the boat to fire up the engine in the pits and to drive the boat to the refuelling station. The maximum amount of fuel that a boat can carry is 150 litres for Catamarans.

## 8. REFUELLING

The refuelling must be carried out at the refuelling station and with the engine off. No repairs of any kind can be undertaken at the refuelling point.

***Stationary fuel tank (as shown at the end of 902 section) used for refuelling must be fully operational and action of releasing/closing fuel filler must be checked during scrutineering procedure. No exchange of internal boats's tank is allowed at refuelling station.***

## 9. FUEL DEPOT

All personnel entering the fuel depot must not carry the following: Cameras: Mobile Phones: Electrical items: Metal Objects: any device that can be ignited i.e. Lighters. All personnel must have rubber soled shoes.

## 10. NAVIGATION LIGHTS

Boats racing during night hours must have navigation lights as follows:

Single Green to Starboard min 5 watt or analogous LED.

Single Red to port min 5 watt or analogous LED.

Two sets of White lights separate installed to the stern of the boat, minimum 5 watts each or analogous LED, with back-up battery supply.

Two spot lights minimum to the front of the boat 36 watts minimum or analogous LED. These lights must not be more than 2 metres from the front of the boat.

Boats racing during day time and night time must have:

A high-power white led lamp, with 360 degree visibility and autonomous power (independent of the electrical system of the boat and a battery or batteries only for this lamp) will be placed at the highest point of the boat.

Power supply of the above mentioned emergency lights carried out over a separate electric circuit or from a separate battery.

For safety the boat must be equipped with an electric main emergency switch, accessible outside of the boat hull. Above mentioned switch should also stop the engine. Separate electric circuit for emergency lights should be operative when cutting the main electric circuit.

Drivers must carry a water-proof torch within the boat.

## 11. SLINGS

Each boat must carry its slings at all times if launch is by crane, whilst on the water and must comply with the safety rules and regulations of rule 205.12 of the UIM Drivers or mechanics must not ride in boats whilst the boat is being craned.

During the race a penalty of three laps will be assessed for each lap that a boat is racing without the required lifting slings.

## 12. FIXING EYE

A reinforced cockpit boat must be fitted at the bow with two mooring eyes, one at the top and one at the bottom, eye not less than 25 mm and not further than 250 mm from the front.

The fixing shall be strong enough to tow a boat partially submerged. A tow rope must be fixed. It must not be longer than the length of the hull.

## 13. RACE NUMBERS

In the event that two numbers are identical, then the team who enter first can keep their race number. The Scrutineer will issue a further number to the Team and it is the team's responsibility to replace the number. Race numbers must be on the race trailer. An organised will, if possible, notify any team of a clash of numbers prior to scrutineering. Number one is reserved for the winner of the UIM world championship.

For all night races the numbers shall be white on colored luminescent background Red Pantone 485 for class S3 / Blue Pantone 653 for class S2 / Green Pantone 355 for class S1.

For races during daylight application rule 206.02. All numbers must be fixed to both sides of the boat on the cell just behind the drivers head position.

## 14. NATIONAL FLAGS

All boats will carry the national flag of all competing drivers.

## 15. UIM PENNANTS

It is mandatory for all boats to carry the UIM Logo to both side of the boat.

## 16. SCRUTINEERING

All boats must be scrutineered before entering the water. It is mandatory for all drivers to be present and the Team Manager. All drivers must be able to prove that they fit within the craft as per UIM rules.

***All refuelling station (derrick) and fuel depot must be scrutineered before all boats entering the water.***

The O.O.D. and UIM commissioner will rule upon any such cases that infringe UIM rules on cockpits. Each pilot must have his own helmet and life support vest and this must be produced at scrutineering. All boats must be presented to scrutineers with pickle forks dismantled and boats must have a spare pair that must be presented to the scrutineers.

## 17. REPAIRS

All repairs with tools must be carried out within your designated pit area.

At or near the crane area, it is allowed to remove the boat and/or the engine cowling to make a visual inspection or manual, minor adjustment without the use of tools.

## 18. DURATION

The race will be for a minimum time period of 6 hours and maximum time of 24 hours continuous racing (see Part 34 also).

## 19. THE CIRCUIT

The overall shape of the circuit is not binding but must not be less than 2000 metres, and a maximum of 6100 metres.

All circuits must be registered with their N/A and with the UIM according to the rule Water Registration (106.02). The turn buoys will be divided into each class so as not to have boats in different classes turning on the same turn buoy. For the catamaran classes, 2 distinct circuits will be set up, exterior circuit for S3 up to 1050 ccs and interior circuit for S1 and S2. There must be at least 750 metres between the main turn buoy.

***In case of distinct, co-existing courses any occasional changing the designated for class course to the other one is not allowed (apart of entering/leaving the race) and penalty is 1 lap per each wrongly taken buoy.***

## 20. TURN BUOYS, AND OTHER BUOYS OF THE RACE COURSE

Turn buoys will be of a single colour either Orange or Red unless there are turns of both left and right then for left hand turns the buoy will be Orange and for right hand turns the buoys will be yellow. Destroying a turn buoy or other buoys of the race course - the cost of replacement will be charged to the offending team. Maximum cost 250 Euros per buoy + penalties (ARTICLE 38). Each turn will have 2 turn buoys.

## 21. ENTRIES

All entries must be on the organising club's official form and entries must be sent in by the date as requested. Late entries may be accepted providing all paperwork is in order and that their inclusion does not affect the water capacity as homologated. Entry fee for the championship may be charged. Late entries may be fined.

## 22. VALIDITY OF DRIVERS

All drivers must be in possession of a current licence issued by his N/A for the class of boat that he wishes to race. He must also have the N/A permission to race. All other aspects refer to UIM rule 120. A driver must also have a current immersion training certificate if required by the UIM for that class.

## 23. INSURANCE

Any driver who does not carry insurance to meet the requirement of the country in which they are racing, will have to pay, per boat, the required amount to a maximum of 190 Euros.

## 24. TEAMS

For races up to 12 hours there must be a minimum of two pilots and a maximum of 4 pilots, and for races from 12 hours to 24 hours there will be a minimum of 3 pilots and a maximum of 4 pilots and 5 pilots for the Class 1. Teams may practice more than the required number of pilots providing they have all paper work and licences in order. Team managers must notify the Control, 1 hour prior to the race as to their final pilots names and no alteration of the pilots list will be accepted for whatever reason. Failure to do so will lead to D/Q of the team. A pilot must not drive continuously for more than 2 hours. Any laps over the period will not be included. Minimum rest period for drivers is one hour.

If, during the race, a boat is immobile due to a technical problem, a repair or an accident, the pilots must sign the time management sheet of start and finish of the relay so as not to exceed the maximum allowed driving time while the boat is immobilized, and do the same for the resumption of the relay.

## 25. TEAM MANAGERS

All entries must have a Team Manager who must not be a pilot. In a case where there is more than one boat in a team then the Manager can represent all entries in that team. All penalties and other race documentation at the race site will be forwarded to the Team Manager. The Team Manager must be present at all meetings and scrutineering. It is mandatory that each boat is equipped with a radio and have a designated radioman during the briefing. the organizer must provide a placeholder radioman.

## 26. ADVANCE PROGRAMME

The organisers of the race will forward the advance regulations to all N/A's in English and their own language within 60 days of such race. All aspects of the advance regulations will have at least all those details as listed in UIM rule 202.

## 27. DRIVERS MEETING

It is mandatory for all drivers and Team Managers to attend driver's briefing. It will be in English and the language of the majority of the drivers present and held after scrutineering and at least one hour prior to practice.

## 28. PRACTICE

All new pilots to the course must complete at least 2 laps of practice.

## 29. STARTS

The start will be a flying start behind a pace boat. The signal to start will be via a Green flag.

## 30. FINISHES

The finish of the race will be after the lead boat has completed the time duration. This will be denoted by a chequered flag flown from control and the final positions will be at the time the other boats complete the required time period.

## 31. POSTING OF POSITIONS

Positions will be posted every half hour (first hour ) for the first 2 hours then hourly and every half hour for the last 1 hour.

## 32. CLASSIFICATION

The finish is shown to a driver by waving a black and white chequered flag. All present boats on water will have 10 minutes to cross the line of arrival.

To be classified as a finisher and to gain points you must have completed at least 40% of the class winner's laps and take the chequered flag. Boats not running but complete at least 90% of the class winners distance will be scored after all boats that take the chequered flag.

## 33. POINTS

Points will be awarded in each competing class as follows

1st	20	9th	7
2nd	17	10th	6
3rd	15	11th	5
4th	13	12th	4
5th	11	13th	3
6th	10	14th	2
7th	9	15th and onwards	1
8th	8		

A driver who participates in all rounds of the World Endurance Championship will be credited with 5 bonus points at the end of the championship.



### 34. INTERRUPTED RACE

A race that has to be curtailed for one reason or another and it is impossible for the race to recommence then points will be awarded as follows:

Up to 25% of race time 25% of points,

50% of race time 50% of points,

75% of race time 75% of points,

Over 90% full points.

The responsible boat of final stopping of race does not score points.

If a race is interrupted and can be recommenced within a reasonable period of time then the recommencement procedure will be as the start of the race less completed time. The time period remaining will be the total race time less 15 minutes and less completed time. The distance covered by each part of the race will be added together for the final result. The distance covered, the lap prior to the stoppage will be the laps taken. If the race has to be brought under a reduced speed then the pace boat will take the boats round in order there will be no overtaking. The restart will from the pace boat.

### 35. PRIZES

The UIM will provide Gold, Silver and Bronze medals at the completion of the series of races and the Champions will receive their medals at the last race. The organisers will provide trophies for the first three in each UIM class at each event. Prize giving must be within one hour of the completion of the race or, if protests are being conducted then it will be 30 minutes from completion of protests.

### 36. RESULTS

The results will be forwarded to the UIM offices within 24 hours of the completion of the event.

The general classification will be drawn on additional points of all rounds per pilot(s).

In case of an ex æquo the points obtained in the longest endurance race will determine the winner(s) (there could be various ex æquo positions if it concerns one same team).

In all events, the pilots will be classified and not the boats.

### 37. POST INSPECTION

The first three boats in each class will render themselves to the "park closed" for inspection immediately after the end of the race. Any boat failing to do so will be D/Q from that race. The only persons allowed in "park closed" are OOD, race technical inspectors, the UIM Commissioner, the drivers, the Team Manager and two mechanics. No other personnel are allowed.

### 38. PENALTIES

Any sanction against a driver (Yellow cards or disqualification) will be reported to the UIM. Should a driver be disqualified from that event under any rules of the UIM then the team may continue providing they have the minimum number of drivers. All other penalties will be reported to the Team Manager and displayed at race control.

Fuel infringement	4 laps
Race infringements	3 laps
Light infringements (after 2 laps of notification)	no laps will be scored.
Craning infringements	4 laps
Failure to attend scrutineering or drivers briefing	5 laps
Flag Infringement	3 laps
Priority of boats	5 laps
For missing a turn buoy or other buoys of the race course	1 lap
For hitting a turn buoy or other buoys of the race course	no penalty
For dislodging or destroying the first turn buoy or other buoys of the race course	3 laps
For dislodging or destroying the second turn buoy or other buoys of the race course	5 laps

### 39. PROTESTS

The Team Manager on behalf of his driver can make a protest. No collective protests will be accepted. They must be written in English with full details and, if appropriate the UIM rule.

The fee for a protest is fixed at 150 Euros, and for a protest against an engine is fixed at 380 Euros. Protest will be heard if possible within one hour of the protest being accepted and the result of any such protest will be given to the Team Manager and driver if possible. If a protest is upheld and laps have been deducted at the next posting of positions the laps will be re-introduced. If a protest comes within the last hour of racing then the protest will be heard as soon as possible and the final result will be not be posted until the protest has been heard. Protest on the final results must be made within half of one hour.

All protests according to rule 902.38 (Penalties) and "driver against another driver" must be handed to the Race Secretariat within one hour after pilots changing.

### 40. YELLOW/RED CARDS

Yellow cards can only be given by the O.O.D. or the UIM commissioner for offences on the water. They must be issued to the Team Manager or the driver on the official UIM form. Other offences are covered within rule 406.06 of the UIM.

### 41. APPEALS

Appeals against any protest not upheld see UIM rule 405.

### 42. BOATS BROKEN DOWN ON COURSE

Any boat that breaks down on the course cannot refuse a tow and must be towed in the direction of the course, unless derogation is granted, if the width of the water level allows this tow in full safety. This must be specified on the advance program. It is forbidden to be towed against the race direction on the race course.

### 43. PRIORITY OF BOATS

Rescue and pace boats have priority at all times. Entering the pit land and refuelling lane must be done at reduced speed and no overtaking unless a boat has become stationary. All boats entering the pits or refuelling area have priority over those departing.

### 44. RESCUE

A safety boat is always on the circuit with divers every 300m. You also need tow boats every 300m permanently on the circuit. There must be at least one rescue boat every 1000 metres capable of carrying a stretcher or that the boat must be a drop front dory (according to define the circuit).

### 45. PACE BOAT

It is mandatory that a pace boat be launched ready for use throughout the duration of the event and should there be a need for the race to be brought to a much reduced speed, then the pace boat will lead the leading boat flying a yellow flag until such time as the course is clear to race. All boats must remain in the order that they are in with no overtaking permitted (except classes S1 and S2 that can double the S3). When the race is due to be restarted the yellow flag will be dropped and the green flag raised. When the pace boat marshal is happy that all is in order to restart he will drop the green flag. This is the only signal to recommence racing. The boat refuelling under the pace boat is permitted, except set the briefing. It can leave the refuelling pontoon after the last boat in the race.

### 46. CRANES

In the event of a crane being used for launching there will be a minimum of one crane per 15 boats. If launching is by slipway then one launch vehicle per 15 boats. The slipway must be large enough to allow the number of launch vehicles to work at the same time.

### 47. FLAGS

Red:	Race terminated return to the holding area and await instructions
Yellow:	Danger on circuit,
Yellow:	Pace boat on circuit - no overtaking and reduce speed,
Black:	With race number fixed - driver to return immediately to the pits,

A boat having received a black flag has 3 laps maximum to exit the race course. Any laps done after the initial 3 laps will not be counted.

Chequered black & white:	Race completed,
Green:	Race commenced/recommended.

### 48. PUBLICITY

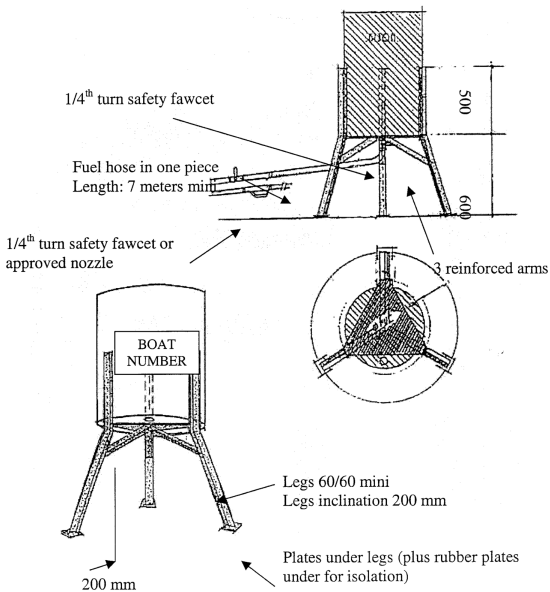
The organising club and national authority can request that any offences advertising or any that conflicts with the sponsor or sponsors may request it to be covered throughout the duration of the race. All other aspects - see rule 203.051.

### 49. MEDICAL COVER

The minimum cover for the duration of the race and practice is for two ambulances on station at all times and two doctors, one to be trauma trained. It is advisable to have two stations.

## 50. DRUG TESTING

All drivers can be subjected to drug and alcohol tests. Any refusal will be deemed as a failure and the drive disqualified. Any tests that prove positive, the drive will be disqualified and reported to the UIM All other aspects - see rule 205.02.02.



## **903 - GRAND PRIX HYDROPLANE CLASS**

### **GENERAL**

These rules are intended to provide specific requirements relating to the Grand Prix Hydroplane class. Otherwise the general rules of the UIM Circuit rulebook and the Race Organiser apply. Class designation letters shall be "GP".

### **903.1 - HULL**

#### **903.1.1 - Dimensions**

This class shall be for hulls of the hydroplane type with a minimum length of 6.4 m (21 ft) excluding projections that are not part of the original hull. Maximum boat size shall be 8 m (26 ft) long x 3.96 m (13 ft) wide. There shall be no maximum width for the tunnel. The "box style" method of measurement must be used. i.e., the boat plus all projections must fit into a rectangular "box" 8 m long x 3.96 m wide. No monotype hulls will be accepted.

#### **903.1.2 - Weight**

The minimum weight for boats in this class shall be 1032 kg (2275 lbs) for normally aspirated engines and 1123 kg (2475 lbs) for boats using a supercharger. These weights shall be measured when a boat finishes a heat. Boats must have all compartments drained of water. The residual fuel, oil, etc. is permitted.

#### **903.1.3 - Cockpit and Canopy**

All Grand Prix boats must have a reinforced cockpit and full canopy built to UIM specifications (per rule 509). All boats, and cockpits installed after June 21, 2014 must meet a minimum test standard of 5000 Newtons. A working escape hatch on all boats built after 2005 must also be provided.

### **903.2 - ENGINES AND DRIVE SYSTEMS**

#### **903.2.1**

Engines shall be automotive or marine, cast iron or aluminium, 4 cycle, 2 valve per cylinder, internal combustion type with a maximum displacement of 8.4 litres (513 C.I.D) with no allowance for over size. Superchargers and turbochargers are allowed without displacement penalty. Engines under 6.4 litres (392 C.I.D) must be supercharged. After market engine blocks are acceptable. A single speed gear box (transmission) is allowed. No multiple speed gear boxes are permitted.

#### **903.2.2 - Fuel Shut-off Device**

A positive fuel and/or electrical shut-off switch must be fitted to the left hand side of the cockpit and be suitably identified.

#### **903.2.3 - Drive**

Propulsion must be by one underwater propeller. Out drives are not permitted. Cavitation plates and drive shafts shall not be adjustable while boat is underway, however aerodynamic wings may be. All rudders, rudder brackets and skid fins must meet the Grand Prix organiser's standards of integrity and must be inspected by the technical inspector(s) prior to every event.

#### **903.2.4 - Rudders**

The hardware material for rudders is to be stainless steel heat treated # 17-4 or better. Skid fins (and rudders) are required to be minimum 19 mm (3/4") aluminium # 7075 or heat treated 4140 or 4130 steel.

Brackets as a minimum must be made from # 6061 or # 7075 aluminium. Stainless steel # 17-4 and steel # 4130 may also be used. Also alloy 2024 # T351 has good elongation and ductility of high grade aluminium, comprises of copper - magnesium -manganese alloy may be used.

### **903.2.5- Fire Suppression**

All Grand Prix boats shall be equipped with a functional on-board compressed gas or equivalent foam fire suppression system with distribution nozzles in the engine compartment, half of which must be discharged in front of the engine. The minimum weight shall be 3.0 kg capacity. The system must include a manual triggering device operable by the driver on-board the boat or by a helper outside. The location of the outside device must be indicated by the "E" in a red circle. The system shall be inspected and approved by the technical inspector(s). Exceptions to this rule shall only apply to non-GP class boats or Series boats running with GP class boats in a GP class event, as long as the non-GP class boats meet the fire suppression rules of their particular class or series. Each boat trailer in the working pit shall have a minimum of 3.0 kg capacity dry chemical approved fire extinguisher available for easy access.

## **903.3 - INSPECTION OF BOATS AND ENGINES**

### **903.3.1**

No boat shall be allowed to start in a GP class event until its hull and engine(s) have been inspected for compliance of all rules pertaining to safety and eligibility. A Measurement Certificate issued by the National Authority must be produced at inspection.

### **903.3.2 - Sealing of Engines**

All engines, following inspection, must be sealed using the following procedure; engines shall be legibly numbered in an accessible location on the block and a hole drilled in an accessible webbing for attachment of an identification seal.

### **903.3.3 - Random Checking**

Engines may be randomly checked at any time to determine maximum capacity and other eligibility.

## **903.4 - CONDUCT OF RACES (RECOMMENDED FORMAT)**

### **903.4.1**

Recommended formats are closed course time trials and multiple heats of 3 or 4 laps over a 1-1/4 mile course, except where it is confirmed impossible or impractical by the race committee. Course size must be registered with the Grand Prix Club thirty (30) days before a race and remain unchanged. A Minimum of 1 hour must be allowed between heats where the same boats compete. In all qualifications and finals, lanes must be established approximately 150 m (500 ft) (marked by a buoy) before the entrance of the upper turn.

### **903.4.2 - Day One**

The first day of racing will consist of time trials and one set (heat 1A and 1B) of competition heats. Competition heats will be three (3) laps. A minimum of two hours must be allowed between the completion of the time trials and the competition heats. Competition in these heats will be formulated per the Grand Prix referees' agreement with the local race director.

### **903.4.3 - Day Two**

The second day of racing will consist of time trials, one set (heat 2A and 2B) of competition heats, semi-final and final event. Competition heats will be three (3) laps. A minimum of two hours must be allowed between the completion of the time trials and the competition heats. Competition in these heats will be formulated per the Grand Prix referees' agreement with the local race director.

#### 903.4.4 - Semi-Final Event

The semi-final will be held a minimum of two hours after the completion of the competition heats. Places seven (7) through fourteen (14) from the time trials will compete in this event. Lane choice will be determined by a draw from a hat. This will be conducted by a member of the Race Committee. The seventh, eighth and ninth qualifiers from the time trials will draw for lanes, one two and three. Seventh place will have first draw. The tenth, eleventh and twelfth qualifiers will draw lanes, four, five and six. The first and second place boats from the semi-final qualify for the final event as trailers. The remaining finishers from the semi-final are on standby for the final.

#### 903.4.5 - Final Event

The top six (6) qualifiers from the time trials qualify for the final. Lane choice will be determined by a draw from a hat. The first, second and third qualifiers from the time trials will draw for lanes one, two and three. First place qualifier will have first draw. The fourth, fifth and sixth qualifiers will draw for lanes four, five and six. The two remaining positions for the final will be the inside and outside trailers. Trailers' positions are rewarded based on their order of finish from the semi-final event.

#### 903.4.6 - Stand-by Entries

Stand-by entries shall be allowed and be classed in the order of performance provided they have completed one (1) lap in the qualifying heats. The stand-by entries will be notified by the Referee before the five (5) minute signal if eligible to race.

If a stand-by boat gets into the final, Grand Prix will pay the boat he replaced 8th place prize money. "Stand-by" entries shall be allowed and be classified in the order of performance. No stand-by boat in the water. If requested

by the members and if time permits, a five minute-to-the-five warning may be given by the Referee prior to the start of all heats. The number of boats in the water at one time shall not exceed the available docking.

#### 903.4.7 - Finish of Race

Once the lead boat receives the chequered flag, all boats will be considered as having completed the race when they receive the chequered flag at their next crossing of the start/finish line.

#### 903.4.8 - Course Infractions

For safety reasons, boats may cross the starting line before the last thirty (30) seconds prior to the official start of the race. All boats crossing the starting line during the last thirty (30) seconds before the official start will be assessed a two (2) minute penalty.

Holding/changing lanes: All competitors must hold their assigned lane through the completed first turn of the first lap of competition. Changing of lanes cannot occur until the boat has passed the second buoy (exit pin from the first turn) and the six boat minimum requirement is met.

#### 903.4.9 - Prize Money

Prize money and points will be awarded as scheduled in the Advance Programme.

Drivers and/or owner or one of their representatives must be present at the event prize giving function.

#### 903.4.10 - Back-up Boat

A driver may accumulate points with only one boat per event.

### 903.5 - DRIVER REQUIREMENTS

#### 903.5.1 - Immersion Certificate

All drivers must hold a current certificate of underwater training as outlined in rule 205.05.

**903.5.2 - Driver Approval**

Any driver who drives a boat for the first time in competition shall not hold the pole position at the start and first turn in at least one heat. The referee shall appraise his performance and, if satisfactory, waive further restrictions.

**903.5.3 - License**

Final approval of all drivers shall rest with the decision of the driver's National Authority. The Driver's National Authority must confirm the status of each driver in written format. A copy of all activities for each driver will be maintained with the Race Committee.

**903.5.4 - Medical**

All drivers must have an annual medical examination as determined in Rule 205.01 including an electro cardiogram performed under stress as per the requirements for a Super Licence determined in Rule 205.04.1

**903.5.5 - Clothing Protection**

It is mandatory for all drivers to wear protective clothing as determined in Rule 205.11. Such clothing must have tight fitting cuffs and ankles and also have fire retardant properties. Gloves shall also be worn.

**903.5.6 - Consumption of Alcohol**

The consumption or use of any alcohol in the working paddock or pit areas shall be expressly prohibited until after 30 minutes after the last heat of the day or inspection is completed, which ever is later. Specifically, drivers shall conform to Rule 205.02.02 regarding doping test and consumption of alcohol.



## **904 - INBOARD RACING DISPLACEMENT CLASS RULES**

### **1. CLASSES**

RD-∞ cylinder capacity of motor to infinity.

RD-6000 maximum cylinder capacity 6.0 liters

### **2. HULL**

The hull shall be displacement or monoplane type in which the continuity of the portion of the hull immersed, at rest, in racing trim with the driver on board, shall not be interrupted longitudinally or transversely by any form of break, step or device of construction or hydrofoil, that would provide multiple planing surfaces. Hulls are permitted to be either mono V hulls or flat bottom hulls.

The term hull shall include all additions and attachments below the waterline with the exception of the shaft, strut, propeller, rudder, fin and such that are usual and necessary. Cavitation plate, trim tabs and after planes that are fixed or adjustable whilst underway shall be permitted.

Lap strake or reverse lap strake construction may be used provided the immersed portion of the strakes (planks) be approximately parallel with the centre line of the hull and the depth of the strake (plank) be no greater than 35 mm.

Planing strakes (planks) unless continuing to the tuck (transom) must finish on an angle being not less than 450 mm from the point of commencement of the angle to flush with the hull bottom and the angles not to be concave to the hull bottom.

Non-trip chines with a rise of not less than 75 mm in 300 mm, vertical sided keels and skid fins shall be allowed.

At the option of the owner or the builder, that point where the planking meets the non-trip chine can be rounded or left square regardless of the thickness of the planking.

The depth (thickness) of the strake (plank) is to be taken by stretching a wire or similar material around the bottom of the hull, at right angles to the centre-line, on the point being measured.

The depth (thickness) is to be measured at right angles to the hull surface and this depth must not be more than 35 mm at any point.

The length must be measured between perpendiculars at the foremost and utmost rigid part of the hull.

Any extending parts such as rubbing strakes, fenders, stabilizing or trim tabs, rudder, skeg or cavitation plate, are not to be included in the length measurement.

### **3. WINGS**

Only Infinity class hulls fitted with forced induction (blown/supercharged) engines are permitted to use wings.

Only single or dual plane wings are permitted.

All wings must be mounted directly to the engine or the engine bearers.

The wing including the side fins/spill plates should be a maximum of 450 mm higher than the highest point of the boat or engine and must not extend beyond the extremities of the hull at the mounting point.

The suitability and adequacy of the wing is the responsibility of the owner, who should be satisfied that it is competently designed, manufactured and fitted so as to remain fixed and operational at high speeds.

The wing may be adjustable while the boat is in motion.

### **4. MINIMUM DIMENSIONS**

CLASS	Length	Reinforced Cockpit
RD-∞	5.2 M	Mandatory (5,000 N)
RD-6000	5.2 M	Mandatory (5,000 N)

The length must be measured between perpendiculars at the foremost and aftmost rigid part of the hull.

Any extending parts such as rubbing strakes, fenders, stabilising or trim tabs, rudder, skeg or cavitation plate, are not to be included in the length measurement.

The minimum weights mentioned here are the weight of a complete rig weighed directly after the race including driver, personal safety equipment, residual fuel but without residual water.

## 5. MACHINERY

### CLASS RD-UNLIMITED

The motor is free.

The motor must be fixed inside the hull.

The power transmission train must pass through the structure of the hull.

All modifications are allowed.

All propelling forces must be directed in and against the water.

An electric starter and battery must be on board.

The transmission is free.

### CLASS RD-6000

Maximum capacity of motor is 366 cubic inches.

Stroke/Bore is of any type that meets the cubic inch capacity.

Camshafts to be in engine block (No overhead camshafts).

Cylinder heads must be of over rocker design, push rod articulated and 2 valves per cylinder. No pneumatic springs allowed. Must be a conventional valve spring

Intake system must be naturally aspirated (no forced induction supercharged or turbo charged).

## 6. FUEL

### CLASS RD-UNLIMITED

The type of fuel will be Gasoline or Methanol/Ethanol.

Nitrous oxide will be permitted. Nitro Methane and any other chemical supercharging will not be permitted.

### CLASS RD-6000

All fuel must be methanol or petrol based, as supplied by the promoter. (no additives allowed).

## BOAT SAFETY

### 904.1.2

A safety collar on the propeller shaft, within 0.5 inches of the leading end of the strut and a safety collar within 0.5 inches of the shaft log assembly, is mandatory on all runabout classes. Safety collars must be configured so they will prevent the shaft and propeller from sliding back and hitting the rudder should the thrust bearing come apart or loose on the shaft. The safety collar must have two set screws or be of the split-type configuration. If placed forward of the thrust bearing, the collar must be larger than the bearing.

### 904.1.3

V Drives must be fitted with a Whirlaway (Prop release) and a retainer type device is fitted between the clutch housing and log, to stop the clutch housing from moving back so the prop or prop shaft does not move back far enough to hit the rudder, due to bolt failure of the clutch housing or gearbox. The drive shaft must pass through this retainer type device with minimum clearance.

The owner/Driver is entirely responsible for the effectiveness, suitability and adequacy of the retaining device.

### 904.1.4

All boats must be equipped with a positive return throttle, insuring that the throttle plate returns to a normally closed position when throttle pressure is released. Springs should be mounted at throttle shaft assembly.

All boats must have suitable flotation which will float the hull, motor and driver in a swamped state. It will be the responsibility of each owner to verify if his craft's flotation is adequate. It is recommended that flotation be placed in location to help upright capsized hulls. Flotation should be provided in at least 4 separate flotation unit.

## NON-DESTRUCTIVE TESTING

### 904.1.5

(NDT), such as magnetic particle, dye penetrate or other processes, is recommended regularly for propellers, shafts, couplers, rudders, fins, brackets, struts and other critical hardware. Following an accident, it is mandatory that NDT be performed prior to competition

## AIR SYSTEM

### 904.2.1

A full-time onboard air system is mandatory for all boats.

### 904.2.2

The Drivers mask must cover the driver's nose and mouth and be designed to be watertight. The mask must be attached in such a way as to prevent its being dislodged or removed inadvertently and must be worn by the Driver anytime the boat is under power.

Driver and crew members must have a valid recognised diving qualification.

The air supply hose from the tank to the driver mask/ mouthpiece hose connection shall be of sufficient length to allow the driver to move clear of the farthest side or front of the hull measured from the center of the steering wheel.

An ambient air valve is required. A quick release pressure sealing coupler shall be used to connect the air supply hose from the tank (first stage regulator) to the driver mask hose (second stage regulator); the driver mask hose length shall be 25 cm (min) to 91 cm (max) to the connection.

A female coupler fitting shall be attached to the air supply hose from the tank; the male coupler fitting shall be attached to the driver mask/mouthpiece hose. A tee block with two male coupler fittings, attached to the driver mask/mouthpiece hose, is allowed. Parker part number SH1-62 / SH1-63 (or other manufacturer interchange) is the accepted design sealed coupler assembly; stainless steel material is highly recommended, brass is an acceptable alternative.

Each crew member in full race attire & race position must physically demonstrate to the scrutineer that they are able to locate and use their Air Supply Equipment.

Competitors & crew members are responsible at all times for maintaining their equipment and ensuring that it complies with the rules.

### 904.2.3

All boats must carry a minimum of 30 cubic feet of air, regardless of mask type. All air delivery systems, whether permanent or part time, shall carry air in a vessel approved and certified for the delivery of breathing air.

All components of the air system shall be rated for use with compressed air and for the pressures to which they will be subject.

The air supply bottle must be securely fastened to the boat and switched on during all on-water activity.

Each air supply bottle must have a pressure gauge fitted that should be at least 5cm in diameter to allow easy reading during pre-race scrutineering and by crew members on-board.

Each air supply bottle must show 'full' in order to pass pre-race scrutineering.

## CAPSULE TRAINING

### 904.2.4

All capsule Drivers are required to successfully complete a National Authority Approved Inboard Capsule Training Program.

Before racing in a craft with restraint systems, all onboard crew must have passed in the last fourteen months, an immersion training in a restraint system to ensure that they can exit a reinforced cockpit crew compartment successfully.

Prior to taking the Immersion training, all onboard crew must have a valid scuba certificate or have received suitable training. This alternative training should be approved by the National Authority.

It is mandatory to wear a Frontal Head Restraint device during Cockpit Evacuation / Immersion Training. Self-removal of an FHR forms a part of the Immersion test training.

An immersion Certificate to certify the passed training, showing the expiry date, not to exceed 14 month, must be delivered by experts recognised by a National Authority.

A model for the certificate and instructions of how to perform immersion training are available at the UIM Secretariat.

### 904.2.5

In addition, at race sites or other location, a referee or inspector may require the Driver to:

- Demonstrate that he can adequately extricate themselves from a safety team test cell, both on land and under water.
- Demonstrate that he can extricate themselves from the cockpit of the boat he intends to Driver prior to any event.
- Complete any further test, including a driving test, under the supervision of the Inboard Racing Commission or their designee, to demonstrate that the said person can participate in an event without representing an unjustifiable risk or endangerment to themselves or others.

## CAPSULE

### 904.3.1

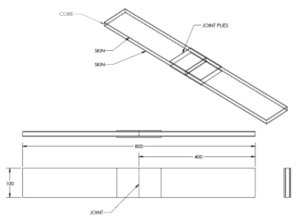
All hulls must be fitted with a reinforced cockpit with a minimum strength of 5000 Newtons, 3000 Newtons below deck.

The reinforced cockpit shall be of a closed type design with a minimum of one opening hatch and constructed to a similar strength as the running surface of the boat. This area must be the sides, floor, decking, and bulkheads fore and aft. All new cockpits built after January 1, 2015 shall be built by a UIM registered cockpit builder. Constructors wishing to be registered must submit panels for test according to the following standards. Constructors meeting these standards will be registered as UIM registered cockpit builders.

## UIM INBOARD DISPLACEMENT CLASS COCKPIT TEST STANDARD

### Sample Construction Requirements

- a. Sample quantity must be 3, one of which must include a sample of the joint/bonding of the cockpit parts, transverse to the length of the sample.



- b. Trimmed sample size must be  $100 \text{ mm} \pm 1.0 \text{ mm}$  wide x  $800 \text{ mm} \pm 5.0 \text{ mm}$  long, with the width being parallel.
- c. For fibre orientation the 800 mm length is to be parallel with the centerline of the boat.
- d. Sample must be laminated on a flat surface using the same manufacturing process, materials, and fibre orientations as the intended homologated cockpit construction.
- e. The sample must have a uniform thickness with no core crushing along any edges.
- f. The sample must have one moulded face and the other face being unmoulded, the moulded face will be taken as being the external surface of the cockpit during testing.
- g. The sample must be representative of the thinnest lay-up of the cockpit/canopy (excluding the various flanges for windshields, hatches etc.).
- h. The sample and cockpit must be manufactured using balanced or unbiased materials.

### Sample Test Method

- a. The sample will be supported across the full width perpendicular to the 800 mm edges by two parallel 25 mm Steel bars at a distance of 500 mm apart. The load will be applied equally through two 25 mm Steel bars, each a distance of 167 mm parallel from each support.
- b. The moulded face of the sample will have the load applied and the unmoulded face will support the sample.
- c. The load will be applied at 0.4 mm/sec and the deflection will be measured at the two 25 mm Steel bars applying the load within 2 minutes

### Sample Test Requirements

- a. The sample when loaded with a force of 5000 Newtons must have no more than a maximum deflection of 25 mm without the sample failing.
- b. The sample weight in gm/sq m will be calculated, skin thickness and sample thickness will be measured to enable inspection and comparison of damaged homologated cockpits/canopies.
- c. Further non-destructive test analysis methods may be used to compare test samples with registered cockpits during the life of each cockpit/canopy.

### Sample Manufacturing Information Requirements

- a. Ply laminating sequence (stating which ply is the moulded face).
- b. Ply materials.
- c. Ply weave styles
- d. Ply material weight in gm/sq m (dry weight ie. Without resin)
- e. Ply orientation (where OD is parallel with the 800 mm edges).
- f. Core material and density in lbs/cu ft or kg/cu m.
- g. Manufacturing method (stating vacuum, pressure, and temperature).
- h. The completed questionnaire for circuit cockpits (available on the UIM web site).
- i. Samples as per sample construction requirements must be sent to the following addresses:

For Australia a testing facility approved by the Australian Power Boat Association may be used. For other countries contact the UIM office for an approved testing facility.

Mandatory standards for all restraint capsules include:

The Aft panel (bulkhead) above the deck line of the capsule built after August 2014 must be of a convex shape in both the vertical and horizontal planes. The minimum acceptable curve in the plan view shall be 100mm. Rule a straight line from corner to corner of the capsule at deck line. The centerline of the capsule must project at least 100mm aft of this line.

The curvature in the vertical plane must also be a minimum of 100mm. The aft most point of the capsule must not be above the deck line in any particular hull.

This part of the capsule may be an add on panel but must be built of the same materials as the test panels registered with the UIM and laminated, glued or bolted into the capsule at the time of the capsule construction, if the manufacturer does not wish to alter his moulds.

Any bolts passing through this bulkhead, must be hard spotted for location of seats, seat belts and, or lifting eyes. I.e. the coring must be removed, at least bigger than the corresponding fender washer of the bolt and replaced with a material that cannot be crushed when the bolts and nuts are tightened.

- Openings for restraint harnesses, wiring, cables, hoses, etc. must be kept to a minimum. The use of grommets or other types of sealing devices are recommended around these openings.
- All canopies must have an external handle or hand hold opening.
- All boats must have a rollover lift bracket or eyelet permanently attached to the rear area of cockpit. The bracket or eyelet must have at least a 3/4" hole and be strong enough to support the weight of the boat should it need to be righted for rescue purposes.
- Positive air flow ventilation.

### 904.3.2

Right and left hand rear view mirrors are required on all boats.

### 904.3.3

All boats must have the official Inboard manufacturer's label permanently attached and visible inside the cockpit. It is the boat owner's responsibility that this label be present and legible.

Manufacturers will receive an acknowledgement from the Federation Inboard Racing Commission stating that the company is registered to build restraint capsules for the Inboard Category.

Upon submission to the UIM office through the Chairman, Safety Cockpit Committee, of the required completed questionnaire, sample information requirements, and the testing documents showing that the samples have achieved the required strength; the UIM will send an acknowledgement to the Manufacturer and add their name to the registered manufacturers on the UIM web site.

## SEAT BELTS

### 904.3.4

The use of an approved seat belt with a quick opening clasp is mandatory. Both the fastening design and condition of the belt is subject to inspection. Belts must meet the following requirements:

- Minimum width: 50 mm.
- The restraint system must consist of a minimum six strap six point mounting system.
- Minimum tensile strength: 8000 pounds (loop test).
- Polyester belt material is mandatory.
- Belt material to be as short as practical.
- Metal to metal quick release buckle.
- A high strength, highly visible lanyard will be attached to the release lever of the lever/latch system.

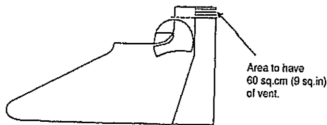
## HEAD PROTECTION

### 904.3.5

A minimum of 10 cm (4 inch) clearance above driver's head covering at least 50 % of the top of the helmet and a least 50 % of the side for the helmet with the driver's head in the furthest aft position as an integral part of the reinforced cockpit construction.

It is recommended that a minimum 12 mm (1/2 inch) 4 kg (9.1 lb.) ethofoam or other energy absorbing foam support completely around inside of helmet area to prevent injury from helmet hitting any part of the reinforced cockpit.

It is recommended that in an open reinforced cockpit opening(s) totaling 60 cm<sup>2</sup> ( 9 sq. inches) surrounding the driver's head be added to relieve the hydraulic affect.



## COCKPIT CANOPY

**CANOPY DESIGN** – Reinforced cockpits must be fitted with a canopy which must be constructed of materials of sufficient strength to provide protection. The lay up must be equal to the minimum lay up for that Class, with attention to be paid to the strength of all edges.

For reinforced cockpits manufactured after 31st August 2005 – the hatch must have a flange to ensure that the lid cannot collapse into the cockpit in the event of an accident.

**CANOPY APERTURES** – Fixed canopies should have the entry/exit aperture located directly above driver's head. The aperture must be unobstructed to facilitate easy exiting. The aperture opening should be at least 0.50 m in length and 0.40 m in width. The canopy aperture should be cut with all corners having a radius of 0.025 m minimum or 0.25 m maximum. The radius should be constant and have a smooth finish to relieve stress.

The canopy hatch must be constructed so as not to provide any impediment to the exiting of the driver when fully race fitted.

On any reinforced cockpit, provision must be made for the canopy to be opened from both inside and outside.

## WINDSCREENS

### 904.3.6

1. All windscreens will be shatterproof material. Polycarbonate or laminated polycarbonate/acrylic (fighter jet windscreen) of high optical grade with scratch resistant outer coating is preferred.
2. For Class RD-Unlimited, minimum thickness 10 mm
3. The preferred method of installing windscreens is by gluing. If the windscreens are not glued, the windscreen shall be affixed through-bolted utilizing bobbins/sleeves made of nylon, delrin, aluminum or other material so as not to directly cause clamping forces to the windscreen material by through bolts. Bolt spacing shall be no greater than 5 cm and shall incorporate the use of 6 mm diameter (minimum) stainless steel bolts. All bolts shall utilize stainless steel nylock or acorn nuts with washers. No bolt threads or sharp edges shall endanger the driver in the cockpit.
4. It is highly recommended that any bolt holes in the windscreen be reamed to minimize cracking. This is particularly important with acrylic material because of its notch sensitivity.
5. All outer edges of windscreens shall be protected from water intrusion leading to possible failure by the use of frames or filler material.
6. The above requirements are mandatory for all boats in Class RD-Unlimited after January 1, 2016.

## RESCUE SAFETY TEAM CRITERIA

### 904.4.1

The following are the standards for rescue safety teams working events.

- The name of the safety/rescue team selected to work each event must be listed on the race circular for events.
- Rescue personnel shall contact potential receiving hospitals prior to the event day in order to familiarize the facility with particulars about the event.
- The ambulance, emergency medical staff, and dive team and all rescue team members in attendance shall be dedicated to provide service to the race for the duration of the event, and will not be on call or otherwise responsible for other duties.
- The rescue team must have communication equipment sufficient to ensure adequate communication between rescue boats, race officials and the Race.

Rescue Director. The rescue boats shall have radio communications with the Officer of the Day, or his designee. Radio communications specific to patient condition shall be kept at a minimum. Rescuers should bear in mind at all times that radio frequencies may be monitored. Condition of patient shall only be discussed with the Officer of the Day.

## PERSONNEL AND STAFFING

An individual member of the rescue team must be clearly identified as the Race Rescue Director. He or his designee shall be the lead person at all rescue scenes and shall direct all rescue operations. He will take direction from and report to the Referee.

The Race Rescue Director shall meet daily with the Officer of the Day or his designee for instruction prior to beginning the day's events. The Race Rescue Director shall immediately advise the Officer of the Day if, in his/her opinion, any unsafe course conditions (including swimmers in the water, alcohol consumption on the course boats, underage children on course boats, lack of PFD use, debris on course, etc.) exist.

No heat shall be started at an Event in the absence of a licensed physician, registered nurse, paramedic, or an EMT in attendance. An ambulance will be authorized to transport injured individuals from the race course to the assigned hospital, and the medical attendant will be trained and authorized to use all the equipment in the ambulance.



There shall be a minimum of four divers certified by an accredited certifying agency present on the water at all times. Prior to each race day, divers shall familiarize themselves with driver safety equipment and structural characteristics of each boat. Divers shall be fully suited and ready to enter water at any time a race boat is present on the water. The divers may or may not be on the official rescue boat but cannot be on either of the turn judge boats.

## **PATROL BOATS AND RESCUE BOATS**

### **904.4.2**

There must be a minimum of two (2) designated rescue boats capable of carrying one or more accident victims in a supine position present and the craft shall be staffed and ready for use at all times when racing boats are under power. A patrol boat, properly staffed and equipped, may be used as a rescue boat. These boats should be positioned to minimize response time to an incident on the course.

### **904.4.3**

All rescue/patrol/turn judge personnel shall meet with the Officer of the Day, or his designated representative, for instructions prior to each day's racing.

### **904.4.4**

The operators and crews of all rescue/patrol/turn judge boats with the exception of divers shall wear personal flotation devices (PFDs) in the manner intended by the manufacturer, any time a race boat or their rescue boat is under power on the course. They must be fully informed by the Officer of the Day, or his designee, in signal flag use, driver hand signals, on how to conduct themselves, their position on the course, what to watch for, and how to respond in the case of an emergency. The importance of moving slowly to not create a wake should be stressed.

### **904.4.5**

A set of appropriate signal flags should be carried by both rescue and patrol boats. The Officer of the Day should ensure that all boat personnel are instructed in signal flag use.

### **904.4.6**

Two patrol boats as an absolute minimum and more if conditions warrant, are available for duty on the course at all times. Only authorized personnel shall man safety and/or patrol boats.

### **904.4.7**

No person less than fourteen (14) years of age, unless accompanied by a parent, will be allowed to be a member of a patrol or turn judge crew except UIM members being trained or functioning as a turn judge.

### **904.4.8**

Rescue boats may not be utilized for purposes other than rescue functions while race boats are on the water.

### **904.4.9**

When any race boat is on the course, each rescue boat staff shall consist of a minimum of two persons onboard consisting of at least one certified or licensed EMT-Basic capable of providing basic life support and one experienced

- Prying tool (minimum 12 inch) - one per rescue boat.
- 16-inch cable cutter - one per rescue boat.
- Rigid body immobilization device (such as Stokes basket, backboard, etc.) –at least one per course.
- A minimum of 25 to 50 foot tow rope with heavy duty quick connects such as snap hooks or carabiners at each end - per rescue boat.
- Equivalent of 20 lb. dry chemical (ABC) fire extinguisher - per rescue boat.
- Flares or pyrotechnic devices shall not be carried on rescue boats.

## **904.5.2**

### Medical Equipment per boat

- Body substance isolation devices.
- Airway kit including basic airway adjuncts, a bag-valve mask, and manual or mechanical suction
- Basic BLS trauma kit.
- Blankets and towels
- Liquid detergent for hand washing and fuel decontamination.

## **905 - RULES FOR CIRCUIT ENDURANCE PNEUMATICS AND V-CLASSES CHAMPIONSHIPS**

### **1. ORGANISATION**

All races will be controlled by and remain the property of the UIM In cases where International regulations do not exist then the national authorities will judge according to the general spirit of the event, considering UIM circuit rules in groups 100, 200, 300 and 400. Any local rules must be accepted by the teams provided they are in the advance programme. The World Championship will be run 6 events maximum with the possible addition of a 7th round, if this one is outside Europe, except pneumatics.

### **2. UIM COMMISSIONER**

A UIM Commissioner will be present throughout the event and the costs will be borne by the organising club. The club must make Hotel arrangements for all the nights that the Commissioner will be present. For events of more than 12 hours, for events of 24 hours of continuous, 2 Commissioners will attend, one of which is the senior, for events on a day regardless of the time, a single Commissioner. The UIM will decide on seniority.

### **3. CLASSES**

Engines that comply with EPA regulations will be allowed to compete with a 30% greater capacity in their corresponding classes.

V Classes: There will be 2 classes for the World Championship.

Class 1 Over 1050 cc and up to 3100 cc

Class 2 Up to 1050 cc

Pneumatics classes: There will be 4 classes for the WC and CC with low emission engines complying with 2006 EPA rules (as per homologation sheet);

PRE1 horse power of the engine - unlimited.

PRE2 horse power of the engine not more than 200 hp.

PRE3 horse power of the engine not more than 140 hp.

PRE4 horse power of the engine not more than 60 hp.

The classification can only be established if there is minimum 5 boats and 2 nations per event, per class the first event.

V classes and Pneumatics must NOT run with Catamarans.

### **4. MACHINERY**

Only homologated single engines can be used. The engine block must remain the same as started. All other parts may be changed. All engine blocks will be marked one hour prior to the commencement of the race. More than one engine can be used in practice.

For races in city the noise silencer is mandatory (505.01).

Use of power trim is allowed for pneumatics. The height of the motor must remain fixed while racing for pneumatics.

List of engines allowed for Pneumatics:

Class	Homologated engines	Volume ccm	Engines permitted for Endurance Pneumatics races	Volume ccm
PR1			Mercury 250 Optimax	3032
			Mercury 225 Optimax	3032
	Mercury 2,5 EFI	2582,2	Permitted (not low emission)	
Class	Homologated engines	Volume ccm	Engines permitted for Endurance Pneumatics races	Volume ccm
PR2	Mercury 200 XS (Optimax)	2526	Mercury Optimax 200 XS (20")	2526
	200XS(15")		Mercury Optimax 150	2526
			Mercury Optimax 135	2526
			Permitted (not low emission)	
	Yamaha Z 150P	2596	Yamaha Z 175P	2596
PR3	Mercury Optimax 90-115	1524	Mercury Optimax 125	1524
			Mercury Optimax 75	1524
PR4	Tohatsu M50D	698	Permitted (not low emission)	

All low emission engines are allowed if their displacement does not exceed 5 % of the maximum displacement of homologated engines for the identical classes.

All Mercury ProMax Series engines (not low emission) are allowed for PR1.

## 5. HULL

The hull as started is the only hull to be used. More than one hull can be used in practice providing it passes all scrutineering. Running repairs can be carried out to hulls at their own pit area. All major repairs must be inspected by the scrutineers before re-entry to the race.

For the Endurance Pneumatics hull is monohull and is per rule 567.

Rule 567.03 is not to be used for the Endurance Pneumatics.

Requirements to the hull minimum boat weights and length as follows:

Racing class	Length (min)	Width (min)	Weight (min)	Tube diameter (min)
PR1	from 5.60 m	2.00 m	800 kg	0.40 m
PR2	from 5.30 m	1.80 m	680 kg	0.35 m
PR3	from 5.00 m	1.80 m	580 kg	0.35 m
PR4	from 4.00 m	1.70 m	350 kg	0.30 m

To compensate different engine horsepower within identical class, dimensions (length, width) are minimal within the given boat class, the weight of the low emission engines powered boats however can change according to the engine horsepower at a rate of 3,5 kg/HP, but to be more than minimal weight of previous(lower) class.

If pneumatics tubes are not U-shape configuration, maximum length of plastic part of the tube must be no more than 15 % of overall length of the boat.

The ballast water tank is allowed only to compensate fuel consumption during the race. On post inspection it must be empty. The weight of water ballast is not included for calculation of minimum weight of the boat.

## 6. BUOYANCY

All boats must carry sufficient buoyancy to keep their boat afloat.

## 7. FUEL

Fuel for racing must be provided by the organizers to a minimum standard of 95 RON Unleaded fuel.

All competitors must use the fuel supplied by the organizers at cost as indicated in the advance program, any competitor failing

to use this fuel will be disqualified. No race fuel can be stored at the boat pit position. All boats must be refuelled at the fuelling depot. Each pit area may have a maximum of 25 litres stored in a shock proof container and carry the race number of the boat. The sole purpose of this is for generators etc. and must not be used for the race boats except in the case where repairs to a boat necessitate the fuel tank being drained. In this case a max of 25 litres may

be placed into the fuel tank of the boat to fire up the engine in the pits and to drive the boat to the refuelling station.

The maximum amount of fuel that a boat can carry is 100 litres.

The use of replaceable plastic tanks for fuel with the capacity of no more than 60 litres is allowed for Pneumatics.

For Pneumatics the maximum amount of fuel the boat can carry is as follows:

PR1 200 liters

PR2 200 liters

PR3 150 liters

PR4 60 liters

## 8. REFUELLING

The refuelling must be carried out at the refuelling station and with the engine off. No repairs of any kind can be undertaken at the refuelling point.

## 9. FUEL DEPOT

All personnel entering the fuel depot must not carry the following: Cameras: Mobile Phones: Electrical items: Metal Objects: any device that can be ignited i.e. Lighters. All personnel must have rubber soled shoes.

## 10. NAVIGATION LIGHTS

Boats racing during night hours must have navigation lights as follows:

Single Green to Starboard min 5 watt or analogous LED.

Single Red to port min 5 watt or analogous LED.

Single white navigation Top light 360 degrees viewing min 5 watt or analogous LED.

Two sets of RED lights separate installed to the stern of the boat, minimum 5 watts each or analogous LED, with back-up battery supply to the front of the boat 36 watts minimum or analogous LED. These lights must not be more than 2 metres from the front of the boat or on a special metal arc behind and higher than the pilots head.

Boats racing during day time and night time must have:

Minimum two emergency yellow flashing lights (21 watts or analogous LED) in the front and rear parts of the boat or on a special metal arc behind and higher than the pilot's head.

Power supply of the above mentioned emergency lights carried out over a separate electric circuit or from a separate battery.

For safety the boat must be equipped with an electric main emergency switch, accessible outside of the boat hull. Above mentioned switch should also stop the engine. Separate electric circuit for emergency lights should be operative when cutting the main electric circuit.

Drivers must carry a water-proof torch within the boat.

## 11. SLINGS

Each boat must carry its slings at all times if launch is by crane, whilst on the water and must comply with the safety rules and regulations of rule 205.12 of the UIM Drivers or mechanics must not ride in boats whilst the boat is being craned.

## 12. FIXING EYE

A reinforced cockpit boat must be fitted at the bow with two mooring eyes, one at the top and one at the bottom, eye not less than 25 mm and not further than 250 mm from the front. The fixing shall be strong enough to tow a boat partially submerged. A tow rope must be fixed. It must not be longer than the length of the hull.

## 13. RACE NUMBERS

In the event that two numbers are identical, then the team who enter first can keep their race number. The Scrutineer will issue a further number to the Team and it is the team's responsibility to replace the number. Race numbers must be on the race trailer. An organised will, if possible, notify any team of a clash of numbers prior to scrutineering. Number one is reserved for the winner of the UIM world championship.

Racing numbers must be black on luminescent white.

For races during daylight application rule 206.02. All numbers must be fixed to both sides of the boat on the cell. For V Boats the number must be vertical and behind the drivers head.

## 14. NATIONAL FLAGS

All boats will carry the national flag of all competing drivers.

## 15. UIM PENNANTS

It is mandatory for all boats to carry the UIM Logo to both side of the boat.

## 16. SCRUTINEERING

All boats must be scrutineered before entering the water. It is mandatory for all drivers to be present and the Team Manager. All drivers must be able to prove that they fit within the craft as per UIM rules. The O.O.D. and UIM commissioner will rule upon any such cases that infringe UIM rules on cockpits. Each pilot must have his own helmet and life support vest and this must be produced at scrutineering. All boats must be presented to scrutineers with pickle forks dismantled and boats must have a spare pair that must be presented to the scrutineers.

## 17. REPAIRS

All repairs must be carried out within your designated pit area.

## 18. DURATION

The race will be for a minimum time period of 6 hours and maximum time of 24 hours continuous racing (see Part 34 also).

## 19. THE CIRCUIT

The overall shape of the circuit is not binding but must not be less than 2000 metres, and a maximum of 6100 metres. All circuits must be registered with their N/A and with the UIM according to the rule Water Registration (106.02). The turn buoys will be divided into each class so as not to have boats in different classes turning on the same turn buoy. For Pneumatics: The overall length of circuit must not be less than 1500 metres. The turn buoys for all classes will be the same. The must be at least 500 metres between the main turn buoy.

## 20. TURN BUOYS, AND OTHER BUOYS OF THE RACE COURSE

Turn buoys will be of a single colour either Orange or Red unless there are turns of both left and right then for left hand turns the buoy will be Orange and for right hand turns the buoys will be yellow.

Destroying a turn buoy or other buoys of the race course - the cost of replacement will be charged to the offending team. Maximum cost 250 Euros per buoy + penalties (ARTICLE 38). Each turn will have 2 turn buoys.

## 21. ENTRIES

All entries must be on the organising club's official form and entries must be sent in by the date as requested. Late entries may be accepted providing all paperwork is in order and that their inclusion does not affect the water capacity as homologated. Entry fee for the championship may be charged. Late entries may be fined.

In Endurance Pneumatics Championships the entry of each pilot is registered as follows (№ of class/№ of boat/№ of international license & nationality as per license) - Name of pilot.

For example: 1/07/025HUN - JaanusKuznetzov.

## 22. VALIDITY OF DRIVERS

All drivers must be in possession of a current licence issued by his N/A for the class of boat that he wishes to race. He must also have the N/A permission to race. All other aspects refer to UIM rule 120. A driver must also have a current immersion training certificate if required by the UIM for that class.

## 23. INSURANCE

Any driver who does not carry insurance to meet the requirement of the country in which they are racing, will have to pay, per boat, the required amount to a maximum of 190 Euros.

## 24. TEAMS

For races up to 12 hours there must be a minimum of two pilots and a maximum of 4 pilots, and for races from 12 hours to 24 hours there will be a minimum of 3 pilots and a maximum of 4 pilots and 5 pilots for the Class 1. Teams may practice more than the required number of pilots providing they have all paper work and licences in order. Team managers must notify the Control, 1 hour prior to the race as to their final pilots names and no alteration of the pilots list will be accepted for whatever reason. Failure to do so will lead to D/Q of the team. A pilot must not drive continuously for more than 2 hours, 10 minutes. Any laps over the period will not be included. Minimum rest period for drivers is one hour.

## 25. TEAM MANAGERS

All entries must have a Team Manager who must not be a pilot. In a case where there is more than one boat in a team then the Manager can represent all entries in that team. All penalties and other race documentation at the race site will be forwarded to the Team Manager. The Team Manager must be present at all meetings and scrutineering.

## 26. ADVANCE PROGRAMME

The organisers of the race will forward the advance regulations to all N/A's in English and their own language within 60 days of such race. All aspects of the advance regulations will have at least all those details as listed in UIM rule 202.

## 27. DRIVERS MEETING

It is mandatory for all drivers and Team Managers to attend driver's briefing. It will be in English and the language of the majority of the drivers present and held after scrutineering and at least one hour prior to practice.

## 28. PRACTICE

All new pilots to the course must complete at least 2 laps of practice.

## 29. STARTS

The start will be a flying start behind a pace boat. The signal to start will be via a Green flag.

## 30. FINISHES

The finish of the race will be after the lead boat has completed the time duration. This will be denoted by a chequered flag flown from control and the final positions will be at the time the other boats complete the required time period.

## 31. POSTING OF POSITIONS

Positions will be posted every half hour (first hour ) for the first 2 hours then hourly and every half hour for the last 1 hour.

## 32. CLASSIFICATION

The finish is shown to a driver by waving a black and white chequered flag. All present boats on water will have 10 minutes to cross the line of arrival.

To be classified as a finisher and to gain points you must have completed at least 40% of the class winner's laps and take the chequered flag. Boats not running but complete at least 90% of the class winners distance will be scored after all boats that take the chequered flag.

## 33. POINTS

Points will be awarded in each competing class as follows

1st	20	9th	7
2nd	17	10th	6
3rd	15	11th	5
4th	13	12th	4
5th	11	13th	3
6th	10	14th	2
7th	9	15th and onwards	1
8th	8		



### 34. INTERRUPTED RACE

A race that has to be curtailed for one reason or another and it is impossible for the race to recommence then points will be awarded as follows:

Up to 25% of race time 25% of points,

50% of race time 50% of points,

75% of race time 75% of points,

Over 90% full points.

The responsible boat of final stopping of race does not score points.

If a race is interrupted and can be recommenced within a reasonable period of time then the recommencement procedure will be as the start of the race less completed time. The time period remaining will be the total race time less 15 minutes and less completed time. The distance covered by each part of the race will be added together for the final result. The distance covered, the lap prior to the stoppage will be the laps taken. If the race has to be brought under a reduced speed then the pace boat will take the boats round in order there will be no overtaking. The restart will from the pace boat.

### 35. PRIZES

The UIM will provide Gold, Silver and Bronze medals at the completion of the series of races and the Champions will receive their medals at the last race. The organisers will provide trophies for the first three in each UIM class at each event. Prize giving must be within one hour of the completion of the race or, if protests are being conducted then it will be 30 minutes from completion of protests.

### 36. RESULTS

The results will be forwarded to the UIM offices within 24 hours of the completion of the event.

The general classification will be drawn on additional points of all rounds per pilot(s).

In case of an ex æquo the points obtained in the longest endurance race will determine the winner(s) (there could be various ex æquo positions if it concerns one same team).

In all events, the pilots will be classified and not the boats.

In Endurance Pneumatics Championships the final classification of each pilot is to be done as per 905.33 and 905.21.

### 37. POST INSPECTION

The first three boats in each class will render themselves to the "parc ferme" for inspection immediately after the end of the race. Any boat failing to do so will be D/Q from that race. The only persons allowed in "parc ferme" are OOD, race technical inspectors, the UIM Commissioner, the drivers, the Team Manager and two mechanics. No other personnel are allowed.

### 38. PENALTIES

Any sanction against a driver (Yellow cards or disqualification) will be reported to the UIM. Should a driver be disqualified from that event under any rules of the UIM then the team may continue providing they have the minimum number of drivers. All other penalties will be reported to the Team Manager and displayed at race control.

Penalties are following (up to and including):

Fuel infringement	4 laps
Race infringements	3 laps
Light infringements (after 2 laps of notification)	no laps will be scored.
Craning infringements	4 laps
Failure to attend scrutineering or drivers briefing	5 laps (each absent pilot)
Flag Infringement	3 laps
Priority of boats	5 laps
For missing a turn buoy or other buoys of the race course	1 lap
For hitting a turn buoy or other buoys of the race course	no penalty,
For dislodging or destroying the first turn buoy or other buoys of the race course	3 laps
For dislodging or destroying the second turn buoy or other buoys of the race course	5 laps
Overtaking in the safety corridor before the bridges (in case of low bridges) –	15 laps

Exact definitions for racing and non-racing penalties is to be declared in the advance program as per UIM Circuit Rule 202.

### 39. PROTESTS

The Team Manager on behalf of his driver can make a protest. No collective protests will be accepted. They must be written in English with full details and, if appropriate the UIM rule. The fee for a protest is fixed at 150 Euros, and for a protest against an engine is fixed at 380 Euros. Protest will be heard if possible within one hour of the protest being accepted and the result of any such protest will be given to the Team Manager and driver if possible. If a protest is upheld and laps have been deducted at the next posting of positions the laps will be re-introduced. If a protest comes within the last hour of racing then the protest will be heard as soon as possible and the final result will be not be posted until the protest has been heard. Protest on the final results must be made within half of one hour.

All protests according to rule 905.38 (Penalties) and "driver against another driver" must be handed to the Race Secretariat within one hour after pilots changing.

### 40. YELLOW/RED CARDS

Yellow cards can only be given by the O.O.D. or the UIM commissioner for offences on the water. They must be issued to the Team Manager or the driver on the official UIM form. Other offences are covered within rule 406.06 of the UIM.

### 41. APPEALS

Appeals against any protest not upheld see UIM rule 405.

## 42. BOATS BROKEN DOWN ON COURSE

Any boat that breaks down on the course cannot refuse a tow and must be towed in the direction of the course, unless derogation is granted, if the width of the water level allows this tow in full safety. This must be specified on the advance program. It is forbidden to be towed against the race direction on the race course.

## 43. PRIORITY OF BOATS

Rescue and pace boats have priority at all times. Entering the pit land and refuelling lane must be done at reduced speed and no overtaking unless a boat has become stationary. All boats entering the pits or refuelling area have priority over those departing.

## 44. RESCUE

There must be at least one rescue boat for every 250 metres of course and that the course must be visible at all times from at least two rescue boats. There must be at least one rescue boat every 1000 metres capable of carrying a stretcher or that the boat must be a drop front dory (according to define the circuit).

## 45. PACE BOAT

It is mandatory that a pace boat be launched ready for use throughout the duration of the event and should there be a need for the race to be brought to a much reduced speed, then the pace boat will lead the leading boat flying a yellow flag until such time as the course is clear to race. All boats must remain in the order that they are in with no overtaking permitted. When the race is due to be restarted the yellow flag will be dropped and the green flag raised. When the pace boat marshal is happy that all is in order to restart he will drop the green flag. This is the only signal to recommence racing. The boat refuelling under the pace boat is permitted, except set the briefing. It can leave the refuelling pontoon after the last boat in the race.

## 46. CRANES

In the event of a crane being used for launching there will be a minimum of one crane per 15 boats. If launching is by slipway then one launch vehicle per 15 boats. The slipway must be large enough to allow the number of launch vehicles to work at the same time.

## 47. FLAGS

Red:	Race terminated return to the holding area and await instructions
Yellow:	Danger on circuit,
Yellow:	Pace boat on circuit - no overtaking and reduce speed,
Black:	With race number fixed - driver to return immediately to the pits,

A boat having received a black flag has 3 laps maximum to exit the race course. Any laps done after the initial 3 laps will not be counted.

Chequered black & white:	Race completed,
Green:	Race commenced/recommended.

## 48. PUBLICITY

The organising club and national authority can request that any offences advertising or any that conflicts with the sponsor or sponsors may request it to be covered throughout the duration of the race. All other aspects - see rule 203.051.

## **49. MEDICAL COVER**

The minimum cover for the duration of the race and practice is for two ambulances on station at all times and two doctors, one to be trauma trained. It is advisable to have two stations.

## **50. DRUG TESTING**

All drivers can be subjected to drug and alcohol tests. Any refusal will be deemed as a failure and the drive disqualified. Any tests that prove positive, the drive will be disqualified and reported to the UIM. All other aspects - see rule 205.02.02.

# **950 - DRAG RACES RULES**

## **950.1- DEFINITIONS**

The word "DRAG RACING", defines a particular kind of racing which originated in the United States and is derived from the slang of American mechanics.

First practised in motor racing, drag racing has now been adopted by motorboat racing enthusiasts.

World records of the different UIM series and classes as well as those of the American Power Boat Association, drag records included, can be homologated by the UIM.

The racing regulations of the UIM apply for any point not mentioned in the rules issued annually in the American Power Boat Association Year Book (part. 1 Racing Rules Year Book, volume 1, Racing Rules).

## **960 - FORMULA FUTURE RULES**

### **1. DRIVERS, CLASSES AND TEAMS**

Drivers are race in 6 classes. Classes are determined by the age of the driver on 31 December of the relevant year. Classes are as follows:

Class Dolphin	ages 6 – 7 years
Class 1	ages 8 - 9 years
Class 2	ages 10 - 11 years
Class 3	ages 12 - 13 years
Class 4	ages 14 - 15 years
Class 5	ages 16 - 18 years

Participating in a Formula Future event is at each driver's own risk. As a minor, each participant must have a waiver of liability signed by either parent or other responsible guardian.

Drivers and any possible co-drivers must be able to swim and must wear sports clothes and flat-heeled shoes (with no heels) in order to be allowed to start.

Teams set up by educational institutions, sports clubs and other organisations can take part in the competitions.

Each team includes a maximum of two drivers from each age group. At all events, each national authority may be represented by one team only.

Each team must have an official adult representative, a team manager and must nominate a captain. Each team member must wear clothing to be identified as team member during event and competition according to event timetable.

The responsibility of a captain is to provide management and guidance as well as to ensure the proper behaviour of his young team mates.

All drivers, official representatives of the teams and all race officials must be familiar with the UIM Formula Future rules.

### **2. BOATS, ENGINES AND EQUIPMENT**

Each team includes a maximum of two drivers from each age group. At all events, each national authority may be represented by one team only. Boats, engines, propellers and other equipment required are provided by the organizer and should be of standard commercial production.

Boats must have a maximum length of 3.6m and a width between 1.3m and 1.7m.

When operating the boat, every driver and co-driver shall at all times wear a helmet and a life jacket, provided by the organizer. Any person aboard any boat taking part in races must properly wear a helmet, which complies with the SNELL, FIA, ECE or EN helmet standards, including helmets for white water rafting and bicycle helmets. Organizer is responsible of effectiveness of the helmet provided.

All the boats used at the Championship must have an identification number and/or different colours.

Boats in Classes Dolphin, 1 - 3 shall be RIB type boats powered by an outboard engine with a minimum power of 5h.p. (3.7 kW) and a maximum power of 8h.p. (6kW) for two stroke engines and a maximum power of 10 h.p. (7.4kW) for four-stroke engines, with manual engine steering (tiller arm), if possible with automatic reverse.

A co-driver is mandatory for Classes Dolphin, 1 - 3. The experienced co-driver is to be provided by the organizer for each class and each stage. Within the same class is to be the same co-driver. If the co-driver has to be replaced (for whatever reason), the person replacing him must have the same weight or must carry ballast near to his/her sitting position to achieve the same weight as the replaced co-driver.

The boats for Classes Dolphin, 1 - 3 must be equipped with two separate kill-switches, or alternatively with two separate connections to one kill-switch in order to allow the driver and/or the co-driver to stop the engine immediately.

The driver may start only after the kill-switches of driver and co-driver have been properly attached to their bodies or to any part of their equipment (for example life jacket).

Boats in Classes 4 - 5 shall be RIB type boats, powered by an outboard engine with a minimum power of 10h.p. (7.3 kW) and a maximum power of 15h.p. (11.2kW).

The boats must be equipped with a steering wheel, a jockey seat for the driver with the speed lever on the starboard/right side and a kill-switch.

The driver is allowed to start only after his kill-switch has been properly attached to his body or to any part of his equipment (for example life jacket).

### 3. ORGANIZATION

World and Continental championships in classes 1-5 including UIM Dolphins Cup may be run as separate events at the same venue and date. If there is only one championship per year, it is to be held as World Championship even if there are participating Nations from only one Continent. Continental championships are in parallel slalom only, no manoeuvring.

#### 3.1 - Advance programme

The Advance programme must be in accordance with the UIM circuit rules. In addition, it must mention at least:

- Accommodation of the teams and representatives (prices, distance to the race venue, food, transport);
- Transport possibilities on arrival and departure - from the airport/highway to the venue, maps etc.;
- The boats and engines used for the event with photos;
- Data required for the insurance provided.

#### 3.2 - Accident insurance

The organizer provides a free accident insurance for all drivers.

#### 3.3 - Entries

Entries of the drivers and teams must be received by the organizer at least 4 weeks before the date of the event. Entries must include complete data of all participating drivers of the teams (name, surname, birth date, address, passport number and sex) -they are required for the accident insurance (mentioned in point 3.2).

#### 3.4 - Official language

The official language for all correspondence, documents and meetings will be English - in compliance with UIM rules.

All technical and public announcements should be done both in English and in the language of the host country.

The O.O.D. must speak and understand English or must have an official interpreter with him/her for the duration of the race meeting.

#### 3.5 - Protests

Protests may be submitted only by the team manager.

The Jury meeting will take place directly after the race office receives the protest form with all mandatory documents, or at the first possible time (after finishing the running stage).

Protests concerning any part of the boat, engine or equipment, provided by the organizer, must be submitted not more than 1(one) hour after the finish of the official free practice.

All other protest conditions are in accordance with UIM rule 403.

#### 3.6 - Jury

Jury is set up of from delegates officially nominated by the teams (NA, sports club etc.) - one delegate for each team (with a minimum of 3 persons).

All duties, responsibilities and conditions for the jury are as described in UIM rule 402.

### 3.7 - Registration procedure

Registration procedure must be made as described in the time schedule of the advance programme.

Each driver shall receive a personal number and a registration form.

The personal number shall be in black figures, 20 cm high, on a white square of 25 cm by 25 cm and should be visible at all times during the race.

It is obligatory for the driver to wear his/her personal number during every stage of the race.

When registering, each driver shall be weighed. If the driver has a body weight lower than the statistical average, the organiser will add extra weight (ballast) in order to reach the required average weight (driver +ballast) for each class.

Ballast must be located near the driving position and must be securely attached to the boat.

Statistical average weight:

Class Dolphin	26 kg
Class 1	32 kg
Class 2	40 kg
Class 3	52 kg
Class 4	64 kg
Class 5	71 kg

After the registration procedure is finished, a list of drivers for each team shall be posted. The list must contain:

- Race number;
- Name and surname;
- Sex;
- Date of birth (day/month/year);
- Verified weight and ballast required;
- Class.

For classes Dolphin, 1 - 3 also the name of the co-driver must be indicated

### 3.8 - Team representative meeting

After finishing the registration procedure, a Team Representative Meeting must be held.

Attending the meeting is mandatory for every team representative, coach and jury member.

### 3.9 - Inflatable buoys

Inflatable buoys are to be used, which will have a minimum height of 70 cm (min. 60 cm above the water level), and which will be marked with vertical stripes to easily show any possible rotations caused by touching of the buoys.

All gates must have a width of 2,5 m between buoys.

The following colours are used for the buoys:

- Red for gates and turns;
- Yellow for final gates;
- Blue for the final turn for class 5;
- White for start-finish.

### 3.10 - Flags

The following flags with a size of 80 cm to 80 cm are used:

- Green start (departure);
- Yellow danger on the circuit;
- Red stopping of the race;
- Chequered finish;
- Black-raised by buoy marshalls when competitor collides with buoy or any part of the timing gates. This flag must also be raised if a competitor bumps the jetty or pontoon whilst manoeuvring.

## 4. RACE PROCEDURE

### 4.1 - General

Each race includes 3 stages:

- 1st stage: free practice (point 4.2);
- 2nd stage: manoeuvring (point 4.3);
- 3rd stage: parallel slalom with final races (point 4.4);

Drivers run against the clock.

All the rules will come into force and all penalties can be applied right from the moment of leaving the starting pontoon.

Timekeeping starts after crossing the starting line with the front of the boat (after getting the starting permission with green flag) and ends by crossing the finishing line by front of the boat again.

All drivers must complete every stage according to the drawings and guidelines for the relevant class. There should never be more than one boat on each racecourse at a time.

In classes Dolphin, 1 - 3 the drivers sit or kneel in the boat, the drivers in classes 4 and 5 sit on the jockey seat. It is permitted to hold the sides of the boat to increase stability and safety.

The start must be performed without additional touching of the starting pontoon with the boat.

Getting ashore: after passing the finishing line a boat must land smoothly within the designated area on the pontoon.

#### 4.1.1 Definitions

Getting ashore: after passing the finishing line a boat must land smoothly within the designated area on the pontoon.

Mooring: After passing the finishing line a boat must approach the mooring pontoon and land smoothly within the designated landing area and without bumping. After the boat has come to a complete stop the driver is allowed to put the hands out of the boat to hold tight the boat.

Bumping: A boat is judged to have bumped the pontoon if it hits the pontoon and bounces back more than 300mm (distance as tube diameter) within 1 second.

Length of the landing area: The length of the landing area is identical with the length of the longest boat that is used in the competition.

Drive backwards: The boat is only allowed of driving backwards during moving away from the pontoon.

### 4.2 - Free practice

Free practice is mandatory for every driver.

The manoeuvring racecourse is laid out for the practice on the water.

The driver must practice both circuits, manoeuvring and slalom, according to the race schedule.

The organizer shall determine the timing and duration of the free practice in the race schedule.



The organizer shall ensure that every team will have proportionally the same time for practice, depending on the number of its drivers.

Free practice must be run with the same type of boats and engines which will be used for the 2nd and the 3rd stage and on the same racecourses.

Training order must be determined by drawing lots per country and a team must be informed about this order in advance.

Training is prohibited at the race venue during the week prior to the race. The water area shall be closed until the Friday of the first scheduled training.

#### **4.3 - Manoeuvring**

Manoeuvring consists of:

- Tying knots (point 4.3.1);
- Driving on the manoeuvring racecourse (point 4.3.2).

**4.3.1** Every driver must show his skill in tying the following knots (see addendum):

- Reef knot;
- Bowline;
- Half-hitch;
- Clove-hitch.

The maximum time limit for tying each knot is 60 seconds, beyond which the knot will be considered as improperly done. The driver must raise his arm, after each attempt, when he considers the knot is done.

**4.3.2** Every driver runs the manoeuvring course relevant for his class (see attached drawings).

Each driver is allowed 2 attempts, run consecutively. Both attempts will be performed on the same course, with the same boat and engine - within each class. Only the better attempt will be considered for the results (except of dead-heat situations).

The jury can decide another starting order/system in manoeuvring. If there is a risk of unequal conditions for the drivers caused by significant changes of weather (or similar).

Drivers in classes 4 and 5 must perform a man-over-board manoeuvre.

The boat must approach the mark with its left side during this manoeuvre and must be completely stopped (for example by using reverse gear).

Backwards motion of the boat is not allowed.

After the boat has come to a complete stop the driver raises a lifebuoy (or similar) over his head with both hands and puts it down on the designated mark without throwing it or dropping it down and then continues the course.

Failing to perform a correct man-over-board manoeuvre in the first attempt will lead to a second attempt, but the boat is allowed to move forward only.

#### **4.4 - Parallel slalom**

Parallel slalom is run on the course as shown in the attached drawing.

Two drivers from the same class shall start at the same time, each running on a separate racecourse.

Each driver shall have two attempts - the drivers shall change boats and courses for the second attempt.

Times from both attempts are counted up, adding penalty seconds (if any) and the driver is awarded UIM points for his ranking (point 317.01 ).

The four drivers having the highest score in each class shall participate in the semi-finals and finals.

Pair setting for the semi-finals is according to the personal number of the drivers.

Each semi-final participant shall again have two attempts. The drivers shall change boats and courses for the second attempt.

The semi-final results are determined as mentioned above and the pair setting for the finals is as follows:

- Drivers with 1st and 2nd highest scores in the semi-finals compete for the 1st and 2nd place;
- Drivers with 3rd and 4th highest scores in the semi-finals compete for the 3rd and 4th place.

#### 4.5 - Restarting

Restarting of the engine must be done made by the driver himself - in categories 4 and 5; for lower classes classes Dolphin, 1 - 3 the co-driver's assistance is allowed.

The driver must finish the race after restarting, in order to be allowed to submit a protest to the O.O.D. If the driver is not able to restart the engine himself, he must raise his arms in order to be assisted by the rescue.

The O.O.D. decides if a restart is allowed. If the O.O.D. decides to allow a restart, it must take place immediately.

#### 4.6 - Super Jet Slalom Cup

*Organizer of event can announce in the advance program Super Jet Slalom Cup by the rules of FF Parallel Slalom using Aquabikes Yamaha Super Jet.*

*4 best pilots from maneuvering & 4 best pilots from parallel slalom in each class can take part in Super Jet Slalom Cup. In case of the name same pilot exist in both lists his/her name is to stay in parallel slalom list and his/her name in maneuvering list and to be replaced by the next rider in maneuvering results.*

*The Super Jet Slalom Cup will proceed by direct elimination in two rounds, one on each circuit. The drivers shall change Aquabikes and courses for the second attempt*

*Pair setting for the semi-finals is according to the position in the relevant lists (first with the last, strongest with weakest).*

*In case of equality a third round will determine the winner. The Starting position for the 3rd round will be decided by flipping a coin to choose Aquabike and race course.*

*Final 1/4 8 Pilots*

*Final 1/2 4 Pilots*

*Final 3-4 2 Pilots\**

*Final 1/1 2 Pilots*

*\*The pilots eliminated from the 1/2 Final will dispute the 3rd and 4th place.*

## 5. POINT SYSTEM, RESULTS AND PENALTIES

### 5.1 - Point system

The UIM pointing system to be used is:

1-	400	points	8-	53	points	15-	7	points
2-	300	points	9-	40	points	16-	5	points
3-	225	points	10-	30	points	17-	4	points
4-	169	points	11-	22	points	18-	3	points
5-	127	points	12-	17	points	19-	2	points
6-	95	points	13-	13	points	20-	1	point
7-	71	points	14-	9	points			

Drivers must complete the relevant stage and cross the finishing line in order to be classified for the stage.

The 2nd and the 3rd stage will be regarded as separate championships.

At the end of the 3rd stage, points of the 2nd and the 3rd stage will be added up.

An overall title in the individual competition will be awarded to the three drivers of each class who have the highest scores from the sum of the 2nd and the 3rd stages.

To be eligible for the team competition a National Authority must provide a minimum of five drivers. The final results for the team competition are determined by the points gained in the five best results of the team in the overall individual competitions.

## 5.2 - Results

Results for each class and stage must be posted as soon as possible (and never more than 1 (one) hour after the last driver of that class has finished the relevant stage) in a clearly visible place (as announced in the drivers meeting).

All results must be signed by the O.O.D. and must show the time of posting.

The results of each race must be organized separately in each stage in columns showing clearly:

**5.2.1 Manoeuvring:** knots test penalties, 1st attempt times, 1st att. penalties, 1st att. times including penalties, 2nd attempt times, 2nd penalties, 2nd attempt times including penalties, best times including knots test penalties, ranking, UIM points.

Disqualification shall result in zero (0) points for the attempt.

**5.2.2 Parallel slalom preliminary heat / semi-finals / finals:** 1st attempt times, 1st att. penalties, 1st att. times including penalties, 2nd attempt times, 2nd penalties, 2nd attempt times including penalties, 1st and 2nd attempts combined times including penalties, ranking, UIM points.

If a disqualification occurs in parallel slalom, the driver concerned shall be disqualified from the whole stage because he does not have the required two valid attempts. In the case of disqualification in a semi-final or final, the driver will be ranked last in the relevant heat.

**5.2.3 Individual competition / General:** manoeuvring overall UIM points, parallel slalom overall UIM points, UIM combined points ranking.

**5.2.4 Team competition:** UIM points secured by the top five team members in the overall individual competitions, sum of the top five points, ranking of the team.

**5.2.5 Prize giving:** The three best drivers in Manoeuvring (stage 2), Parallel slalom (stage 3), Individual competition and in Team competition are awarded by prizes. The organizer arranges the prize giving. Class Dolphin winners will be awarded by UIM Dolphin Cup Awards.

### 5.2.6 Dead-heat situations:

**Manoeuvring** - if two or more drivers have the same time in their best attempt (including knots and driving penalties), the driver with the better added attempt time (including penalties for both attempts) will be ranked higher. If one of the drivers has only one valid attempt, he will be ranked lower.

**Parallel slalom** - if two or more drivers have the same added times from their two attempts (including penalties), the driver having the better single attempt time (including penalties) from either his first or second attempt will be ranked higher.

If there is still a dead-heat situation and a decision is required in order to set up the semi-finals or finals, the drivers having the same time must re-run both attempts. After running again only the time of the re-run will be taken into account.

**Individual competition** - if two or more drivers have the same combined number of points from 2nd and 3rd stage, the driver having the best combined times, i.e. the sum of his better manoeuvring attempt (including penalties) and both his parallel slalom attempts (including penalties) - will be ranked higher.

**Team competition** - if two or more teams end up having the same sum of UIM points in the team competition, the sum of points of 1st places are added, if the dead heat situation continues, the same procedure must be followed for the 2nd place until a winner can be defined. This is only possible if both teams have enough drivers to be taken into account.

If any of the above mentioned solutions would not define a winner, there will be a dead-heat result.

### 5.3 - Penalties

For the race courses the following penalties are to be applied:

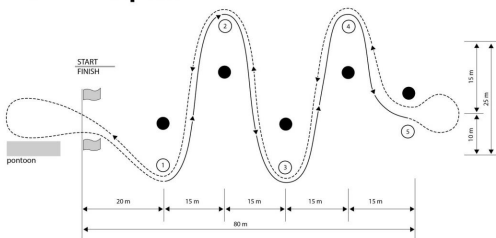
- Additional touch of the starting pontoon	5 seconds
- Bumping the landing pontoon	5 seconds
- Touching of a buoy	5 seconds
- Not passing the gate with the full length of the boat	20 seconds
- 2nd and 3rd attempt each element of the race course (each attempt)	5 seconds
- 4th attempt of the racecourse	disqualified
- Improperly done knot (each)	5 seconds
- Standing during manoeuvring or parallel slalom	disqualified
- Sitting on the side of the inflated boat, or bending	disqualified
- Boat did not stop at the mark during the man-over-board manoeuvre	5 seconds
- Boat did not stop at the landing pontoon when the driver put the hands out of the boat	10 seconds
- Boat goes backwards during the man-over-board manoeuvre	disqualified
- Raising the safety belt with one hand	5 seconds
- Not raising the safety belt not above the head (i.e. lower than drivers head)	5 seconds
- Putting down the safety belt with one hand	5 seconds
- Dropping or throwing the safety belt on the mark	5 seconds
- Second attempt to raise the lifebuoy	5 seconds
- Error doing the circuit (except above mentioned ones)	disqualified
- Driving backwards during moving to the pontoon	5 seconds

Race course for new class Dolphin (manoeuvring):

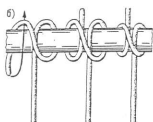
Course scheme of the children's powerboat competitions in manoeuvring  
"Formula Future"



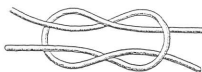
## CLASS "Dolphin"



Departure — start line — along the course, turn around the gate 1, 2, 3, 4 from outside — entrance to the gate 5 — turning behind the gate 5 — again front motion, turn around the gate 4, 3, 2, 1, from outside — finish line — return to pontoon — mooring.



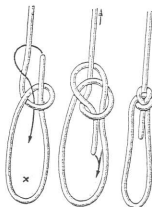
Clove hitch



Reef knot

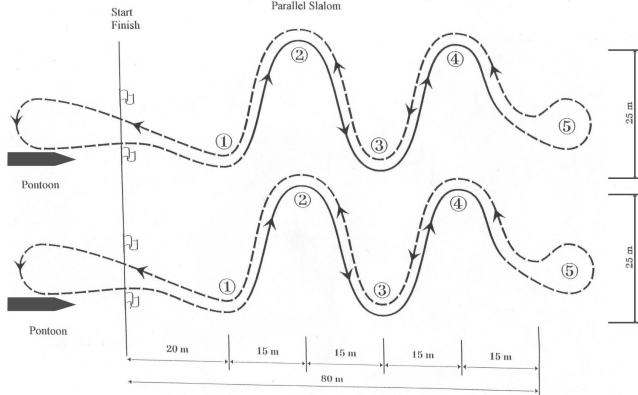


Half hitch



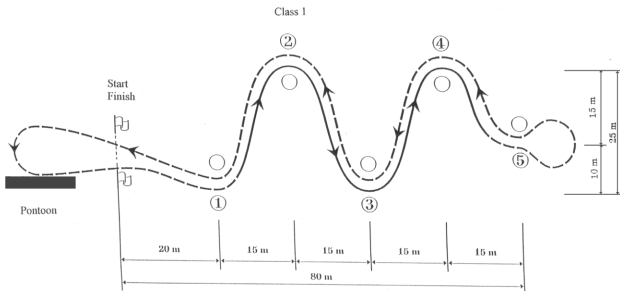
Bowline

Course scheme of the children's powerboat competitions in maneuvering "Formula Future"  
Parallel Slalom



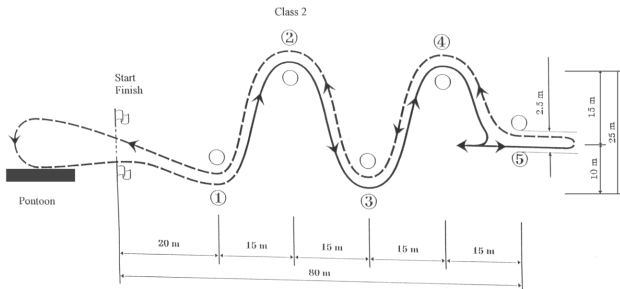
Departure - start line - along the course through the gates 1, 2, 3, 4, 5 - turning behind the gates 5 - again front motion through the gates 5, 4, 3, 2, 1 - finish line - return to pontoon - mooring

Course scheme of the children's powerboat competitions in maneuvering "Formula Future"



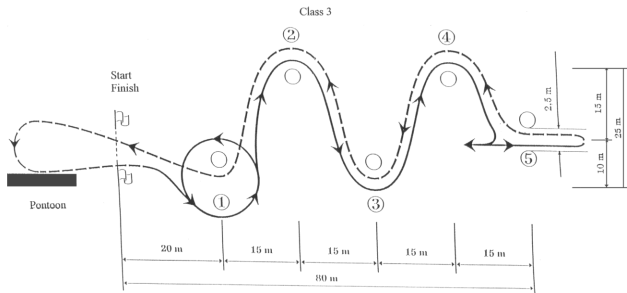
Departure - start line - along the course through the gates 1, 2, 3, 4, 5 - turning behind the gates 5 - again front motion through the gates 5, 4, 3, 2, 1 - finish line - return to pontoon - mooring

Course scheme of the children's powerboat competitions in maneuvering "Formula Future"



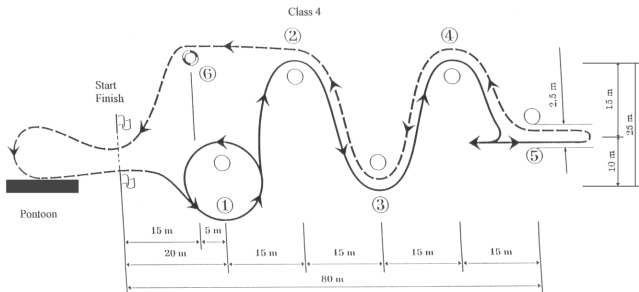
Departure - start line - along the course through the gates 1, 2, 3, 4 - by reversing to the gates 5 - again front motion through the gates 5, 4, 3, 2, 1 - finish line - return to pontoon - mooring

Course scheme of the children's powerboat competitions in maneuvering "Formula Future"



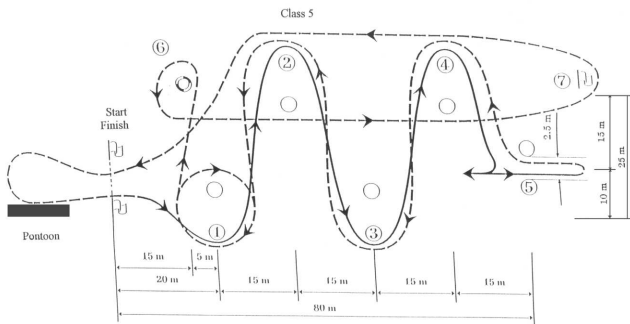
Departure - start line - detour of the gates 5 (the gates 1 are on the left side of the boat) - along the course through the gates 2, 3, 4 - by reversing to the gates 5 - again front motion through the gates 5, 4, 3, 2 - finish line - return to pontoon - mooring

Course scheme of the children's powerboat competitions in maneuvering "Formula Future"



Departure - start line - detour of the gates 5 (the gates 1 are on the left side of the boat) - along the course through the gates 2, 3, 4 - by reversing to the gates 5 - again front motion through the gates 5, 4, 3, 2 - maneuver "man over-board" at buoy 6 - finish line - return to pontoon - mooring

Course scheme of the children's powerboat competitions in maneuvering "Formula Future"



Departure - start line - along the course, turn around the gates 1, 2, 3, 4 from outside - by reversing to the gates 5 - again front motion, turn around the gates 4, 3, 2 from out side - quick detour of the gates 1 (the gates 1 are on the right side of the boat) - maneuver "man over-board" at buoy 6 - speed round: from inside gates 2 and 4, round buoy 7 and from outside gates 4 and 2 - finish line - return to pontoon - mooring



## **970 – SOLAR RACING RULES**

### **1. General**

- 1.1 Solar Racing is governed by these rules and by UIM Circuit rule Groups 100, 200, 300 and 400.
- 1.2 International racing is open to the classes mentioned in Rule 970. Titles shall be given to these classes only. Other local classes can be invited by the National Authorities and or the organizers of Solar Racing, if so, the classes must be indicated in the Advance Program.
- 1.3 An entry fee may be set for all classes including those which may have been given a UIM international Title and must be indicated in the Advance Program.
- 1.4 All participants in the race are expected to have read, understood and agreed to the Regulations. The organization will penalize all participants and teams that ignore or violate the Regulations. Penalties could be given in the form of warnings up to and including disqualification and elimination from further participation.

### **2. General Rules**

- 2.1 In cases where these rules and the rules contained in the Circuit rule Groups are in conflict, these Solar Racing rules will prevail.
- 2.2 Organisers of international races may prescribe deviations from the UIM Group 100, 200, 300 and 400 rules only when they are called for by national legislation or by safety or environmental requirements, or when the organisers deem those rules unsuitable for Solar Racing in general. Such deviations can, however, be applied only if they have been published in the Advance Programme.
- 2.3 An Advance Programme must be sent by the organisers of an international Solar Race to the UIM Secretariat at least 90 days before the race.
- 2.4 All questions concerning the interpretation of the Technical Regulations must be submitted to the organization in writing 15 days before the race. The definitions used, can be found in the Notice of Race.

### **3. Technical condition and safety**

- 3.1 All participants are at all times responsible for the technical condition and safety of their boats during the course of the race,
- 3.2 The design must be made such that the boat can safely participate in the race taking into account all aspects of the race (racing, storage in the paddock, etc.),
- 3.3 Approval of the design and approval during the inspection will under no circumstances exempt the participants of their responsibility.

### **4. Categories**

- 4.1 The race is open to the following boat categories:
  - 4.1.1 A-class boats,
  - 4.1.2 Top-class boats,
  - 4.1.3 V20-class boats,
  - 4.1.4 Young Solar Class boats.
- 4.2 All boats must be single pilot boats.

4.3 The following are the maximum dimensions per class:

Category	A-class	Top-class
Length	8.0 m	8.0 m
Width	2.4 m	2.4 m

- 4.4 The dimensions of the V20-class boats are standard to their particular class,
- 4.5 The dimensions of the Young Solar class boats are standard to their particular class.
- 4.5.1 The boat design as issued by the foundation Young Solar Friesland has to be built according to the description and may not be modified. Installing systems for optimizing the design and other means to increase the speed of the boat are not allowed.
- 4.5.2 The rear part of the boat (transom) must be strengthened sufficiently to carry the load of the engine. The design makes this possible.
- 4.5.3 Components supplied are standard and may not be taken apart or modified. E.g. the original cables attached to the solar panels and the original cables attached to the motor must be used. They may not be removed, shortened or modified in any other way.
- 4.5.4 The propeller may only be replaced by an identical one.
- 4.6 The length is the overall length from the front end of the boat, including the registration panel, up to and including the rear end of the boat, and including the propulsion system. Exceeding the maximum length by more than 0.5% of the allowed length will lead to disqualification.
- 4.7 No maximum draught or height is prescribed for the boats. Participants must however take into account the fact that the depth of the water is limited in certain sections of the routes raced. The actual water depth and height clearance may vary from time to time. It is the responsibility of the participant to check this.

## 5. The Boat

- 5.1 All boats must be fitted with solar panels, which will serve as the sole source of energy.
- 5.2 No prescriptions apply to the use of materials with the exception of the following limitations:
- 5.2.1 The use of (flexible) materials and constructions that might serve as sails is not allowed.
- 5.2.2 The use of materials that may directly, or indirectly, pollute the environment when in contact with water is not allowed.
- 5.3 The use of energy storage systems, other than batteries for storing electrical energy, is allowed (e.g. flywheels, super capacitors, etc.).
- 5.3.1 The total onboard energy storage capacity for A-class boats and Top-class boats is limited to 1.5 kWh (=5.4 MJ). This capacity includes the storage capacity of batteries for storing electrical energy.
- 5.3.2 The total onboard energy storage capacity for V20-class boats is limited to 1.75 kWh (=6.3 MJ). This capacity includes the storage capacity of batteries for storing electrical energy.
- 5.3.3 The total onboard energy storage capacity for Young Solar class boats is limited to the storage capacity of the batteries that are standard to this class.
- 5.4 The pilot must have a clear field of view and have unobstructed hearing at all times.
- 5.5 The boat may not have a closed cabin.
- 5.6 All boats must be designed to ensure that the pilot will be able to evacuate the boat within 5 seconds without any form of outside assistance.
- 5.6.1 This must be demonstrated by means of an evacuation test.

- 5.6.2 The dead man's switch must also be activated simultaneously during the evacuation without having a delaying effect of any nature whatsoever on the evacuation.
- 5.6.3 Hatches that need to be opened before the pilot can evacuate the boat are not allowed
- 5.6.4 The minimum width of the cabin is 50 cm.
- 5.6.5 The cabin must have a suitable seat for the pilot.
- 5.7 The use of safety belts is not allowed.
- 5.8 The cabin may not have any potential hazards for the pilot.
- 5.9 The stability of the boats must be such that a prescribed rolling moment of 150 Nm applied to the boat with the boat loaded with a load equal to the minimum required mass of the pilot, at the location of the seat of the pilot, will not result in lean over exceeding 12.5 degrees averaged over a measurement period of 5 seconds.
- 5.9.1 In that case none of the openings in the hull, such as the outlet opening of the bilge- pump(s) or the edge of the deck or any of the solar panels may be submerged below the waterline.
- 5.9.2 In case (additional) floats are being used, the floats on either side must have an additional volume of at least 50 dm<sup>3</sup>.
- 5.9.3 It is allowed to use more than one (additional) float on either side of the boat.
- 5.9.4 In that case the total displacement of the combined floats on either side must be 50 dm<sup>3</sup> or more.
- 5.9.5 A boat having floats or multiple hulls must be designed such that the highest floater touches the water surface before reaching a roll-angle of 5 degrees.
- 5.10 All boats must be fitted with a commercially available and approved dead man's switch that will remain fully functional at all times while the pilot is on board.
- 5.10.1 This will be tested during the evacuation test,
- 5.10.2 The functionality must be such that when removed the motor stops running and that when replaced it requires at least one more additional action to have the motor start running again.
- 5.11 If the boat is loaded with ballast, it must be properly fixed to the boat.
- 5.11.1 The ballast required to make up for a deficiency in the pilot's mass must be placed in or near their seat.
- 5.11.2 It must be easy accessible for inspection.
- 5.12 It is mandatory for all boats to be fitted with one or more electrical and automatic bilge-pumps.
- 5.12.1 The pump(s) must be designed to empty all compartments that house passengers or electrical components.
- 5.12.2 The pump(s) must be placed such that they can empty the hull both in static and in racing condition. This includes accelerating and decelerating manoeuvres.
- 5.12.3 The system must be designed to ensure that each of the above-mentioned compartments can be pumped empty automatically and independently.
- 5.12.4 The pump(s) must have a minimum combined flow rate of 1500 litres per hour.
- 5.12.5 The pipe(s) and/or hoses that are connected to the pump(s) must have a minimum internal diameter that is not smaller than the pump's outlet.
- 5.12.6 The pipes and/or hoses must be installed such that all bilge water is pumped overboard.
- 5.12.7 If the boat is a multi-hull design, the pump capacity may be distributed; in other words, a catamaran may be fitted with two pumps, one in each hull, and each with a capacity of 750 litres per hour.
- 5.12.8 If floats are fully watertight it is not compulsory to install an electrically driven bilge pump in the floats.
- 5.12.9 If there is a feed-through of any kind in a float, the float will be considered to be not watertight.
- 5.13 All rotating components in or on the boat must be adequately shielded to prevent unintentional contact.

- 5.13.1 This applies both on the water and on land.
- 5.13.2 Propeller(s) used for propulsion are exempted from this rule.
- 5.13.3 In the case of the use of a flywheel for power storage purposes, it must be fitted into a protective housing that is capable of containing all released components in the case of disintegration of the system.
- 5.13.4 The latter characteristic must be demonstrated by means of a suitable test or calculation.
- 5.14 All fastening systems used on board the boat must be mechanically secured.
- 5.14.1 All connections that may rotate during operation must be secured with the use of a cotter pin.
- 5.14.2 The use of securing means, such as "loctite" is not allowed, except with the special permission of the organization.
- 5.14.3 Permission will only be granted based on a prior written application to the organization with due motivation.
- 5.14.4 The application must also include a design description and a description of the need for the use of this type of securing means.
- 5.14.5 In a bolted connection the thread must stick out of the nut with a minimum of two full turns.
- 5.14.6 When using self-locking nuts the thread must stick out of the plastic locking ring with a minimum of two full turns.
- 5.14.7 The use of Velcro is allowed under the condition that this has been clearly indicated in the design and approved by the Organiser prior to the technical inspection.
- 5.14.8 The Organiser may ask additional connections to be installed at all times, especially when it concerns the solar panels or items that influence the safety of the pilot or the operation.
- 5.15 All boats must be designed with a minimum freeboard of 25 cm over the first 2 m measured from the front end of the boat and a freeboard of at least 20 cm over the rest of the boat.
- 5.15.1 Both freeboards must be determined in fully loaded condition.
- 5.15.2 The connection between the hull and the deck must be watertight.
- 5.16 All boats must be designed to be capable of generating sufficient buoyancy under full load.
- 5.16.1 In this context 'sufficient' is defined as the capacity required to carry the complete construction, including the pilot, with a minimum reserve capacity of 100%. In other words: the watertight volume above the waterline has to be equal or larger than the displacement of the hull.
- 5.16.2 The latter capacity must be demonstrated by means of a calculation and a weighing.
- 5.16.3 Young Solar class boats have to install buoyancy aids in the stern as well in the bow, with a combined minimum upward force of 500 N.
- 5.16.4 In addition, the boat must also be designed and built such as to ensure that it remains floating the moment it fills up with water and that there is no contact possible of the water with critical parts of the electrical system like the battery. In this case it may be assumed that the pilot is no longer on board.
- 5.17 All boats must be fitted with a fastening point for a towline in front of the hull (catamarans must have a fastening point on each hull).
- 5.17.1 The fastening point(s) and its supporting structure must be capable of holding a minimum load of at least twice the boat's own weight.
- 5.17.2 The minimum internal diameter of the fastening point(s) must be 20 mm.
- 5.17.3 All boats must be provided with a floating towline with a length of 5 m and a minimum diameter of 8 mm, this line must be easy to cut in case of emergency.
- 5.17.4 Catamarans must be fitted with two floating towlines, with a length of 5 m and a minimum diameter of 8 mm, one attached to each of the two hulls. These lines must be easy to cut in case of emergency.
- 5.17.5 The towline(s) must be carried on the bow of the boat and easily accessible for emergency towing.

- 5.18 All boats must be fitted with a minimum of two types of signaling systems.
- 5.18.1 An uniformly coloured orange or red warning flag with a minimum size of 30 x 30 cm attached to a stick or similar structure with a minimum length of 100 cm.
  - 5.18.2 The warning flag may not be combined with the required boat hook.
  - 5.18.3 An audible warning system, such as a ship's horn audible at reasonable distance, e.g.
    - 5.18.3.1 An orally operated horn
    - 5.18.3.2 A horn operated by a compressed air bottle
    - 5.18.3.3 An electrically operated horn
- 5.19 All boats must be fitted with a clearly visible yellow or orange marker buoy with a diameter of at least 12 cm.
- 5.19.1 The buoy must be permanently connected to the boat by a buoyant rope with a minimum length of 5 m.
  - 5.19.2 The connection and storage of this buoy must be such that when the boat disappears under the water surface the buoy starts floating on the water surface and thereby indicates the position of the boat.
- 5.20 All boats must be fitted with at least one paddle.
- 5.20.1 The paddle must be functional such that it is possible for the pilot to paddle the boat from the normal seating position in the cockpit.
  - 5.20.2 The paddle(s) must have a minimum overall length of 60 cm, a minimum blade length of 30 cm and a minimum blade width of 13 cm.
  - 5.20.3 The paddle(s) must be fastened in an easily-accessible location on board the boat.
  - 5.20.4 The paddle may not be used as a means of propulsion during the race.
  - 5.20.5 The paddle must have a single function. It may not be combined with any other (emergency) device on board the boat.
- 5.21 All boats must be fitted with an approved fire extinguisher with a minimum capacity of 1 kg of extinguishing material suitable for extinguishing fires on board, preferably with a foam based means of extinguishing
- 5.21.1 Only fire extinguishers showing a valid approval are allowed
  - 5.21.2 The fire extinguisher must be mounted in a position such that it can be reached easily by all the pilot from the normal seating position in the cockpit and cannot drop into the water after taking it out of its attachment.
  - 5.21.3 In addition to the manually operated fire extinguisher an automated means of fire extinguishing may be installed.
- 5.22 All boats must be equipped with a boat hook.
- 5.22.1 The minimum length of the boat hook is 1 m.
  - 5.22.2 The boat hook must have a non-metallic hook.
  - 5.22.3 The boat hook may not be combined with the paddle.
- 5.23 In the case of the occurrence of a (technical) failure on board, the participants are entitled to repair and/or replace the failed or flawed components with identical ones.
- 5.23.1 Wherever possible repairs/replacements must be done under the supervision of a Technical Inspector.
  - 5.23.2 In the case of major repairs/replacements, e.g. in the case of the replacement of a battery, the participant will be disqualified for the first upcoming race element.
  - 5.23.3 All repairs to the boats' electrical systems must be reported to the Organiser in advance.
  - 5.23.4 Repairs to other parts of the boats must be reported subsequently.
  - 5.23.5 Replacement or recharging of batteries must be reported to the Organiser and will lead to disqualification for the first upcoming race element.

An equivalent rule applies for non- battery energy storage devices.

- 5.23.6 Modifications to the boat are not allowed anymore after the boat has been technically approved by the Organiser.
- 5.23.7 Modifications demanded by the Organiser however must be incorporated before the given deadline.
- 5.23.8 A change and/or update of the software in any component of the boat is considered a modification.
- 5.23.9 While performing a modification, participation in the race is suspended until the modification has been inspected and approved by the Organiser.
- 524 The average speed of the boats in the A-class and the V20-class must be at least 8 km/h. The average speed of the boats in the Top-class must be at least 12 km/h. This may be tested during a Prologue to the race. During the Prologue a distance of 10 km will have to be covered.
- 525 All sharp edges of the boat must be adequately protected.
- 526 The steering gear of the boat must be sized for adequate controllability, must operate smoothly and must be free of play both in loaded and unloaded condition.
- 527 Adding removable parts to the boat is allowed for A-class boat, Top-class boats and V20-class boats. These additional parts have to meet all necessary requirements of these Technical Regulations
- 5.27.1 The removable parts must either be installed or carried in the boat during the complete race.
- 5.27.2 During the design process it must be clearly indicated that you want to apply this rule and this has to be approved
- 5.27.3 The boat will have to pass the technical inspection both with and without the removable parts installed
- 5.27.4 Marking parts as removable parts after having passed the design process is not allowed
- 5.27.5 Propellers are considered removable parts but do not need to be specifically mentioned
- 5.27.6 Certain parts may not be allowed to be classified as removable parts. These include at least:
- 5.27.6.1 parts necessary for achieving the required stability, for example floats.
- 5.27.6.2 solar panels
- 5.27.7 Physical removal/installation of removable may be done manually. In the case of removal this means taking them off and storing them in the hull of the boat before travelling further. The first bullet of this rule applies. Inside the hull it must be clearly marked where the removed parts will be stored such that they don't go "missing".
- 5.27.8 Using a system that makes it possible to take components (hydrofoils, etc.) in and out of the water without removing them from the boat will have to be a system that is operated electrically from the main battery. This may be done in both a direct (e.g. an electrically operated actuator) and indirect way (e.g. the system requires forward speed of the boat to operate and the required forward speed is achieved via the propulsion system that is powered electrically). Rule 5.28 applies.
- 5.27.9 Trimming the setting of components ( e.g. small adjustments of the pitch angle of the blades of a hydrofoil) whilst being installed and submerged in the water may be done both electrically and manually. Manual operation may be direct (manual operation of a control) or indirect (e.g. using a hydraulic or pneumatic system that is powered manually). The condition for manual operation is that there may be no significant propulsive force being generated from the manual operation of the system.
- 528 The configuration of the boat is not prescribed and may be adjusted throughout the race.
- 5.28.1 Any means to adjust the configuration must be electrically operated from the main battery.
- 5.28.2 It is not allowed to install a secondary power source for that purpose.
- 5.28.3 The adjustment of the solar panels may only be done electrically.

- 5.28.4 Furthermore, the boat must meet all requirements of these regulations in all possible configurations.
- 5.28.5 In Young Solar class boats only the position of the electric motor and the battery may be adjusted. They may be adjusted manually

## 6. Solar panel

- 6.1. Sunlight is the only power source that shall be used for propulsion. Wind and human power are not allowed.
  - 6.1.1. The sunlight may be used directly (received on board during the race using the solar panel) or may be stored in batteries or in other approved energy storage devices.
  - 6.1.2. Batteries may be charged only from the solar panel during the race.
  - 6.1.3. Batteries may be brought to the race fully charged.
- 6.2. The solar panels of the V20-class boats are standard to their particular class.
- 6.3. The solar panels of the Young Solar class boats are standard to their particular class.
- 6.4. The solar panel of A-class boats and Top-class boats must comprise Silicon photovoltaic solar cells.
  - 6.4.1. A-class boats may have a combined exposed solar cell area of 6.00 m<sup>2</sup>.
  - 6.4.2. Top-class boats may have a combined exposed solar cell area of 9.20 m<sup>2</sup>.
  - 6.4.3. The solar panel area will be determined by summing the total area of each solar cell from manufacturer's data sheets. For the purposes of these regulations, the area of an uncut Sunpower cell having a width and length of 125 mm and diameter of 160 mm is 153.33 cm<sup>2</sup>.
  - 6.4.4. Areas of exposed bus bars, junctions and internal structures on top of the solar cell may not be deducted from the solar cell area.
- 6.5. The use of concentrators such as reflectors and/or lenses is not allowed.
- 6.6. The solar panels must be placed horizontally on all boats.
  - 6.6.1. The maximum deviation from the horizontal position is 10 degrees.
  - 6.6.2. This also holds for the maximum deviation from the horizontal position of curved solar panels.
  - 6.6.3. The use of adjustable solar panels is allowed provided they are adjusted by using (electrical) energy derived from the solar panels or the main battery.
- 6.7. Each applied solar panel must be mechanically secured to the boat, either in a frame or otherwise, and suitably protected against the influence of water.
  - 6.7.1. The design of the fastening system must be such that it will be wind- and water resistant in all directions, including, turbulence, waves and gusts.
  - 6.7.2. All parts of the solar panel sticking out of the hull as well as the frames used to attach the solar panels must be provided with protection of sharp edges

## 7. Electronics

- 7.1. Participants are only allowed to use batteries that can be recharged electrically.
  - 7.1.1. The use of other types of batteries, such as mechanically charged batteries is not allowed.
  - 7.1.2. Every team is responsible for its own batteries.
  - 7.1.3. All batteries cells used in the race must be commercially available.
  - 7.1.4. The batteries may under no circumstances be modified in any way whatsoever.
  - 7.1.5. The participants must disclose all data related to the batteries to the Organiser. The battery data provided must at least include a detailed description of the type of battery to be used and the so-called "materials safety data sheet" as supplied by the manufacturer thereby providing the organisation with adequate information in case of an emergency.

- 7.2. The batteries must be mounted in separate housings, such as to eliminate the risk of direct contact between the pilot and the batteries and environmental pollution is prohibited.
- 7.2.1. The purpose of the battery housing is to simplify the mounting of the battery in the boat.
  - 7.2.2. The batteries and the fastening systems must be designed and manufactured such that they will remain fixed in their positions in the case of the boat capsizing and thereby prohibiting environmental pollution.
  - 7.2.3. The battery housing may be a separate housing or may be fully integrated in the hull.
  - 7.2.4. The battery housing must prohibit, in case of damage of the batteries, that electrolyte flows into the hull and/or into the environment.
  - 7.2.5. The battery housing must be manufactured out of materials resistant to the electrolyte of the batteries.
  - 7.2.6. The battery housing may not be made out of a galvanic conductive material.
  - 7.2.7. The battery housing must be made out of a fire resistant material.
  - 7.2.8. The attachment of the battery housing must be designed to withstand a 10 g acceleration or deceleration in any direction.
  - 7.2.9. The use of Velcro for mounting the battery and/or its housing is not permitted.
  - 7.2.10. The minimum distance between the batteries and the pilot is one metre. Young Solar class boats are exempted from this rule.
  - 7.2.11. All requirements with respect to mounting the batteries and their housing also apply to all other means of energy storage.
  - 7.2.12. The housing must be fitted with a forced ventilation system with a minimum capacity of  $0.3 \text{ m}^3/\text{minute}$ . Young Solar Class boats are exempted from this rule.
  - 7.2.13. Alternatively, the battery housing may be closed and cooled in another way (e.g. liquid cooling). In that case the cooling must be adequate for all expected circumstances of weather and power consumption.
  - 7.2.14. In case of a battery failure gasses may never reach the compartment of the pilot.
  - 7.2.15. The ventilation system must be operational at all times from the time the battery is electrically connected to the boat (= when the mains switch of the electrical system is on).
  - 7.2.16. Both the inlet and the outlet of the ventilation system must be located in a position behind the pilot or in an alternative position that is suitably distant from the pilot; all subject to the sole discretion of the Organiser. The minimum distance required is one metre.
  - 7.2.17. The battery ventilation system must be designed such that upward spray and rainwater will not be able to make direct electrical contact with the battery,
  - 7.2.18. The battery ventilation system must be powered by the main battery and/or the solar panels.
- 7.3. The boats may be fitted with a battery pack with a maximum capacity given in rule 5.4 of these regulations. All further references to the battery pack will refer to the 'main battery'.
- 7.3.1. To be able to judge this requirement, all batteries will have to undergo a capacity test.
  - 7.3.2. V20-class boats and Young Solar class boats are exempted from the capacity test.
  - 7.3.3. All batteries tested and sealed in previous races are exempted from the capacity test.
  - 7.3.4. For lithium based batteries this capacity test will be a constant resistance, full discharge test.

The resistance applied during the test is determined by the nominal voltage of the battery and given by the following expression:

$$R_{\text{test}} = V_{\text{nom}}^2 / 1500 (\pm 15\%)$$

Where:  $R_{\text{test}}$  = resistor value used during the test in Ohm  $V_{\text{nom}}$   
 = nominal voltage of the battery in V

- 7.5. Teams using non-lithium based batteries must indicate this during the design procedure. An



appropriate means of testing these batteries will be provided.

- 7.6. The starting point of the capacity test is a fully charged battery.
- 7.6.1. Fully charged is defined as the point where the individual cells have reached their maximum voltage and the battery pack as a whole is balanced.
- 7.6.2. The maximum cell voltages are:
- |                         |                    |
|-------------------------|--------------------|
| Lithium-ion:            | 4.2 V $\pm$ 0.05 V |
| Lithium-Polymer:        | 4.2 V $\pm$ 0.05 V |
| Lithium-Iron-Phosphate: | 3.6 V $\pm$ 0.05 V |
- 7.6.3. A lead-based battery is considered fully charged when the voltage is 14.4 V for a 12 V nominal battery voltage and current through the battery has declined to less than 2% of the nominal capacity of the battery in Amp-hours (e.g. 2 Amps for a 100 Ah battery).
- 7.7. The end of the capacity test is when the battery is fully discharged.
- 7.7.1. Fully discharged is defined as the point where the discharge is stopped by the Battery Management System. This must be the point where all individual cells have reached a voltage below the value given:
- |                         |                   |
|-------------------------|-------------------|
| Lithium-ion:            | 2.7 V $\pm$ 0.3 V |
| Lithium-Polymer:        | 2.7 V $\pm$ 0.3 V |
| Lithium-Iron-Phosphate: | 2.5 V $\pm$ 0.3 V |
- 7.7.2. A lead-based battery with a nominal voltage of 12 V is considered fully discharged when the voltage is 10.5 V. In order not to damage the battery during discharge the discharge will continue until the voltage reaches 11.7 V. At that time a depth of discharge of 70% is considered to have been reached. The full capacity will be calculated on the basis of that.
- 7.8. Only one battery pack per team can be offered for testing.
- 7.8.1. The battery pack offered must be balanced and have been fully cycled for at least 5 times.
- 7.8.2. The organisation does not take responsibility for incorrect functioning Battery Management Systems, unbalanced battery cells, and other kinds of failures of the battery pack that may appear during testing. These will also form no grounds for seeking redress.
- 7.9. A dedicated, properly functioning Battery Management System is mandatory for all batteries other than lead-acid and lead-gel batteries.
- 7.9.1. A solar controller is not allowed as a Battery Management System
- 7.9.2. The system must monitor both the battery's voltage and temperature, and must also be capable of shutting the system down when necessary.
- 7.9.3. For Lithium-based batteries the monitoring of both charge and discharge currents is required. A means of controlling too high currents must be installed.
- 7.9.2. The Battery Management System must be designed to monitor all individual battery cells.
- 7.10. The maximum allowed system voltage is **60** VDC. The maximum allowed system voltage for Young Solar class boats is 30 VDC. However, a set-up of the solar panels where the open circuit voltage is higher is acceptable under the following conditions:
- 7.10.1. When the electrical system is switched on (e.g. a maximum power point tracker or solar controller is active) the maximum voltage in the complete electrical system is **60** VDC or below or 30 VDC for Young Solar class boats.
- 7.10.2. In case the electrical system is switched off, the maximum voltage measured in the system is also **60** VDC, or 30 VDC for Young Solar class boats, with the exception of the part of the electrical system between the solar panels and the maximum power point tracker or solar controller.
- 7.10.3. In that part of the system and under that specific condition the maximum voltage must be 100 VDC or less or 50 VDC or less for Young Solar class boats.

- 7.10.4. The cabling and connectors used as well as the housing of the MPPTs will have to be of insulation class IP65 or higher. Possible cables can be of the type Ölflex solar XLS with Epic solar 4 connectors.
- 7.11. The maximum nominal allowed voltage of the (composed) main battery is 48 VDC.
- 7.11.1. In order to be able to comply with this rule in combination with rule 7.8 also during charging, the amount of batteries placed in series will be limited. The following limitations must be taken into account:

Type of battery	Nominal voltage used	Maximum charge voltage	Maximum allowed number of batteries in series
Lead-acid and lead-gel batteries	12 V	14.4 V	3
Nickel-Cadmium	1.2 V	1.5 V	34
Nickel-metal hydride	1.2 V	1.6 V	32
Standard Lithium-Ion	3.7 V	4.2 V	12
Lithium-Polymer	3.7 V	4.2 V	12
Lithium-Iron-Phosphate	3.4 V	3.6 V	14

- 7.11.2. Young Solar class boats must install 2 12V batteries in series.
- 7.11.3. For the use of other types of batteries not mentioned in the overview the participant is required to contact the organisation to have determined the maximum allowed number of batteries in series.
- 7.12. It is not allowed for a team to install additional batteries at any given time, in any location in the boat and for any purpose with the following exemptions:
- 7.12.1. Hand held navigation and communication equipment powered by batteries is allowed as long as they are not electrically connected to the electrical system of the boat.
- 7.12.2. The use of (laptop) computers powered by batteries is allowed as long as they are not electrically connected to the electrical system of the boat.
- 7.13. All energy conducting parts must be fully insulated such as to prevent the occurrence of hazardous situations in the case of contact and exposure to water (for instructions on how to do this, please refer to the NEN/DIN standards for example). Special care has to be taken in case of boats made out of conducting materials (e.g. aluminium, carbon fibre, etc.).
- 7.14. The design of the electrical wiring and circuitry must be based on standard colour coding (NEN/DIN standards).
- 7.14.1. A plus-cable must be coloured or marked red.
- 7.14.2. A minus-cable must be coloured or marked black or blue.
- 7.14.3. All cables must be provided with a suitable strain relief.
- 7.15. All electrical cables must be properly sized to expected system currents. As a guideline the following table may be used. The table is based on continuous currents in a hot environment. It is the sole discretion of the Organiser to approve the cables used. For this they may divert from the values given in the table.

Crosssectional area (mm <sup>2</sup> )	Allowed current (A)
0.75	6
1	8
1.5	12
2.5	17
4	22
6	29
10	40
16	54
25	71
35	87
50	105
70	135
95	165
120	190
150	220

- 7.16. All boats must be fitted with an emergency mains switch that can simultaneously interrupt the power supply to the engine and the power between the solar panels and the Maximum Powerpoint Trackers / Solar Controllers in emergency situations. Thereby it isolates the power sources from the rest of the electrical system. This switch is not the same switch as the dead man's switch
- 7.16.1. The switch must be capable of breaking the electrical power supply under full load.
  - 7.16.2. The switch must be accessible for emergency personnel from the outside of the cabin. It's position must be marked clearly on the outside of the boat such that the switch can be easily located.
  - 7.16.3. The switch must be clearly marked as an emergency switch.
  - 7.16.4. The switch must be operated via a red coloured 'mushroom' type push button
  - 7.16.5. The 'on' and 'off' positions must be clearly displayed.
  - 7.16.6. The lettering must be of a minimum height of 20 mm.
- I 7.16.7. It is allowed to use one or more relays in the switching system.
- 7.16.8. In the case of the use of a relay or contactor, this relay/contactor must be rated for the application.
  - 7.16.9. A system that short circuits the solar panels will be allowed for interrupting the current to the MPPTs /solar controller.
- 7.17. All electrical systems must be provided with a fuse in serial connection with the main battery ('main fuse').
- 7.17.1. The main fuse may under no circumstances carry more than 200% of the expected power.
  - 7.17.2. The main fuse must be mounted as close as possible to the main battery.
  - 7.17.3. The rating of the main fuse may not be higher than the allowed current in the thinnest wire in the relevant part of the electrical system.

7.17.4. In addition to the main fuse, as a minimum, the following systems must be fused:

- Solar panel
- Motor controller
- Battery
- Battery Management System

- 7.18. Participants are bound to use eye-protecting eye gear at all times when assembling, mounting and / or relocating the batteries and/ or when performing any other types of activities related to the batteries.
- 7.19. It must be possible to easily seal the energy storage system(s) (battery or any other type of energy storage).
- 7.19.1. The participating teams must make sure that the necessary means are made available such that the organisation can apply the seal in a simple and fast way..
- 7.19.2. The Organiser will apply the seal after the boat has been technically approved.
- 7.19.3. If a participant needs to break the seal, he or she is bound to notify the organization as soon as possible.
- 7.19.4. The boat is prohibited from racing from the moment the seal has been broken.
- 7.19.5. The boat may only return to the race once it has been subjected to a technical re- inspection and a new seal has been installed.
- 7.19.6. It must be possible to easily seal the housing. This must be done in such a way that it is not possible to (re)charge the battery with any other source than solar energy and that it is not possible to replace the battery without breaking the seal.
- 7.20. During the technical inspections and/or at any moment on request, the teams are obliged to show the electrical circuitry schemes.

## 8. Appearance of the boats

- 8.1. All participating boats must show the registration number provided by the organisation.
- 8.1.1. The registration number must be positioned on the registration panel mounted to the boat
- 8.1.2. The registration panel must be no less than 300 mm in height by 300 mm in length.
- 8.1.3. The participating team is responsible for the acquiring and mounting the registration panel that must be rigid and permanently fixed to the boat.
- 8.1.4. The registration panel must be positioned above deck no further than 2 meters from the bow.
- 8.1.5. The bottom of the registration panel may not be placed lower than the top of the solar panels.
- 8.1.6. The registration number must be visible at all times and from all angles.
- 8.1.7. The placement of the registration panel may not hinder the accessibility of the towing eye in the prow.
- 8.2. Participants are allowed to finish the boat design with aesthetic embellishments of their own choice taking into account the rules given in the Notice of Race.
- 8.2.1. Participants are also allowed to display their sponsors,
- 8.2.2. These displays may not be in conflict with sound moral standards whatsoever,
- 8.2.3. All subject to the sole discretion of the organization.
- 8.2.4. Young Solar class boats must comply with required striping. This striping has to match exactly. The color scheme used is free of choice. Make sure there are enough contrasting colors to make the striping stand out.
- 8.2.5. The Young Solar class boats must comply with the instructions of the required sticker plan. The stickers provided have to be put on the boat. In this sticker plan, room is provided specifically for 'team sponsors' and 'event sponsors'.
- 8.3. A transponder for tracking and tracing during the race may be provided by the organisation and must be positioned on the boat as instructed by the organisers.

## 9. Inspections

- 9.1. The organization is entitled to conduct inspections of the boats at any time of its own choosing. The participants are bound to cooperate with such inspections.
- 9.2. The Organiser will inspect all boats for full compliance with the requirements prior to the start of the race.
  - 9.2.1. All participants will be notified in advance of the time and location of the inspections,
  - 9.2.2. The organization will invite the participants for an inspection,
  - 9.2.3. During the inspection the participants are required to present their boat in a race-ready condition,
  - 9.2.4. Boats that fail to comply with the applicable requirements will not be allowed to enter the race until the time they do come into full compliance and this has been confirmed by means of a re-inspection,
  - 9.2.5. All modifications or repairs to the boat, made after the inspection, will be subject to re-inspection. In order to judge whether a modification or repair is allowed, refer to rule 5.23.
- 9.3. Participants are at all times responsible for the technical condition and safety of the boat during the course of the race. Approval during the inspections will under no circumstances exempt participants of their due responsibilities.
- 9.4. The inspection set-up will be announced to all participants in advance by means of an inspection form that will be used during the inspection. Participants are asked to prepare themselves for the inspection by means of the inspection form, such that this will facilitate a smooth inspection.
- 9.5. During a race the boats are not allowed to leave the paddock without permission.
  - 9.5.1. Leaving the paddock without prior permission of the Organiser will lead to a disqualification.
  - 9.5.2. No permission will have to be asked when a boat is to be driven to the racing test, the prologue, the sprint or the starting point of an element of a race.

## 10. Racing-test

- 10.1. The participants are required to demonstrate the racing performance of their boats. During this demonstration the participants have to cover a prescribed circuit. The boat and the pilot will be judged on the following aspects:
  - Controllability of the boat,
  - Racing skills of the pilot,
  - Stability,
  - Freeboard in racing condition,
  - Spray characteristics.
- 10.2. In case parts have been classified as removable parts under rule 5.27 the racing test must be passed with and without the removable parts installed.
- 10.3. Based on the results of the racing tests, the Organiser may decide to exclude a participant from one or more elements of the race even if the boat has been found technically in order. This may be a conditional exclusion based on for instance the expected weather conditions.

## 11. Pilot requirements and communication

- 11.1. The minimum age of a pilot at the time of the race is 18 years. Pilots of Young Solar class boats must be at least 16 years of age at the time of the race.
- 11.2. All pilots on board the boat must wear an approved life jacket.
  - 11.2.1. The capacity of the life jacket must be 150 Newton classed or equivalent.
  - 11.2.2. The life jacket may be automatically inflatable when coming into contact with water.
  - 11.2.3. The life jacket must be designed such that it keeps the head of the one wearing it above water (e.g. is supplied with a collar).

- 11.3. All pilots expected to have a minimum mass during the course of the race.
- 11.3.1. To determine the mass all pilots will be weighed.
  - 11.3.2. During weighing pilots must at least wear a bathing suit and an approved life jacket.
  - 11.3.3. The minimum mass for pilots of A-class and Top-class boats is 70 kg,
  - 11.3.4. The minimum mass for pilots of V20-class boats is 80 kg,
  - 11.3.5. The minimum mass for pilots of Young Solar class boats is 60 kg,
  - 11.3.6. In case a pilot weighs less than the required minimum mass, the mass of the ballast that he or she must carry throughout the race will be determined by subtracting the mass of the pilot from the minimum required mass.
  - 11.3.7. The applicable ballast will be marked with a unique mark for the applicable pilot.
- 11.4 All pilots must wear a helmet
- 11.4.1. The helmet must be of a bright orange colour.
  - 11.4.2. An open face helmet is preferred.
- 11.5 All pilots shall be capable of communicating to one member of the on-shore team (radio person) by any appropriate means
- 11.5.1. The means of communication must have a broadcast range of at least 2 nautical Miles.
  - 11.5.2. The means of communication must be integrated into the helmet of the pilot. Pilots in Young Solar class boats may use a hand held means of communication.
  - 11.5.3. The means of communication must be waterproof.
  - 11.5.4. The means of communication must be portable and supplied with a battery of sufficient capacity to last at least one race without being recharged.
  - 11.5.5. A full radio check of each boat will be part of technical scrutineering in order to guarantee that all radios are working.
- 11.6. All pilots should wear bright colour clothes or a bright colour wetsuit. If a pilot wears shoes they may not be buoyant.
- 11.7. If the boat is able to move faster than 20 km/h the pilot must be able to show his or her boat driver permit to the organisation.

## 12. The elements of a race

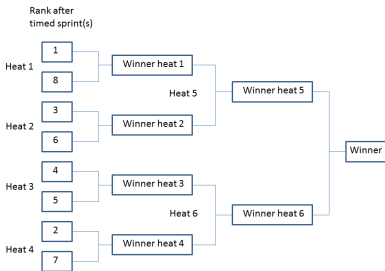
- 12.1. A solar race can be built out of the following elements.
- Sprint Competition
  - Endurance Competition
  - Time Trial
  - Top Speed Competition
  - Stage(s)
  - Match Race
  - Slalom Competition
  - Speed Record Competition
- 12.2. The amount and type of the elements of the race per event will be chosen by the organization and announced on the website of the organization. In case of unforeseen circumstances or in case the weather conditions make it necessary, the organization may add, remove or change the order of the elements of the race.

- 12.3. The Organiser is advised to use video recording to support race control in decision making if needed.

The position of the designated radio person of each team will be defined by the race organizer and will be close to race control. The radio person has to wear his/her boat racing number in a well visible position. The radio person must speak English.

### 13. Sprint Competition

- 13.1. The course of the sprint will be a straight line. The course will be published in the Race Advance Program and/or on the website and/or in the General team briefing.
- 13.2. Boats must cross the starting line in the direction of the finish line.
- 13.3. Boats must cross the finish line from the direction of the starting line.
- 13.4. The sprint competition can consist of the following variants
- 13.4.1. A timed sprint where every competitor races one or more sprints, best time to count.
- 13.4.2. A timed sprint where every competitor races two timed sprints followed by a knock-out competition. The rank after the timed sprints will be determined on the basis of the average time of the two sprints. The eight fastest competitors will move on to the knock-out competition. The timed sprints may be raced in pairs. In the knock-out competition the teams will be paired according to the following scheme:



If there is a tie in the average time of the timed sprints such that more than eight competitors qualify for the knock-out competition then one or more of the heats 1-4 will be raced with three competitors.

- 13.4.3 A round-robin series of sprints. The round-robin competition may be subdivided into several pools. The composition of the pools will be determined by ballot.

### 14. Endurance Competition

- 14.1. The course of the endurance competition will be published in the Race Advance Program and/or on the website of the organisation and/or announced in the General team briefing.
- 14.2. The endurance may start with a mass start ("Le Mans start"). All boats are positioned with the stern towards the quay and the bow facing the course. The boat is held to the quay by a team member. All participants will appoint a runner who will carry a baton. All runners will leave at the same time from the starting point and run towards to their boat. There they hand over their baton to the person holding the boat. Only when this person has received the baton the boat may start racing.
- 14.3. The aim is to complete as many laps as possible within the given amount of time. Depending on the local circumstances the race management may choose one of the two following options for the given amount of time:

Option A: Fixed amount of time – any lap that is completed within the fixed amount of time will be counted.

Option B: Fixed amount of time plus the time needed to complete the lap that has been started within the fixed amount of time – any lap that is completed within given amount of time will be counted.

The option chosen will be published on the website and/or in the General team briefing.

- 14.4 When using option A the finish of the race will be indicated by flying a chequered flag flown from race control at the moment the allocated time has passed. When using option B the finish of the race will be indicated by waving a chequered flag flown from race control at the moment the boat completes the last lap.
- 14.5 If there is a tie in the total amount of laps completed, the tie will be broken by the total time spent when the last lap counted, is completed. The team with the smallest total time wins the tie.

## 15. Time trial

- 15.1. The course of the time trial will be published in the Race Advance Program and/or on the website of the organization and/or announced in the General team briefing.
- 15.2. Boats will start with 1 minute intervals or shorter as deemed appropriate by the Organiser.
- 15.3. The aim of the time trial is to complete the course within the least amount of time.
- 15.4. The finish will be closed for teams that need more than 120% of the time of the fastest boat.
- 15.5. If there is a tie, then each tied competitor will receive points from all places of the tied competitors added and divided by the number of tied competitors.

## 16. Top Speed Competition

- 16.1. The course of the top speed competition will be published in the Race Advance Program and/or on the website of the organisation and/or announced in the General team briefing.
- 16.2. At one point in the course the speed of the boat will be measured.
- 16.3. All teams will be given one or multiple tries to set the maximum speed. The amount of tries will be announced in the General Team Briefing
- 16.4. The highest value measured will count.
- 16.5. If there is a tie in the top speeds between teams, then each tied competitor will receive points from all places of the tied competitors added and divided by the number of tied competitors.

## 17. Stage(s)

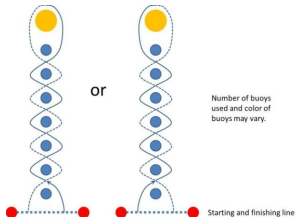
- 17.1. The course of the stage(s) will be published in the Race Advance Program and/or on the website of the organisation and/or announced in the General team briefing.
- 17.2. The winner of a stage will be the team that completes the stage in the fastest time.
- 17.3. Stages may have parts where the race is neutralised. There the timing will be stopped. The timing will continue when the neutralised part has been completed.
- 17.4. In case timing will be stopped and restarted the time to complete a stage will be a calculated time. The calculated time will be the time between start and finish minus the duration of the neutralization(s).
- 17.5. Parts of a stage may be subject to speed limits. Failure to comply with these speed limits may lead to disqualification or time added to the race time.
- 17.6. The finish will be closed for teams that need more than 120% of the time of the fastest boat.
- 17.7. The organisation may decide to impose a time limit for the part before the first neutralisation and/or in between two neutralisations and/or after the last neutralization

## 18. Slalom Competition

- 18.1. One by one, the boats will have to complete a timed slalom.
- 18.2. The start will be a running start.

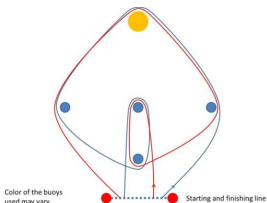


- 18.3. All teams will be given one or multiple tries to set a time. The amount of tries will be announced in the General Team Briefing.
- 18.4. The lowest value measured will count.
- 18.5. The start and the finish will be between two marked points.
- 18.6. Pilots are free to choose to either leave the first buoy of the run to port or to starboard side but must start to alternate (see figure). The number of buoys used will be announced in the General Team Briefing
- 18.7. 3 seconds will be added to the time for every mistake.
- 18.8. After 3 mistakes the run is classed as incomplete and no time will be recorded.
- 18.9. In case of a tie the boat with the least amount of mistakes will be the winner. If a tie remains each tied competitor will receive the same number of points.



## 19. Match Race

- 19.1. In pairs the boats will compete in the prescribed course (see figure). There will be an inner course and an outer course.
- 19.2. The start will be from standstill.
- 19.3. The boat that crosses the finish line first will be the winner of the heat
- 19.4. Cutting across the bow of another boat such that it causes hindrance to the other boat, is not allowed and will lead to automatically losing the heat.
- 19.5. The match race can be executed in the following variants:
- 19.5.1. The winner of the competition will be determined via a knock-out competition. The pairing for the first series of heats will be determined by ballot.
- 19.5.2. The winner of the competition will be determined via a round robin competition. The winner of a heat receives 1 point. The loser of the heat will receive 2 points. If there is a tie at the end of the competition an additional heat between the tied participants will be raced.



## 20. Speed Record Competition

20.1. One by one the boats will run a course with a given length. Depending on the local circumstances the race management may choose one of the following options for the length of the course:

- Option A: 231.5 m (1/8 nautical mile)
- Option B: 402.25 m (1/4 statute mile)
- Option C: 250 m
- Option D: 500 m

The option chosen will be published in the Race Advance Program and/or on the website and/or announced in the General team briefing.

- 20.2. The start will be a running start.
- 20.3. The start and the finish will be between two marked points.
- 20.4. All teams will be given one or multiple tries to set a time. The amount of tries will be announced in the General Team Briefing.
- 20.5. The lowest value measured will count.
- 20.6. The winner of the competition will be the team that sets the lowest time in its class.
- 20.7. Rules for UIM World Speed Records see section 600.

## 21. Scoring

- 21.1. The performance of the team in each of the elements of the race will be converted into a ranking.
- 21.2. The team that has reached the highest rank in that element of the race will be given 1 point. The second best team will be given 2 points, etc..
- 21.3. The points scored per element will be multiplied by a weighing factor per element leading to a total score per element.
- 21.4. All total scores of the elements will be added and will lead to the final total score.
- 21.5. The team that has the lowest final total score wins the race.
- 21.6. Elements of the race counted for overall championship scoring are defined in race Advance Program
- 21.7. The weighing factors to be used are as follows:
 

- Sprint Competition	weighing factor 1
- Endurance Competition	weighing factor 2
- Time Trial	weighing factor 2
- Top Speed Competition	weighing factor 1
- Stage(s)	weighing factor 3 per stage
- Match Race	weighing factor 2
- Slalom Competition	weighing factor 1
- Speed Record Competition	weighing factor 1
- 21.8. If a boat does not start in an element of the race, the points for that element will be the highest in its class of the boats that did start and complete that element plus 10 points.
- 21.9. If a boat does start but does not manage to complete an element of the race, the points for that element will be the highest in its class of the boats that did start and complete that competition plus 2 points.
- 21.10. If at the end of the race a tie remains between two or more boats, they shall be ranked in order of their scores in the last element of the race. Any remaining ties shall be broken by using the tied boats' scores in the next-to-last element of the race and so on until all ties are broken. When one tie has been broken between more than three competitors the remaining competitors ties will be broken by using regulation 21.10 from the beginning.

## **971 – SOLAR SPLASH RULES**

### **1. Purpose of the SOLAR SPLASH**

The SOLAR SPLASH has been established to promote interest in Science and Technology, Education, and Personal Interactive Skills. Established for collegians, it gives students an opportunity to apply theory to a practical project in a team environment. The SOLAR SPLASH itself serves as an opportunity for students to compete and showcase their accomplishments. In order to enhance the students' experiences, the faculty advisor may advise only and may not be directly involved in design or construction. Although it is an intercollegiate competition, high school teams who demonstrate competence may be included.

### **2. Administration**

- 2.1. Application of Rules - The Rules shall apply to the SOLAR SPLASH, hereinafter referred to as the "Event". These Rules become effective immediately and supersede all previous editions.
- 2.2. Right to Revise Rules - The Organizer reserves the right to revise the Rules at any time by providing the participants notification of revisions in the form of Bulletins, revised editions of the Rules, or announcements at the Competition.
- 2.3. Acceptance of Rules - All persons or groups selected to participate in the Event are expected to know and accept the Rules. Participation in the Event shall constitute acceptance of them.
- 2.4. Sponsors - Sponsors are listed at race organizer web-page.
- 2.5. Sanctioning - The Event is sanctioned by the American Power Boat Association (APBA) and UIM as a special event.
- 2.6. Event Officials - The Organizer will select and announce the list of Officials for the Event. These Officials are generally known as "Red Shirts" because of their distinctive red shirts worn at the Event. The Event Officials will be instructed in and responsible for specific duties pertaining to the operation of the Event. The Event Officials shall have the authority and responsibility to ensure compliance with the Rules.
- 2.7. Insurance - Each participating Team is required to provide proof of general liability insurance from their educational institution or written proof that, as a state institution, they are self-insured. Proof of insurance must be supplied with the Technical Report. Failure to do so will result in a 10 point penalty applied to the Technical Report score.
- 2.8. Accidents - All accidents must be reported to an Event Official and the Organizer immediately. Failure to do so may affect a Team's standing in the Event. The Organizer and the Sponsors assume no liability for accidents that occur as the result of poor craft design and construction, unsafe or improper boating procedures, or any form of negligence on the part of the competitors and spectators. Withdrawals - Any team which has agreed to participate shall fulfill such obligation unless excused by the Organizer. Any Team wishing to withdraw must notify the Organizer in writing. If a Team wishes to withdraw at the Event, the Organizer must be notified as soon as possible.

### **3. Definitions**

- 3.1. "Paddock" - The area where participants prepare their craft and store their boat and equipment.
- 3.2. "Staging" - The area between the paddock area and the "On Deck" area.
- 3.3. "On Deck" - The area between the staging area and the Launching Site. Boats in this area must be prepared for launch inspection.
- 3.4. "Launching Site" - The area which extends 10 meters back from the shoreline and extends outward from the shoreline 15 meters.
- 3.5. "Restricted Area" - The four areas above will be enclosed by a fence and movement in and out of this area will be through a monitored gate. Entry is permitted only after an APBA waiver is signed.

- 3.6. "System Voltage" - The voltage measured with a VOA meter between the system ground and any point in the electrical system.
- 3.7. "Source Voltage" - The nominal value, e.g. 24 VDC or 36 VDC, output voltage of the battery pack.
- 3.8. "Dead-man's Switch" - Any device that cuts off power to the motor if the skipper leaves the craft.
- 3.9. "Attempt" - Once the Starter says "GO" the event is considered to be started.

#### 4. Registration

- 4.1. Registration - The Organizer will require all persons participating or officiating at the Event to Register on Wednesday starting at 8 am. Registrants will be divided into the following categories:
  - A. Participants (Skippers and Crew)
  - B. Officials
  - C. Volunteers
  - D. Sponsors and VIPs
- 4.2. Badging - All Registrants will be badged by category when they register to make them easily identifiable at the Event. Badges will be issued after all necessary waivers have been signed, signifying eligibility to participate in the Event. Badges must be worn at all times during the Event, except by the swimmers (8.2).
- 4.3. Point of Contact - One person, preferably the Faculty Advisor, must be designated as the primary point of contact for the team during the Event.
- 4.4. Faculty and Guests - The number of faculty at the Event is not limited. Alumni, family, and friends are all welcome, but may not be team members for insurance purposes.
- 4.5. Ballast - The official skipper weight for the competitive events shall be seventy (70) kg. Each skipper will be weighed when he or she registers. Skippers will be weighed in their bathing suits. If a skipper's weight is less than 70 kg., ballast will be added to make up the difference. If the weight of the skipper is over 70 kg., no credit will be given. Skipper and ballast will be identified with unique tags. The ballast corresponding to the skipper must be carried in the boat when it is on the water.
- 4.6. Release of Liability and Image Release - Everyone involved with the Event – Participants, Faculty Advisors, Officials and official visitors – are required to sign this release upon arriving on-site. The Release is available at Registration.
- 4.7. Waiver for Skippers - All participants that will be on the water in a boat must be APBA members. Registration can be done at [www.apba.com](http://www.apba.com) prior to the event (bring your APBA membership number with you) or can be done at the Event. The cost is \$25.
- 4.8. Waiver for Minors - Anyone under the age of 18 is required to have this waiver signed and notarized by a parent or guardian in advance of the Event.

#### 5. Entries

- 5.1. Entry Date - Any 2-year or 4-year college, university, vocational school, or high school is eligible to compete. Any team entering a boat must submit an entry form by the date defined in Event Advance Program.
- 5.2. Team Member Eligibility - Anyone who has attended the participating educational institution as a full time student in one of the past two semesters or two of the past four quarters, or part-time for the past year, is eligible to serve as a team member.
- 5.3. Skipper Eligibility – The skipper must be a team member and at least 14 years old.

- 5.4. Entry Forms and Fees are defined in the Event Advance Program and must be submitted for each craft. Each participating institution will be limited to two entries. Each entry must be in the name of the School and signed by a Dean or Principal.

Entries by a club or individuals not formally affiliated with the school will not be accepted. Entries must be sent to address defined in Event Advance Program.

## 6. Venue

- 6.1. Site pictures and address are added to the Event Advance Program.
- 6.2. Qualifying - The course will be laid out as described in section 9, Competition Events.
- 6.3. Solar Slalom - The course will be laid out as described in section 9, Competition Events.
- 6.4. Sprint Course - The course will be laid out to be logistically convenient. The course will be 300 meters in length.
- 6.5. Endurance Course - The course will be a closed loop, not exceeding 2 km in length, and is likely to be irregular in shape due to the shoreline and spectator areas.

## 7. Regulations

- 7.1. Classes - only in the Open Class.

The "Open" Class competition events will include:

\* Solar Slalom \* Sprint \* Solar Endurance

- 7.1.1. Solar Slalom - All craft will be considered "electric" for the Slalom, i.e. the solar energy conversion device(s) may be removed.

7.1.2 Solar Endurance - All craft will be powered by direct and stored solar energy. A minimum of 100 Watts of solar power under one sun conditions must be carried on the craft. Only one set of batteries may be used for one Endurance Heat. Batteries cannot be changed during the heat.

- 7.1.3. Sprint - All craft will be considered "electric" for the Sprint, i.e. the solar energy conversion device(s) may be removed.

- 7.2. Technical Specifications

7.2.1. Length - The overall length of the craft may not exceed 6 meters (19 ft, 8 in). This does not include the boat number sign.

7.2.2. Width - The maximum allowable width, including the solar array, is 2.4 meters (7 ft, 10.5 in).

7.2.3. Height - The maximum allowable height above the waterline is 1.5 meters (4 ft, 11 in). This height can never be exceeded during the events. This does not include the boat number sign.

7.2.4. Depth - No restriction. An excessive depth may make the craft awkward to handle near shore and may increase the likelihood of encountering underwater obstacles.

7.2.5. Cross Sectional Area - In profile, the fixed area (such as the hull) is unrestricted. The solar array may be fixed or may be in the form of one or more movable panels.

- 7.3. Materials - Teams are encouraged to be creative in the selection of materials. The only restrictions are 1) flexible materials are not allowed to create a sail, 2) any materials that would pollute the water are not allowed.

- 7.4. Power - Sunlight is the only power source that shall be used for propulsion. Wind and human power are not allowed. The sunlight may be direct (received onboard during the Event using energy conversion devices) or may be stored in batteries or in other approved energy storage devices. Batteries can be charged only from the inspected energy conversion devices during the Event. Batteries may be brought to the Event fully charged.

- 7.4.1. Batteries - Craft are allowed to carry 45.5 kg (100 lb) of lead-acid batteries in all events. A

maximum of two sets of batteries will be inspected and permitted for use in the competition.

- 7.4.2. Storage of Solar Radiation - All crafts in the Event will be allowed to store solar energy in their batteries at any time during daylight hours from the time of registration to the completion of the last competition.
- 7.4.3. Supplemental Batteries - The bilge pump and skipper's radio must be powered by supplemental batteries. Measurement and telemetry devices may also be powered by supplemental batteries. Any other devices requiring electric power must use the energy storage as defined in Rule 7.4. The batteries are not limited to lead-acid technology, and the bilge pump battery must be securely fastened to the hull. Supplemental batteries may be charged from sources other than the inspected energy conversion devices.
- 7.4.4. "System Voltage" - May not exceed 52 VDC or AC RMS.
- 7.4.5. "Source Voltage" - May not exceed 36 VDC nominal value (usually 3 batteries). A maximum open circuit voltage of 52 VDC for the photovoltaic charging devices is allowed.
- 7.4.6. Energy Storage Devices - In addition to the storage of solar energy in batteries (7.4.1), energy may be stored using other devices such as capacitors or flywheels. Storage of energy may begin at the "on deck" time (3.3).
- 7.5. Visibility - The skipper must have unobstructed vision forward and at least 100° to either side.
- 7.6. Stability - The stability of the craft will be tested by placing 10 kg at the sheer line (outer edge at the beam) with the skipper stationary in the normal operating position. Craft must not heel more than 15°. Skipper must remain centered with hands/feet in normal position.
- 7.7. Dead-man's Switch - It must be functional at all times when the skipper is in the boat and must be demonstrated in an egress test during Technical Inspection.
- 7.8. Circulation - Fresh air must be provided for the skipper if the cockpit is enclosed.
- 7.9. Ballast - The ballast must be placed in a manner such that the ballast will fall out of the craft if it capsizes (turns over 180°) or adequate flotation must be provided for the ballast.
- 7.10. Electrical
- 7.10.1. Shock Hazards - All exposed conductors operating at greater than thirty-six (36) volts must be properly insulated.
- 7.10.2. Battery Type - Only secondary (electrically rechargeable) batteries are permitted. Fuel cells, primary batteries, or mechanically rechargeable batteries will not be approved. Each team is responsible for supplying their own batteries. The batteries must be commercially available, lead-acid, unmodified with their weight consistent with the Rules. Batteries must be absolutely stock (as manufactured) in every sense. The battery modules may not be modified in any manner, including the addition of electrolyte additives, case modification; or plate addition, removal, or modification. Manufacturer's specifications, plus MSDS sheets, must be supplied with the Technical Report. Failure to do so for the batteries you plan to use will result in a 10 point penalty applied to the Technical Report score.
- If you do not supply literature in the Report, you will be penalized, your batteries will be weighed on site, and no tolerance beyond the prescribed weight will be allowed. If you decide to use batteries different from those in your Technical Report, you may do so with no penalty by bringing the new batteries and Manufacturer's specifications, plus MSDS sheets, to Inspection on site.
- 7.10.3. Battery Safety - Batteries must be enclosed in one or more battery boxes or a portion of the hull to separate them from the skipper. Battery containment shall not be sealed and must allow for ventilation. Battery containment must protect the skipper from battery explosion and leakage, and may be plastic, fiberglass, or similar materials that will not chemically react rapidly to battery acid. All electrical cables must be properly sized to expected system currents.
- 7.10.4. Motor Switch - All craft must have a switch wired to disconnect all power to the motor. The device must be able to interrupt full load current. It must be clearly marked in 10 mm high letters as the "Motor Switch" and be plainly marked with "ON" and "OFF" positions in 10 mm high letters. A relay may be used for the switch function.

- 7.105. Main Fuse - A separate fuse (not a circuit breaker) must be in series with the main battery and the rating must be such that it protects the craft's wiring.
- 7.11. Radios – During all events radio communication between the skipper and a team member on shore is required. There is no restriction on the type or frequency of voice or telemetry radio communication. Radios will be checked during technical inspection, and channels will be assigned. A team member must be in the designated area with a radio any time their boat is on the water.
- 7.12. Skipper Cockpit - The skipper's cockpit must provide for the skipper's unassisted exit within 5 seconds in case of emergency. The five (5) second exit, as well as the function of the dead-man's switch, will be checked during Technical Inspections.
- 7.12.1. Harnesses - No harnesses or restraints to hold the skipper in place will be allowed.
- 7.12.2. Safety - The cockpit area will be inspected for hazards and compliance with the Rules during the Technical Inspections and in the Staging and/or On Deck areas.
- 7.13. Fasteners
- 7.13.1. Steering System - All fasteners associated with the craft's steering system must be equipped with locking nuts, double nuts, or nuts secured with safety wire or cotter pins. Loctite® may be used in areas of difficult accessibility.
- 7.13.2. Batteries - Batteries must be secured to the hull. This must be done with a strap not less than 1¼" in width, or other hold-down device, that will not allow the battery to come loose if the boat capsizes. Velcro is not acceptable.
- 7.13.3. Solar Panels - Each panel, with or without a frame, must be attached with a mechanical fastening to the hull. The design should take into account the possibility of gusty winds during the events. In addition, a lanyard must be attached from each solar panel to a secure member of the hull or a frame that attaches to the hull. The lanyard must be strong enough that it will not break if the panel should go into the water while the boat is moving.
- 7.14. Safety Equipment
- 7.14.1. Life Preservers - A life preserver, USCG approved Type I, II, or III, must be worn by all craft occupants and safety craft occupants at all times.
- 7.14.2. Buoyancy of Craft - Sufficient flotation must be provided on board so that the craft cannot sink, even when filled with water. A 20% safety factor must be included in the calculations. Verification calculations must be included in the Technical Report. Failure to do so will result in a 5-point penalty. Revised calculations must be presented at Inspection if significant changes have been made since submission of the Technical Report.
- 7.14.3. Towing - A fitting for emergency towing must be attached at the bow. Its hole diameter must be at least 14 mm (0.56 in). All boats must carry a minimum of 5 meters of towing line, which will be provided at Registration. The towing line must be attached to the fitting and must be made easily accessible for emergency towing.
- 7.14.4. Signal Devices - Two signal devices must be carried on board the craft at all times. They are:
- A. Audible - a sound-producing device (a pressurized air can is acceptable).
- B. Visual - an orange ("skier in the water") warning flag. This flag must be displayed in the event of a breakdown. A socket for the flag must be provided to allow the skipper to paddle the craft.
- 7.14.5. Paddle - A paddle, no less than 60 cm (23.6 in) long with a blade at least 13 cm (5.1 in) wide, must be on board at all times. The skipper will be required to propel the craft with the paddle during Technical Inspections.
- 7.14.6. Fire Extinguisher - A U.S. Coast Guard approved fire extinguisher with a minimum capacity of one pound must be carried on board.
- 7.14.7. Automatic Bilge Pump - an automatic electric bilge pump that is powered by a supplemental battery is required. The pump must have a minimum rating of 360 GPH, such as a model #24-35 pump made by Rule or equivalent. The discharge hose may not be smaller than the outlet on the pump. The hose must be secured to the hull to ensure that the discharge goes overboard.
- 7.14.8. Covers and Shields - The craft's revolving parts must be suitably covered to prevent accidental contact. All steering linkage must be shielded from contact with the skipper. If a flywheel is used,

an NHRA approved scatter shield must cover it.

- 7.15. Propeller Safety - The motor may not be run with the propeller attached when the boat is on land. If a boat is taken out of the restricted area, the propeller must be removed from the shaft.
- 7.16. Boat Impound - Once a boat is brought to the competition site, it must remain on site throughout the competition.

## 8. Inspections

All craft will be inspected to verify compliance with the Rules. Any Team not passing Technical Inspections will be required to correct the deficiency prior to Qualifying. Craft may be weighed during Technical Inspections. Each team will have a copy of its Technical Report available at Inspection time. Any changes made after Inspection require reinspection.

- 8.1. Safety - Each team is responsible for the seaworthiness of their craft. Passing Technical Inspections does not relieve the Team of any liability. All craft must be maintained in a safe, seaworthy condition at all times.
- 8.2. Swimming Ability - Technical Inspections will include a brief test (50m or less and treading water for 1 minute) of the swimming ability of all team members who may skipper the craft. Participants will not be allowed to use any flotation equipment or any propulsion device such as "flippers" to assist them.
- 8.3. Configuration – All entries (referred to as boats or craft) must conform to the following definitions. The boat will have a skipper who will be the sole occupant.

The only two components that may be removed from or added to the boat for different configurations are the solar panels and the batteries. However, the boat configuration may be modified by replacing or exchanging other individual components (motors, propellers, drive train components, rudders, etc). All components (other than solar panels and batteries) that will be used in any of the configurations must be safely secured within the boat for all configurations and all competitions.

In the Endurance configuration, solar panels must be in place. This configuration will be used during part of the Qualifying Event (the Maneuverability course) and in the Endurance Event. No changes to the configuration are permitted between Qualifying and the Endurance Event.

The Sprint configuration will be used during part of the Qualifying Event (the 70m Sprint course) and in the Sprint Event. Solar panels are optional. No changes to the configuration are permitted between Qualifying and the Sprint Event.

For the Solar Slalom, either configuration may be modified. Solar panels are optional. Replacement or exchange of other parts (motors, propellers, drive train components, rudders, etc) is allowed, but is limited to onboard components as previously described.

All components used in any configuration must be inspected along with the craft. All craft will have their configuration verified in the staging area before competing. The Technical Manager may perform inspections at any time at his discretion.

- 8.4. Solar Array Output - All participants must have their solar collection devices checked to verify that the output does not exceed 480 Watts under normal one sun conditions. Commercially-built solar panels will be verified for compliance by using the manufacturer's specifications. Student-built solar panels will be verified for compliance by using the individual cell specifications, which must be provided at Inspection. A power allowance of 10% will be given to student-built panels, i.e. the total power of the individual cells can add up to 528 Watts.

## 9. Competition Events

- 9.1. Morning Meetings - An open meeting will be held each morning, at 8 a.m., unless otherwise posted, before the day's events. Attendance by a skipper and the Team Leader is mandatory. Failure to do so will result in a penalty and team representative(s) must be briefed and sign a waiver.



9.2. Start and Finish - All on-the-water events will commence from a standing start. Each Event's finish is indicated by the bow crossing the appropriate mark.

9.3. Course - Courses for the on-the-water events are defined below (courses may be as shown or mirror-image). Boats are required to get to the start line and return to the Launching Site by motoring or paddling unless towing is required for safety.

9.3.1. Qualifying - The primary purpose of Qualifying is to determine the eligibility of Teams to participate in the Event. Qualifying will be used to test the safety, seaworthiness, handling, maneuverability, and "qualifying time" of each craft. The track of the boat through the Maneuverability course must generally conform to the diagram and may not vary by more than 15 meters from the prescribed path.

9.3.2. Solar Slalom - The course will follow the Maneuverability course in the manner shown.

A 70-meter straight line Sprint course will be set up and timed to demonstrate the ability of the skipper to control the boat from a standing start in a straight line under full power. Qualifying Time will be calculated from the times on the Maneuverability and Sprint courses and will be used in determining points towards the overall winner.

9.3.2. Solar Slalom - The course will follow the Maneuverability course in the manner shown.

9.3.3. Sprints - Sprints will be held over a 300-meter straight course.

9.3.4. Endurance - The event will be held over a closed course not exceeding 2 km in length. There will be two, 2-hour heats, one in the morning and one in the afternoon. All entries must carry their solar energy conversion device(s), as inspected, on board during the Event. Any changes in the solar energy conversion devices must be reinspected and reapproved before competing.

9.4. Overtaking - Once an overtaking craft establishes overlap (the bow breaks an imaginary perpendicular plane across the stern of the overtaken craft), the overtaking craft has the right-of-way.

9.5. Buoys - The first craft to reach a buoy has the right-of-way until the stern of the craft has cleared the buoy. If a craft strikes a buoy, a penalty will be assessed (see Rule 12).

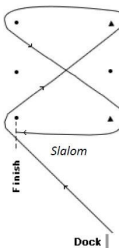
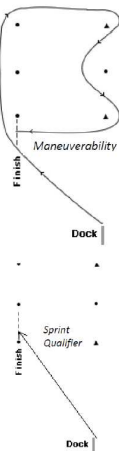
9.6. Leaving the Course - In the Solar Slalom and Endurance Events, if a boat leaves the course for any reason, it must re-enter at the same point or further back.

9.7. Support Craft - No support craft will be allowed.

9.8. Scoring and Results - The results of each day's events will be available no later than the following day's Morning Meeting. The results of the final day's events will be announced and posted at the final awards ceremony.

9.9. Overall Scoring - In order to determine an overall World Champion, the following overall scoring system is used:

Technical Report - 90 points. The report judged as the best will receive 90 points. Others will receive fewer points as judged by a panel of technical reviewers. See Rule 9.11 for Technical Report format and criteria.



Visual Presentation - 40 points. The presentation should be targeted to both a general audience and the judges. The topic of the Visual Display should directly relate to significant and/or new features of the team's boat. Points awarded will be based on overall visual appeal, clarity of message, and ease of understanding. The display should be resistant to wind and water and must be set up from 9 a.m. to 5 p.m. Thursday and Friday; and from 9 a.m. Saturday until 1 p.m. A five (5) point penalty may be assessed for failure to display during the required hours.

Qualifying - 100 points. Your Time will be the sum of your Maneuverability time plus five times your Sprint Qualifying time. The fastest qualifier will receive 100 points. All other qualifiers will be scored by the formula:

$$\text{Your points} = \frac{\text{Winner's Time}}{\text{Your Time}} \times 100$$

If multiple attempts must be made in order to qualify, your qualifying time on that course will be multiplied by the number of attempts. Failure to complete the Maneuverability course prevents an entry from competing in the Endurance Event. Your Time will then be twenty times your Sprint Qualifying time multiplied by the number of Sprint Qualifying attempts. Failure to complete the Sprint Qualifying course prevents an entry from competing in the Sprint Event. Your Time will then be four times your Maneuverability time multiplied by the number of Maneuverability attempts.

Workmanship - 20 points. Points awarded will be based on quality of workmanship as determined by a panel of judges.

Solar Slalom - 100 points. The same scoring formula that is used for Qualifying will apply. If a competitor fails their first attempt, additional attempts may be allowed, time permitting. If multiple attempts are made, Your Time will be multiplied by the number of attempts. If a competitor does not complete the Solar Slalom, they will receive no points for the event.

Sprint - 250 points. Your Time will be the sum of your two best Sprint times. If a competitor completes just one Sprint heat, Your Time will be four times the time of the completed heat. If a competitor completes no heats, they will receive zero points in the Sprint.

$$\text{Your points} = \frac{\text{Winner's Time}}{\text{Your Time}} \times 250$$

Endurance Event - 400 points. The purpose is to go as far as possible in two 2-hour heats. Total distance traveled will be recorded to the nearest 0.25 lap completed.

$$\text{Your points} = \frac{\text{Winner's Time (2 heats)}}{\text{Your Time (2 heats)}} \times 400$$

- 9.10. Seeding – First round Sprints consist of two-boat heats, which will be filled in the order that Qualifying is completed. Second round Sprints consist of three-boat heats, which will include a fast, medium, and slower boat based on first round results. The three boats with the fastest times in the first two rounds advance to the Championship Heat. Prior to the Championship Heat, all other boats also run a third time, grouped from slowest to fastest. All boats start at the same time in the morning and afternoon Endurance heats.
- 9.11. Technical Report - A technical report is required. A PDF copy must be received by Headquarters by date defined in Event Advance Program. The boat number must be displayed on the cover in a minimum 36 pt. type. The names of all students and faculty advisors involved with the project must appear on the cover. Reports will be made available for participants of future Events. Requirements for the technical report are detailed on [www.solarsplash.com](http://www.solarsplash.com).

## 10. Graphics

- 10.1. Boat Number Signs - Each craft will have a "boat number" assigned by the Organizer. Each team will be provided with a base and an "L" bracket for their "boat number" sign. The base, or a satisfactory substitute, must be mounted in a manner that will allow for nonrotating display of the sign. All participants will be provided physically similar signs. These signs may not be modified. The sign will not be included in the dimensions of the craft.
- 10.2. Event Logo - The Event identification and logo (part of the boat number sign) must be displayed at all times the craft is on the water.
- 10.3. School Name - School names on the craft are optional.
- 10.4. Inappropriate Graphics - The Organizer reserves the right to disapprove any graphics it deems inappropriate or offensive. The decisions of the Organizer are final. No graphics will be added to the craft after Technical Inspection without the Organizer's approval.

## 11. Dates and Times

- 11.1. Competition Activities - Begin at 8 a.m. and end at 5 p.m. daily.
- 11.2. Paddock Closure - The paddock area will be closed daily from 9 p.m. to 7 a.m. On-site overnight security will be provided.
- 11.3. Registration - Begins on Tuesday at 8 a.m. All boats must be registered by Wednesday at 9 a.m.
- 11.4. Morning Meetings - Held at 8 a.m. Wednesday through Saturday.
- 11.5. Technical Inspections - Mechanical and electrical inspections must be completed by Wednesday at noon.
- 11.6. Swim Test - Held on Tuesday afternoon, time to be announced.
- 11.7. Qualifying - Begins Wednesday at 8:30 a.m. Must be completed by Thursday at noon.
- 11.8. Solar Slalom - To coincide with Qualifying.
- 11.9. Endurance - Scheduled for Friday from 10 a.m.-noon and 2-4 p.m.
- 11.10. Sprint - Round 1 of the Sprint heats is scheduled for Thursday afternoon, Round 2 is scheduled for Saturday morning, and Round 3 for Saturday afternoon.
- 11.11. Weather - The Sprint and Endurance competition days and times are at the discretion of the Organizer. Weather conditions may dictate competition days and times.

## 12. Penalties

Any Team failing to comply with the Rules, as stated herein, may be penalized. Officials are required to record all instances of unsafe conduct, and penalties will be assessed as follows:

- 12.1. Qualifying
  - 12.1.1. Leaving the Course - If a craft leaves the Qualifying course, as defined in Rule 9.3.1, the craft has not qualified.
  - 12.1.2. Striking a Buoy - If a craft strikes a buoy, a ten (10) second penalty will be assessed.
- 12.2. Solar Slalom
  - 12.2.1. Striking a Buoy - If a craft strikes a buoy, a five (5) second penalty will be assessed.
- 12.3. Sprints
  - 12.3.1. Disturbing Official Battery Markings - When batteries are inspected, they will be given official tags. These tags must not be disturbed. Competitors are allowed to use only the batteries inspected for their craft. Officials may assess penalties ranging from fifty (50) points to total disqualification.
  - 12.3.2. Obstructive Boating - Any Team that operates its craft in a manner that impedes the progress of another craft or risks the safety of another craft or of their own will receive a minimum penalty of fifty (50) points or may be disqualified at the discretion of the Officials.
  - 12.3.3. Striking a Buoy - If a craft strikes a buoy and remains in its lane, a five (5) second penalty will be

assessed.

- 12.34. Leaving the Course - If a craft leaves its lane, its run has ended and it must be shut down and may not re-enter the course or finish.

#### 12.4. Endurance

- 12.4.1. Disturbing Official Battery Markings - When batteries are inspected, they will be given official tags. These tags must not be disturbed. Competitors are allowed to use only the batteries inspected for their craft. Officials may assess penalties ranging from fifty (50) points to total disqualification.
- 12.4.2. Obstructive Boating - Any Team that operates their craft in a manner that impedes the progress of another craft or risks the safety of another craft or of their own will receive a minimum penalty of one lap per infraction or may be disqualified at the discretion of the Officials.
- 12.4.3. Striking a Buoy - If a craft strikes a buoy, the craft must execute a 360o penalty turn on the inside of the course prior to the completion of the Event.
- 12.4.4. Failure to Yield the Right-of-Way - Any Team failing to allow right-ofway when being overtaken by another craft will be penalized a minimum of 0.5 laps per infraction.
- 12.5. Paddling - Using paddles or oars to power the craft during any competitive event (other than to avoid becoming a safety hazard) will result in automatic disqualification.
- 12.6. Failure to Attend Morning Meetings - Any Team that fails to be properly represented at any Morning Meeting will be penalized and must receive a briefing before they can continue to compete.
- 12.7. Conduct - Officials may assess penalties ranging from ten (10) points to total disqualification for improper conduct. Such conduct may include, but is not limited to, improper language and obscene gestures.
- 12.8. Failure to Comply with the Rules - Officials may assess penalties ranging from one (1) point to total disqualification for a Team's failure to comply with any Rule.

### 13. Advertising, Promotion and Publicity

All advertising, sales promotion, and publicity material produced by the Teams or their sponsors concerning or referring to the Event shall refer to the Event Sponsor. By entering the Event, all teams shall agree to the use, without compensation, of their names and photographs in any publicity material that may be issued by the Event's Sponsor, the Organizer, and their associated companies.

### 14. Prizes and Awards

The Sponsor and Organizer of the Event will recognize all Teams' participation. In addition, the following awards will be presented:

- 14.1. Daily Award - Some awards may be presented at the Morning Meetings and some on Tuesday evening.
- 14.2. Overall and Runner-Up Awards - For each competition, an award will be presented to the Team that demonstrates the best performance. Runner-up awards may also be presented. An Overall Winner will be determined by a formula which includes: Technical Report, Visual Presentation, Workmanship, Qualifying, Solar Slalom, Endurance, and Sprint. Runner-up awards may also be presented.
- 14.3. Other Awards - Other awards may be presented at various times during the Event.
- 14.4. Award Ceremonies - An awards ceremony will be held on Saturday following the day's competitions.

### 15. Procedures

To assure that all competitors are in compliance with the Rules during the competitions, an "on deck" area has been established. There are some safety concerns that will be checked, and are subject to penalty. This, along with the "staging" area, is intended to expedite the conduct of the competitions. All Rules and procedures are written with the safety of the participants and spectators in mind.

- 15.1. All competitors must be in the "staging" area at least one hour before the competitions. Charging of the battery pack may occur during this time.  
As boats are moved from the "staging" area to the "on deck" area there will be a brief reinspection. No work can be done on the boats once the boats are in the on deck area.
- 15.2. The craft will be operated by a skipper at all times. No remote control operation is permitted.
- 15.3. Boats must be removed from the water if extensive repair work is required. Only minor repairs will be allowed on the water and must be done outside the course area. Boats left in the water must be reinspected before they compete in the next event.
- 15.4. At no time during the competition will a swimmer be allowed in the water to assist a boat. Wading is permitted only at the Launching Site – close-toed shoes are required (no sandals).
- 15.5. Protective eyewear must be worn at all times by anyone who is handling batteries. Close-toed shoes are required for all participants while working on a boat.
- 15.6. At the discretion of the officials, in order to give the media a good photo opportunity, the start of the Endurance heats may begin with a "Parade lap". There will be no passing until on the course.
- 15.7. Should there be a question regarding the meaning of Rules, the participating team will file their question in writing with the Registrar using a Rule Interpretation Form.
- 15.8. Teams are expected to be able to change configurations in one hour or less.

## **16. Paddock Area**

This is the area that is under large tents, where each entry will have an area of approximately 300 square feet. This area may have to be adjusted, depending on the number of participants. The area is used to work on and store the craft and for the Visual Display. Participants are encouraged to have School Banners or other identification. The area immediately outside the tent may be used for recharging.

## **17. On-the-water testing**

Because of restrictions at the Site, no on-the-water testing will be allowed.

## A

Absence of race number	206.03
Advance-programme	202
Aerial (boats with aerial propeller)	590
Age limit	203.04
Aid (first aid station)	205.08.02
Air Supply	509.20
Altering course	312.12
Anti-doping regulations	205.02.03
APBA recognised series	106.01
Appeals (protests and)	403/405
Approaches to the starting line	306.08
Arbitration	409
Authority (change of National)	109.02
Awarding of prizes	321

## B

Ballast	504.12
Base	300-604
Before the start	306.06
Blue cards	406.05
Boat starting before time	306.09
Boats (inflatable)	560
Boats (equipment)	504
Boats (fouling competing boats)	314
Boucquey Trophy	803
Buoy and course officers	201.07
Buyse Trophy	801

## C

Calculation of speed	605
Calendar	101
Cancellation of licence	109
Cancelled (race)	308
Cards (yellow)	406.05
Certificate (record)	615.08
Certificate (measurement)	501

Certificates (performance)	614
Championship (world)	107
Championships (continental)	108
Championships (general rules)	106
Change of date	101.04
Change of National Authority	109.02
Circuit	302
Circuit races (rules for)	300
Circulation of the result (record)	615.07
Classes (international series and classes)	500
Classes, sports outboards	540
Classes racing inboards	510-515
Classes eligible for records	601
Classes racing outboards	520
Classes racing outboards – Historic	545
Classes (monohull, outboards)	550
Classes Sport outboard	530
Classes Osy 400	525
Classes Pneumatic	565
Classes Diesel	570
Classes Turbo Sets	580
Classes Aerial Propellers	590
Classes Electric Powered Boats	595
Classes Inflatable	560
Clock	306
Cockpit (reinforced)	509
Clothing protection	205.11
Commissioner (UIM)	102
Committee (powers of the race)	201.01
Committee (organising, race)	201.01
Cost of measurement	501.01
Course (marks of the)	303
Crash boxes	509.21
Cups (international)	800

## D

Date (change of)	101.04
Deadline dates	101.03
Dead engine start	307
Dead-Heat	318
Deformable pickle-forks	504.02

Deputy Officer of the Day	201.04
Discs	306.02
Disqualification	406.04
Distinctive marks	206
Drag racing	950
Duties of the timekeepers	201.09
Duties of the Technical officers	201.07
Duties of the race Officials	201.06
Duty of the Deputy officer of the day	201.04

## E

Electric powered boats	595
Endurance races	902
Entries	108.04 - 203
Entry level racing classes	500.04
Environmental care	704
Equipment of boats	504
Event sanction	101.01
Exclusion	406.09

## F

Fee (entry fee)	203.03
Finishing line	316.02
Finishing a race	316
First aid station	205.08.02
Flag signals	304.02 – 312.09
Fouling marks	313
Formula Future rules	960
Fuel	508-514-519-524-525.3-534-544-550.7-564-569-574-584-594
Frontal Head Restraint device	205.05 - 205.07.01

## G

Gun	306.03
-----	--------

## H

Heats (races in several)	317.01
Helmet	205.07
Homologation of records	615
Homologation of engines	506



Homologation sheets	506.11-506.12-506.13
Hulls (inspection of)	502-607
Hydro Sprint racing rules	905

## I

Immersion training	205.05
Inboard racing displacement class	904
Inspection of engines & hulls	503-607
Insurance	205.09
Interested parties	402.02
International races recognised by the UIM	103-104
International series and classes	500
International cups	800
International officers	201.02
Interpretation of the rules	200.02

## J

John Ward Trophy	802
Jet Sprint Rules	901
Jurisdiction	400
Jury	201.01-402
John Hill Trophy	805

## L

Lapped driver	312.13
Licences	109
Lifting of race boats	205.12
Log book	501.11
Low emission engines	541.02-542.12-566.01

## M

Margin required (records)	606
Marks of the course (definition)	303
Marks of nationality	206
Marks (rounding)	312.11
Match race	307.05
Measurement certificate	501
Medical examination	205.01, 02, 03, 04
Medical Officer	201.04.01
Minimum age	203.04

Modifications allowed

525.2.02-533.10-543.09-550.6.07

562.10-563.10-568.12—568.10

Motor shut off switch 509.12

## N

National Authority (change of)	109.02
Nationality of the drivers	203.05, 206.01
Noise reduction	505
Non approved races	104
Number and value of the prizes	321
Number (race)	206.02

## O

Obstacle (definition)	300.01
Officer of the Day	201.03
Organisation of records	600
Organisation of races	200
Organising bodies	201
Outside assistance (radio)	205.07.02
Organising committee	201
Overlap, overtaking	312.02-08

## P

Passing marks	312.11
Penalties	406
Performance certificates	614
Piston motors	504.07
Pickle-forks	509.02
Posting of the results	209
Postponed (race)	309
Prizes (number and value)	321
Production changes (engines)	506.14
Programme (race)	204
Protection (technical)	205.10
Protests	403
Protests (and appeals)	405
Pseudonym	109.07
Publicity	203.051

## R

Racing instructions	204
---------------------	-----

Racing Vest	205.06-509.04
Race number	206.02
Race (stopping of a)	311
Race cancelled	308
Race postponed	309
Race shortened	310
Race (finishing a)	317
Races (rules for circuit)	300
Races recognised by the UIM	103
Races in several heats	317.01
Racing licences (rules)	109
Records	600
Record certificate	615.08
Record (circulation of the result of a)	615.07
Red Cards	406.05
Repairs	502 - 509.22
Report of the Commissioner	102.04
Reports	322
Result (circulation of the result of a record)	605.07
Results (position of the)	209
River Marathon Rules	900
Rotary motors	504.07
Rounding marks	313
Rules of the road	312
Rules (interpretation of the)	200.02

## S

Safety zone	306.05
Safety of the driver	205
Safety boats	205.08
Scoring system	317
Signals from the shore	304
Signals (starting)	304.02 – 312.09
Start (flying)	306
Solar racing rules	970
Solar splash rules	971
Start (dead engine)	307
Start	305
Starting (boat starting before time)	306.09
Starting in groups	304.03

Starting line (approaches to)	306.08
Stopping of a race	311
Super charging	504.09
Serieslicence	109.08
Super-licence	109.08
Suspension	406.05 - 406.07 - 406.08

## T

Technical Commissioner (functions)	102.02
Technical officers	201.07
Technical protection	205.10
Test (consumption of alcohol)	205.02.02
Throttle cut-off device (automatic)	504.03
Timekeepers and timing devices	201.09-301
Timing	301
Titled International events	105
Towing boats	205.08.01
Trophies	800

## U

UIM Commissioner	102
------------------	-----

## V

Value and number of the prizes	321
--------------------------------	-----

## W

Water registration	106.02
Windscreen	504.02
World championship	107

## Y

Yellow cards	406.05
--------------	--------



# **FORMULA 1 RULES 2022**

**PUBLISHED ON 22/12/21**

1. ORGANISATION
2. RACE FORMAT
3. START
4. STOPPED RACE
5. INTERRUPTED RACE
6. RACE COURSE
7. CLASSIFICATION
8. EQUIPMENT
9. FUEL
10. SUPERLICENCES
11. YELLOW CARDS
12. PROCEDURE FOR PROTESTS AND APPEAL
13. SAFETY
14. GENERAL

## **INTERPRETATION OF THE RULES - 200.02**

In all cases unforeseen by the international rules, the National Authority is to adjudicate, bearing in mind the spirit of the rules. In the case of conflicting rules, these rules concerning the Championship as published in the blue pages of the Circuit Rules Handbook, shall prevail.

### **1. ORGANISATION**

1.1. The rights of organization of Formula 1 races and championships are owned and ruled by the UIM which has granted the management of the competition to the UIM Council. The Council may update these rules whenever necessary on request of the F1 Daily Management Committee.

1.2. The Formula 1 daily Management Committee is responsible for the championship daily management. This committee is composed of the Promoter (1 vote), the Formula 1 Committee Chairman (casting vote), the team owners' representative (1 vote), and the drivers representative (1 vote only on safety issues).

The Formula 1 World Championship is governed solely by the UIM international rules for circuit racing, as published in the white and blue pages of the Circuit Rules Handbook.

1.3 With the agreement of the UIM, a Race Director can be appointed. The Race Director reports to the OOD. He assists the OOD in all duties and is entitled to impose penalties as the OOD and the UIM Commissioner.

1.4. New venues must be checked in due time before an event can be sanctioned, and an UIM commissioner must be appointed for each race

1.5. A Formula 1 Protest Judge will be nominated for each event and will adjudicate on all protests. The protest judge must be named in the advance programme.

1.6. The Officer of the Day must speak fluent English. The following officials have to be Club, NA or UIM officials:- O.O.D., deputy O.O.D., safety officer, technical officer/scrutineer, time keeper, pit marshal; pontoon marshal and starter.

1.7. It is strictly not permitted to grant club-membership for the duration of the race meeting to interested outside parties.

1.8. The UIM flag must be flown from a prominent position at each event.

1.9 The allocation of the paddock positions shall be made on basis of the Teams' sporting merit and with due consideration of the Promoter's contractual commitments as well as respecting the preference for the Team of the organising city and/or country.

## 2. RACE FORMAT

- 2.1. Each Formula 1 meeting counting towards the drivers World Championship will take place over a period of two or three days in accordance with the full UIM Circuit Rules for racing, classification, protests and appeals and the specific rules listed below.

Day 1	12.00 - 12.30 hrs	Documentation and registration
	10.00 - 18.00 hrs	Technical scrutineering
Day 2		Boats and all racing equipment (including racing gear of the driver) must be in the pits 24 hours before starting the technical scrutineering (fine if not present)
	09.00 hrs	1st Driver's briefing (compulsory for all drivers and radiomen and team managers of each boat) at the race headquarters (fine if not present at the roll call)
	10.30-11.30 hrs	Free practice
	15.00-16.00 hrs	Timed trials
Day 3	09.00 hrs	2nd Driver's briefing (compulsory for all drivers and radiomen and team managers of each boat) at the race headquarters (fine if not present at the roll call)
	10.30-11.30 hrs	Free practice
	14.45 hrs	F1 Powerboat Parade Lap.
	15.00 hrs	Formula 1 Grand Prix - Duration not to exceed 60 minutes
	16.00 hrs	Prize giving ceremony

If there is a change to the racing course layout, there may be extra free practice.

- 2.2. No entry shall be considered official until the boat has passed scrutineering and the documents are checked. Only one boat per driver is allowed to be entered for any championship meeting. Spare hulls and engines are allowed but may be used only as foreseen in the Formula 1 rules.
- A spare boat is defined as a back-up boat and not to be tested along with another boat to determine the best boat to race. The primary boat entered is the boat to be raced, unless the primary boat becomes damaged and is unable to be raced.
- 2.3. If force majeure causes one of the two time trial sessions to be cancelled the results of the other session will still stand. In the event that less than 50% of the other session is run, then the grid positions will be established using the current championship positions.
- 2.4. Establishment of start-grid positions from the time trial(s).
- 2.4.1. All drivers must participate in the timed trial.
- 2.4.2. Q1: All boats may run laps at any time during the first 22 minutes of the hour. Timing of the boats will start 2 minutes after the green flag. At the end of the first 20 minutes, only the fastest 12 boats will remain in the water, the excluded boats will fill the final grid places.
- Q2: After a seven-minute break, the times will be reset and the 12 remaining boats will then run in a 15- minute session - again they may complete as many laps as they want at any time during that period. At the end of the 15 minutes, the 6 slowest boats drop out and fill places 7 to 12 on the grid.
- Q3: The top 6 boats will run individually a two lap timed trial for their start position.
- If a driver is deemed by the officials to have stopped unnecessarily during Q1 or Q2 on the circuit or impeded another driver during qualifying, his times is to be cancelled in the relevant session.
- No refuelling allowed during timed trial.
- 2.4.3. Alternative time trials procedure. The duration will be one hour. No limit of laps per boat. Refuelling is not allowed. Boats not respecting the rules on the water, the best lap will be deducted at the end of the session. In case two or more boats have the same time, second best lap will be taken as final qualifying order. If the time trials are cancelled the grid positions will be established using the current championship positions.

- 2.4.4. Any change of boat, or internal parts of the engine, after the time trial begins means starting at the end of the grid (only 1 engine to be used for both time trial and race). Any engine changed after time trial will be sealed by the UIM technical commissioner and will be checked for legality and the driver will start at the end of the pontoon.
- 2.4.5. If more than one boat is relegated to the end of the grid, their position will be terminated by qualification time i.e. : slowest qualification time last on the grid, 2nd slowest 2nd last on the grid etc.
- 2.4.6. If two (or more) boats have the same best lap time during the timed trials, these boats will be awarded start positions based on the better of their second best times.
- 2.5. The official practice schedule will be posted at race control.  
Testing outside the race circuit and before or after authorised hours is prohibited during the event.
- 2.6. In case of force majeure, this format may be amended by the O.O.D. and the two commissioners.  
If a race is shortened due to force majeure, it is at the discretion of the O.O.D. and the UIM commissioner to alter the time table, and if necessary the course layout accordingly.  
If the race is declared to be on rough water, the number of laps should ideally be maintained, but may be reduced if seen fit by the UIM Commissioner. If time permits, the circuit layout can be changed, as agreed by the commissioner and the drivers representative.

## QUALIFICATION PROCEDURE

- 2.7. The maximum number will be 26 for the race, unless decided differently by the UIM Commissioner and the Promoter and announced at the first briefing.  
If more boats are entered for the race, the series contracted boats will automatically have access to the official practice and the timed trials. All other boats will participate in a 30 minutes pre-qualifying which will take place in the morning of Day 1 one hour before free practice; the fastest boat will be allowed to participate in the official practice and timed trials, bringing the number to a maximum of 26. If necessary, the non-qualified boats must leave the paddock area.
- 2.8. The UIM Commissioner reserves the right to place one non-qualified boat in the final event. National drivers from the country hosting the event or a driver selected by the promoter will be eligible. The wild card driver will be announced at the first drivers' meeting.
- 2.9. Before the race, a briefing must be held to examine the main points of the race. The attendees of the meeting, and the agenda, must be in accordance with the rules of the UIM.
- 2.10. The UIM Commissioner must ensure that there is a roll-call of names of drivers, radiomen and each one must respond with his assigned racing number. If the driver is not present to respond when his name is called, a financial penalty will be imposed.

## 3. START

- 3.1. The start shall be a dead-engine jetty start as described in rule 307, bearing in mind the following
- To increase the length of the pontoon to come close to 5 metres space per boat. This would leave more space to maintain the lanes.
  - To incline the pontoon (or change the location of the first buoy) sufficiently not to have the pontoon straight on the first buoy.
- In case these points are not feasible, the alternative will be a rolling start upon decision of the UIM Commissioners. Also the Commissioners will apply stronger penalties for drivers not maintaining their lane.
- 3.2. Boats should be drawn up with dead engine, stern first to a jetty, floating pontoon, or beach. Exception for four stroke engines with friction clutches may be started at the one minute count-down and run a maximum of 1800 RPMs which will be monitored for the start. Boat which do not line up with the boat next to them within 20 seconds of being requested to do so will be penalised financially.
- 3.3. The distance between the starting line and the first turning buoy must be at least 300 m considering all safety aspects.



- 3.4. When the Pontoon Marshal is satisfied that all drivers are ready to start, with engines stopped, he will raise a green flag and the O.O.D. will initiate the start procedure, by instructing the starter to raise the 30 seconds board (min. 80 x 80 cm, figures 60 x 10 cm).

Once the 30 seconds board has been raised those drivers starting their engines or leaving the pontoon before all red lights are switched off, will be penalised one lap. This lap may be deducted at the end of the race or a drive through penalty may be imposed. 30 seconds after this board is raised all red lights will be switched on. Between 5-15 seconds after that, all red lights will be switched off and the race starts.

After a period of time the red light will be shown again.

- 3.5. Late starters: A driver who has failed to start before the red light is shown again, must wait until the whole field has passed the start pontoon before he may join the race through the entrance lane to the course.
- 3.6. The starter may decide, if he judges it necessary, to cancel the start by showing the red flag and recommence the starting procedure.
- 3.7. The start jetty or pontoon must be minimum 75 m long or be equal to 5 metres multiplied by the maximum number of boats permitted to race, (whichever is the greater) and must be at least 1.5m wide.

The alignment of the start pontoons must be such that the pole position has the maximum advantage towards the first turn buoy, compared with the last positions on the starting grid. The plan of the circuit (including the position of the start pontoon) must be sent to the UIM office 60 days in advance of the race date for approval.

- 3.8. Any boat(s) not starting may be returned to the pontoon either by the driver's own efforts or may accept outside assistance. The boat(s) will be able to restart the race after passing technical inspection and approval of the technical commissioner. Boat(s) must safely enter the race course through the entrance lane. Any crew member swimming out to a boat will cause his entry to be disqualified.

Only uniformed crew who are Formula 1 team members with Formula 1 passes designating pit starting pontoon admittance will be allowed on the starting pontoon.

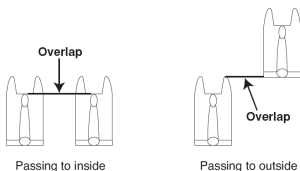
3.8.1 Any boat(s) that stops on the course, spins out, or is involved in an accident that causes a yellow flag, and can return to the pontoon without outside assistance, will be inspected by the technical commissioner, and if approved, will be able to re-enter the race through the entrance lane.

3.8.2 No F1 boat(s) will be allowed to use rule 311.01.4 to race under protest.

- 3.9. The start procedure may be changed in order to separate the boats into two groups from the start until the first buoy by guiding the drivers through 2 different gates marked with 2 large buoys ahead of the first turn buoy. The daily management committee will decide whether to apply this system and full details on the starting system will be given at the drivers briefing.
- 3.10. An overlap may only be established when two boats are on the same course or approximately on the same course and the cockpit of the overtaking boat, if passing on the inside is level with the cockpit of the overtaken boat.

When overtaking from the outside, an overlap is established when the overtaking boat has passed the overtaken boat sufficiently to alter course without contact.

When trying to overtake a boat on the inside the driver must anticipate the possible direction of the boat it is trying to overtake and must take all necessary action to avoid a collision (see drawing)



## 4 STOPPED RACE

- 4.1. In the event of the race being stopped, boats must return under their own power to the start pontoon [or other position on the circuit notified by the UIM Commissioner during drivers' briefing]. Alternatively, the yellow flag may be shown and all drivers will continue at slow speed with no overtaking.
- 4.2. Boats that have broken down and received outside assistance by being pulled to the infield or off the race course will be towed to the launching pontoon only during a «race stop» condition and if pick-up boats are available.
- 4.3. Repaired boats may rejoin the race at any time upon approval of the UIM technical commissioner as directed by the pontoon Marshal. Further definition of the repair areas will be given at drivers briefing.
- 4.4. No repairs are allowed on the start pontoon during the line-up and start or re-start procedure.
- 4.5. Drivers may carry-out their own repairs on their boats in accordance with the rules. The driver's two nominated pontoon mechanics and the official crane driver do not count as outside assistance.
- 4.6. In the event of a restart, a boat being repaired must be ready to take its position on the grid as directed by the pontoon Marshal. If the boat is not ready to take its position, it must start at the end of the pontoon.
- 4.7. The re-started race distance will be the original race distance minus the total number of laps completed by the leading boat at the time of the stoppage, minus also 1 lap per re-start.
- 4.8. Starting positions for restarts, or final classification if there is no restart, will be determined by the order at the end of the lap prior to the race being stopped.
- 4.9. The race organiser may at any time determine who was responsible for a race stoppage, even after the race is finished; in which case the guilty driver[s] will be disqualified from that race.
- 4.10. It is mandatory that all boats have remote controlled red and yellow lights in their cockpit. It is the drivers' responsibility to ensure that these lights are functioning and that they are clearly visible to the driver whilst racing.
- 4.11. In case of a race stop, the rescue boats and race control will show the red flag and race control will switch on the red light in the boats.  
At this signal all drivers must immediately slow down and return to the starting pontoon, or the previously defined re-start area.
- 4.12. The decision and procedure to have restart from pontoon or from milling area will be announced at the drivers' briefing.

## 5 INTERRUPTED RACE

- 5.1. The position of the boats for the restart will be that of their racing order on the lap before the yellow signal was given. Boats which do not restart in their correct position may be given a one lap penalty or a drive through penalty may be imposed.
- 5.2. When the yellow flag is shown, the leading boat will act as pace boat, and run at slow speed. The leading boat's radio man shall stay next to the UIM Commissioner and transmit the instructions to the driver. The yellow flag will be used by race control and the rescue boats to indicate a hazard when displayed stationary, and extreme caution to be exercised by drivers when waved vigorously.
- 5.3. The Organiser may interrupt the race for any reasons of safety or emergency services access, and in which case the rescue boats and race control will show yellow flags and race control will switch on the yellow lights in the boats.  
At this signal all drivers must immediately slow down and not overtake. Any overtaking, 5 seconds after the yellow signal has been given, will be penalised by 1 lap unless instructed by the O.O.D. or UIM Commissioner to change position of the rolling restart.
- 5.4. When the race course is clear, only the yellow flag at race control will be continued to be shown.
- 5.5. All boats must maintain their position at slow speed (approx 4000 rpm) until race control raises the green flag signifying the restart of the race. It is the responsibility of the team managers to ensure that their boat(s) are at the correct position at the restart.

- 5.6. When a rolling start is used, if minimum the first 10 boats are in their correct position, the UIM Commissioner can restart the race using the timing screen or the green flag.
- 5.7. During the yellow signal situation, a boat may leave the race course but must re-join the race behind the boat running in last position.
- 5.8. If an accident occurs 3 or fewer laps before the end of the race, the UIM Commissioner will end the race by giving the checkered flag. The final positions shall be determined by the running order of the previous lap, minus any boats that caused the stoppage of the race.
- 5.9. If a yellow flag condition starts 5 laps before the end of the race, the race shall be extended by 5 laps after the green is given.
- 5.10. If the race will exceed the maximum duration of time while under the yellow and a restart is not possible, the UIM Commissioner shall 'freeze' the results as the running order (under the yellow) and the boats shall cross the finish line after one more lap, taking the checkered flag.

## 6 RACE COURSE

- 6.1. The length of the straight between any 2 turning buoys is to be a maximum of 850 metres.
- 6.2. There must be a minimum of 2 cranes for launching boats.
- 6.3. The boundaries of the water on which practice and racing are allowed to take place must be defined in the advance-programme.
- 6.4. The pit area should be sufficiently large to prevent boats being craned into the water over other boats.
- 6.5. Safety rules shall be those of the UIM applicable on the date of the race unless specified otherwise by these rules.
- 6.6. Right hand turns can be inserted on the race course.  
In order to avoid any confusion, left hand turns will be marked by orange buoys and right hand turns by yellow buoys.

## 7 CLASSIFICATION

- 7.1. The boat placed first will be the one having covered the scheduled distance in the shortest time.
- 7.2. All boats will be classified by taking into account the number of complete laps that they have covered and for those which have completed the same number of laps, the order in which they crossed the finish line.
- 7.3. The number of laps completed during restarts will be taken in account for the classification.
- 7.4. Points will be awarded to the first 10 classified drivers crossing the finish line under their own power, on the condition that they have completed at least 70 % of the number of laps covered by the winner (rounded up or down in a mathematical way e.g.  $18.5 + = 19$  and  $18.49 = 18$ )
- 7.5. Boats that complete 90% or more of the race distance, but do not cross the finishing line after the winner has crossed the finishing line, will be classified after those boats that have done the same number of laps but that also cross the finishing line after the winner.
- 7.6. To be awarded full points, the leading boat must have completed 70 % of the number of laps counting for the race.
- 7.7. If a stopped race cannot be restarted due to «Force Majeure», points will be awarded in accordance with the following scale:

70% or more of the total race completed	Full points
less than 70 % completed	Half points
less than 35% completed	No points

## 7.8 Finishing points scale for each race :

First	20	points
Second	15	points
Third	12	points
Fourth	9	points
Fifth	7	points
Sixth	5	points
Seventh	4	points
Eight	3	points
Ninth	2	points
Tenth	1	point

- 7.9. The overall classification for the Formula 1 Drivers' World Championship shall be established by the addition of all points obtained by each driver in each of the races counting towards the championship.

The points are personal and are not allocated to the team. Each driver scores his own Championship points. If a driver changes team during the course of the season, he keeps his points.

- 7.10. In the case of a tie, the number of first places in these races shall be considered, then the second places, etc.. When total points are the same and all listed Tie Breakers have been exhausted, the Driver with the most pole positions will be declared the Winner. This procedure will be carried out to 2nd position on the starting dock and further if needed.

- 7.11. Immediately after the race:

The winner may complete a lap of honour

Top 3 finishers must have priority at the pontoon to be able to reach the podium within 15 minutes.

- 7.12. Presentation of trophies to first 3 drivers on the official podium. This presentation is only based on a provisional classification, and is subject to confirmation after scrutineering and consideration of any protests or appeals.

- 7.13. At the last race of the series UIM will provide 3 medals (gold, silver, bronze) to be given to the first three in the overall classification of the World Championship.

These medals do not replace the normal prizes (art. 108.01 and 321).

## 8 EQUIPMENT

### HULL

- 8.1 The hull is free for each of the three capacities but must conform to the Formula 1 rules.
- 8.2 Hull, sponsons, and powerhead replacements and other parts are allowed after scrutineering, up until the start of the timed trial, but any changes to be made must be immediately notified to the UIM technical Commissioner for re-scrutineering and sealing and technical inspection of units removed.
- 8.3 Any replacement of boat or sponsons after qualifying time trials will result in all previous times achieved being cancelled, and the replacement boat or sponsons will be considered as a new entry, requiring full scrutineering. If no timed practice opportunity remains, the boat will start from the end of the grid.
- 8.4 Repairs are allowed at any time during the race weekend with the exception that the replacement of hull, sponson, crankcase, or cylinder block, is not permitted after the start of the race. Repairs are not allowed on the race course using outside assistance.

- 8.5 The weight of the boat, including residual fuel and oil, the driver with personal equipment, but excluding loose water is:
- |                       |                                  |
|-----------------------|----------------------------------|
| 2.0 liters            | 486 kilogrammes                  |
| 2.5 liters            | 550 kilogrammes                  |
| 3.0 liters            | 586 kilogrammes                  |
| 3.5 liters – 4 stroke | 600 kilogrammes                  |
| 4.6 liters – 4 stroke | 600 kilogrammes (to be reviewed) |

The first six classified boats will be weighed with scales after time trials and the race. The weighing of the boats cannot be protested. The scales will be available before the meeting commences.

## PARC FERME

The top three finishers of the timed trials and race must immediately take their boats to the UIM tent, without stopping on the way and without touching, replacing or modifying anything. Not complying will bring immediate disqualification.

After the shoot out and the race, the drivers qualified in 4th-5th-6th positions are to wait in the water or at designated area until the top three finishers have been approved and the UIM Commissioners dismiss them.

Upon request of the UIM Commissioner, drivers must allow to be weighed separately.

- 8.6 The minimum length is 5m10 for all three capacities. The length must be measured as the overall length of the hull between perpendiculars at the foremost and aftermost rigid part of the hull including deformable pickle-forks. Measurements are taken while the boat is ashore.
- 8.7 Radios in boats are mandatory and a full radio check of each boat will be part of technical scrutineering in order to guarantee that all radios are working. The radioman must be present at race control whenever his boat is on the course. In order to guarantee clear communication between the Radiomen and the UIM Commissioner, all Radiomen must speak English.

If team manager is unavailable, the assistant team manager must be in the pit area all time for any communication with the UIM Commissioners; team manager and assistant team manager both of them must speak English.

- 8.8 Each wing mirror must have minimum size of 60 sq. cm and be bolted on 2 points to assure proper mounting. Within one team, two identical boats must have different colours of mirror bodies as follows: Odd number: yellow fluorescent colour;  
Even number: orange fluorescent colour; Third boat of the team : black.

## ENGINES

### TECHNICAL RULES

1. A grandfather rule applies for all Formula 1 outboards that were homologated and eligible to compete up to and including the 2003 season. These engines are :
2. Mercury 2.5 EFI Homologation sheet No: F-1/00496
3. Johnson 3.0 EFI Homologation sheet No: F-1/00497
4. These engines will continue to be eligible for as long as they are competitive; they will be governed by their original homologation sheets supplied when new. These grandfather units will be taken as the performance benchmark for newcomers, with an objective of a nominal 350 hp performance ceiling. Modification of the OEM mapping in the Electronic Control Unit is not permitted.
5. The Formula 1 management committee reserves the right to review four stroke or new two stroke engine performance at mid-season in the event that one or the other is too performant within the meaning of these rules. If deemed appropriate, they will modify the diameter of the engine's induction restrictor. A four week grace period will be allowed for modifying and fitting the restrictor plates, from the date of announcement of the change.

6. These technical specification for Formula 1 racing engines permit the engine [ comprising of the power- unit, drive-line, propshaft, mounting system, steering, hydraulic, and electrical controls ], to be installed as an outboard, inboard, or inboard / outboard, in any drive configuration. Lower units converted to single drive-shafts are NOT permitted.
7. Formula 1 boats must be water propeller driven, no airscrews are permitted.
8. Formula 1 engines must have a fixed ratio direct drive. Variable ratio gearboxes are not permitted.
9. Atmospheric induction engines with a maximum of 8 cylinders, will be admitted up to 3.0 litres nominal capacity two stroke; 4.6 litres 4 stroke; grouped into the following measured engine capacity ranges :
 

2.0 liters	measured capacity 1950 to 2200 cc
2.5 liters	measured capacity 2101 to 2600 cc
3.0 liters	measured capacity 2551 to 3200 cc
3.5 liters	measured capacity 3400 to 3600 cc
4.6 liters	measured capacity 4500 to 4700 cc
10. Forced induction engines with a maximum of 6 cylinders will be accepted with an equivalent capacity calculated by multiplying the measured capacity by 1.4. The maximum measured engine capacity admitted will be nominally 2 litres, hence:
 

2.0 liters	measured capacity 1200 to 1575 cc equivalent to 2200 cc
2.5 liters	measured capacity 1501 to 1860 cc equivalent to 2600 cc
3.0 liters	measured capacity 1822 to 2290 cc equivalent to 3200 cc
11. Power units may be of any internal combustion design, of limited or series production.
12. Rotary motors will be rated in accordance with rule 503.08.
13. Diesel, external combustion, or gas turbine engines are not eligible.
14. 'Green engines' are to be encouraged [with respect to emissions] through incentives determined from time to time by the Formula 1 committee.
15. Engines must be capable of being silenced. If a particular race organiser requests it for local reasons, rule 505 will be applied and engines must not exceed a maximum decibel rating of 98 +6 db(A) when measured as rule 505.03.
16. If silencers are required to conform to the maximum noise rating, it is mandatory to have them available at all races. Compliance is required for scrutineering clearance.
17. To reduce environmental pollution, running-in of engines at the launch jetty or other specified area, will only be permitted by the Technical Commissioner and, if required by the Technical Commissioner, effective mufflers must be used
18. Non-compliance with noise regulations will be financially penalised.
19. New engines will be accepted provided the engine/drive units are submitted for verification, the spirit and letter of the performance target of these rules is respected, and they are freely available to be purchased at a price approved by the F1 Daily Management Committee.
20. To qualify, the manufacturer must present a complete power-unit assembly for verification by the UIM technical officer or delegate nominated by the F1 Daily Management Committee.
21. Manufacturer name and colour must be used as homologated.
22. Running production changes will be accepted only once per year for the crankcase / cylinder assemblies, and notification must be received by October 15th of each year. Running production changes for all other components may be submitted for approval at any time. Legality for use will be considered by the Formula 1 committee, taking into account any affect the change will have on performance. If accepted, changes will be effective immediately after approval, and will be conditional that the affected components are freely available at a reasonable price.
23. In the case of an engine proving to be illegal, penalties will be imposed in accordance with rule 406- Penalties

## 24. TECHNICAL RULES FOR MERCURY RACING 2.5 EFI TWO STROKE ENGINES:

1. Flywheel is free but trigger pickup magnet must have two poles and the quantity of stator magnets must be the same as in original flywheel.
2. Exhaust attenuator must be made of aluminum alloy and in compliance with homologation dimensions and OM shape
3. Stator, trigger, ignition coils, switch boxes, engine harness and air temp sensor must be original. The EFI ECU box will be provided by technical commissioners. While the engine is running only the original weather cap can be plugged into the ECU diagnostic port. The high voltage spark plugs wires are free. The starter relay is free, but must be mounted in the original position. The rectifier/voltage regulator in the battery charging system may be replaced by any rectifier/voltage regulator which can fit the original mounting plate.
4. The fuel rail, injectors, bypass T-fitting must be OM. The fuel pressure regulator must be single, OM and working. Use of any additional equipment that can affect the fuel system performance is illegal.
5. The engine cowlings are free but the overall shape of the top cowling must be the same as original one, there will be no connection between engine top cowling and power-head.

No air-box allowed. Mercury logo is not compulsory and the engine cowling color and graphics are free

6. Cylinder block (block, heads, exhaust cover, all inner mechanical parts) must be OM by Mercury Marine. The 822230A47 cylinder block can also be used, and it must be in compliance with the dimensions specified in the F1/00496 homologation sheet. No spacer allowed between cylinders block and exhaust cover. Sleeves, connecting rods are free, but in compliance with the homologation dimensions. Pistons are free but with the same number of piston rings and in compliance with homologation dimensions.

Cylinder block casting can be modified but without changing the engineering or designing structure both inside and outside, except the exhaust chest area. The next cylinder blocks casting can also be used with limitations described below: 858961A8, 858961A10, 858961A21, 858961A23, 858961T18, 8M8027364, 858961A35, 858961T02, 858961A28, 858961A17. The front crankcase cover must be replaced to appropriate one (from 822230A47 or original 2.5L Mercury EFI cyl. block). The sleeves must be replaced and be in compliance with the dimensions specified in the F1/00496 homologation sheet.

The lubrication ports of the multi-port lubrication system must be blocked.

7. Air intake system can be modified with the following limitations:
  1. The number of reed slots per one reed block is 14.
  2. The throttle body must be SVS Brucatto style construction.
  3. Four additional dimensions will be measured outside:
    - a) port width, port length for cyl.1&2, 3&4, 5&6.
    - b) The dimensions are: W – 119mm, L1/2 – 16mm, L3/4 – 42mm, L5/6 – 80mm.
    - c) The tolerance for these dimensions is  $\pm 2$ mm.
8. Mid-section must be OM by Mercury Marine. It is forbidden to use inside the mid-section any extra parts and devices that can affect the exhaust attenuator's performance. It is allowed to drill the mid-section to install additional equipment such as exhaust muffler, lift sender, etc. But the quantity of drilled holes must not be more than 4 and the diameter not more than 10mm. each.

One additional dimension will be measured: overall length of the mid-section. This dimension is – 305mm. The tolerance for this dimension is  $\pm 1$ mm.

9. Gear case housing must be OM and comply with inspection template. The overall preload of the gear case must be not less than 0,5 n/m at the time of inspection (without impeller). The use of OM impeller is mandatory.

10. All engines built with 822230A47, 858961A8, 858961A10, 858961A21, 858961A23, 858961T18, 8M8027364, 858961A35, 858961T02, 858961A28 or 858961A17 cylinder blocks must be inspected and approved by the Technical Commissioner before getting them in use. No compliance, disqualification applies.
11. Any technical development not covered by the existing rules must be declared before the technical scrutineering and must obtain the approval of the Commissioner in charge of the scrutineering before getting into use. Non compliance, disqualification applies.

## **25. TECHNICAL RULES FOR MERCURY RACING COMPETITION 360 APX Four-Stroke Engine**

### **1. Engine Hardware**

- 1.1. The required four-stroke engine for Formula1 is the Mercury Racing 360 APX engine, homologation number to be published on UIM website.
- 1.2. All engine hardware must be stock, as delivered by Mercury Racing.
  - 1.2.1. All hardware must be as per the official homologation document.
- 1.3. Modification and/or relocation of factory engine sensors is prohibited.
- 1.4. All engines will be equipped with tamper-proof seals at the Mercury Racing factory. If an anti-tamper seal is removed during post-race engine inspection, a new seal must be applied by a UIM official and the log book updated with the new seal serial number.
- 1.5. Specific components that will be sealed will be listed in the engine homologation.
- 1.6. Components provided with the engine but mounted within the boat (i.e. fuel supply module) cannot be modified.
- 1.7. No additional connections or ducting between the engine cowling and throttle is allowed.
- 1.8. The cowling must be as supplied by Mercury Racing. Additional graphics and/or alternate colors are allowable on areas specified in the engine homologation file only.

### **2. Propulsion Control Modules (PCMs)**

- 2.1. PCMs for use at a competition event will be held by the competitors. The serial numbers of each PCM and which boat they have been designated for shall be recorded.
- 2.2. At any time, a UIM official may collect a competition PCM for the purpose of checking the calibration for modification.

### **3. Controller Area Network (CAN) Data Logging**

- 3.1. Mercury Racing will provide a CAN interface for the purpose of logging ECU data to verify correct and unaltered operation of the engine during competition. The logger may be combined with the existing logger(s) used by the team.
  - 3.1.1. Teams shall provide at least one available port on a SmartCraft junction box for use of the logger, and it must be readily accessible.
  - 3.1.2. Teams shall provide a specified data logger to interface with Mercury's provided CAN interface module.
  - 3.1.3. The data logger will log PCM sensor data and other channels as defined in the homologation document.
- 3.2. Any devices attached to the Mercury SmartCraft bus shall be for measurement purposes only, such as data loggers and boat displays. Any attached devices are subject to inspection by sanctioning body officials. Purposeful modification of SmartCraft signals is prohibited.

### **4. Post-race inspection**

- 4.1. Top finishers from each race are subject to a post-race inspection per UIM guidelines. Any of the following areas may be checked:
  - 4.1.1. Engine electrical harness shall be visually inspected for modifications or repairs.



4.1.1.1. No harness modifications allowed

4.1.1.2. Any repairs from incidental damage must be tracked in official log book(s) and approved by sanctioning body officials.

4.1.1.3. Repairs must be inspected and approved prior to a competition event.

4.1.1.4. Camshaft Inspection per homologation specs – note, this requires removal of a tamper proof seal. After inspection, a new seal must be installed by a UIM official and the serial number recorded in the log book.

4.1.2. Visually inspect all hardware seals for tampering and serialization

26. All F-1 propellers must be made of a material containing at least 50% iron by weight (a ferrous material); the use of any and/or all exotic (<50% iron) or non-ferrous materials, including titanium, is prohibited.

## POST-RACE SCRUTINEERING

- The measurements registered on the homologation sheet will be used as a reference for technical verification of the engine's legality. All dimensions given are absolute maxima [ or minima, as the case applies ] and no tolerance is given. The Original Equipment Manufacturer will build engines that are within the dimensions and conform to the homologation. The absolute responsibility will be passed onto the driver, at time of sale, to ensure that the engine maintains its legality irrespective of whatever maintenance or setting-up work is carried-out on it. Technical scrutineering will be carried-out using manufacturer produced gauges handed over at time of homologation to the UIM These gauges will be used on a 'GO', 'NO-GO' basis. If the gauge does not go the dimension is legal.
- The technical commissioner at each event will decide the degree of dismantling for inspection to be carried- out on the first three classified entries, and his decision will be final.

## 9. FUEL

- 9.1. Official fuels will be available from the Promoter / organiser at each race venue.

As from 2010 onwards, at least 10 % of the fuel composition must be bio-fuel if that type of fuel is available (Bio-ethanol and alkylates).

It will be of a continuously consistent specification and quality ; conforming to the data sheet and samples issued at the beginning of the season and agreed between the UIM, the Promoter and the Engine Manufacturers.

Only this fuel will be used; teams bringing their own fuel to the race venues will be penalised.

- 9.2. Fuel samples taken at random from competitors during the event will be tested at the race venue and may also be analysed afterwards at a laboratory.

Drivers disqualified for fuel infringements will have to pay all laboratory testing and analysis costs.

- 9.3. The only permitted addition to the fuel is lubricating oil for two stroke motors. The use of additives aimed at increasing the power of the motor is prohibited to either the fuel (carburant) or the air intake (comburant).

- 9.4. No chemical starter aids are permitted on the start pontoon.

- 9.5. All participants are subject to thorough inspection at any time. The entire fuel system may be disassembled, removed from the boat and inspected and/or fuel samples taken. The presence of illegal fuel, at any time, on the onboard fuel system will result in immediate disqualification from that part of the race.

The legality of the fuel is to be adjudicated solely by the UIM commissioner, based on all tests and information available to him.

- 9.6. No refuelling will be allowed when the boat is not on its trailer.

## 10. SUPERLICENCES

- 10.1 A super licence is required for Formula 1 together with the NA international licence. No other membership is required.
- 10.2 A driver who exceeds 50 years of age in the season for which he is applying for a Superlicence, must produce the medical certificate including all detailed examinations which will be submitted to a doctor approved by the UIM.
- 10.3 The nationality of a driver is the nationality of the N.A. which issued the international racing licence to the driver. Medical and immersion tests can be done in other countries if the issuing N.A. agrees.

The flag is the one of the issuing N.A. of the international licence as above. The request for the UIM Superlicence must come from the N.A. which issues the international racing licence.

- 10.4 Drivers must hold a UIM superlicence before entry will be accepted.
- 10.5 Any new driver must be vetted during practice by the two UIM Commissioners and the Formula 1 drivers representative to the UIM.
- 10.6 To obtain a superlicence, a driver must have participated in 6 circuit races using a catamaran type hull (750 cc minimum) or a hydrocat (500 cc). Definition of a race during a race weekend, even if several heats are taking place, is that the race weekend with all heats or races is counting for one race only. The National Authorities are fully liable for the sports c.v. they submit for their drivers. The full race results of each race must be supplied since the drivers must have done at least 6 races with 70 % of the total distance of each race event.

The superlicence is provisional for the first 10 races and can be withdrawn at any time during the first 10 races by a committee composed by the O.O.D., the Formula 1 Commissioner and the Drivers representative.

During the provisional 10 races, the yellow card may be issued as a cautionary statement. When a second yellow card or a red card is issued, the provisional superlicence will be withdrawn for the remainder of the current racing season.

An anthropometric check of data reported in the Superlicence application may be carried on at any event during the relevant season by a UIM appointed Medical and/ or Anti Doping delegate. In case the Driver's data would not be anymore within the mandatory parameters, the Superlicence will be immediately withdrawn.

When a provisional superlicence is withdrawn, re-application can only take place for the next season. The decision on all matters concerning superlicenses is final and cannot be protested or appealed.

- 10.7 The application for a superlicence must be made by the National Authority of the driver concerned and lodged with the UIM 4 weeks before the first event the driver wants to participate in. The superlicence fee will be doubled for applications received beyond the 4 weeks deadline.

NO application will be taken in consideration within one week from the following event. The application must be accompanied by:

- The sports career of the driver, mentioning the results obtained in the qualifying events;
  - UIM medical documents, as per appendix to these rules, giving the information required by the UIM rules 109.09 / 109.10 / 109.11;
  - General Recommendation for F1 superlicense holders concerning physical fitness;
  - Cardiovascular training (endurance training) as jogging, cycling, rowing etc. twice a week - minimum 20 minutes without any interruption. Any sports activity which has "stand still" during the activity such as soccer, tennis or any ball sport is not suitable for the endurance training, but recommended as additional training;
  - Training to build up muscles for neck and back at least twice a week;
  - The immersion certificate (ref 205.05);
  - A photograph;
  - The superlicence fees are fixed by the UIM Council and paid to the UIM Secretariat. Superlicence fee fixed to 400 euro. For late application, the superlicence fee has been fixed to 800 euro and must be paid to the UIM Secretariat;
  - Medical expertise fee for drivers over 50 years in the season : 200 euro;
  - The digital version of the rulebook will be made available to the driver along with the superlicence.
- The National Authorities are responsible for the information given.

- 10.8. Superlicence sport documents application will be examined by F1 Daily Management Committee who will advise the UIM Secretariat on its acceptability.
- 10.9. The superlicence will be valid for 1 year (from January 1st or from the date of issue to December 31st).
- 10.10. For renewal of superlicences, the National Authorities must, before the end of December, send the UIM a list of the drivers for whom a renewal for the following year is required.
- 10.11. Each team will appoint one team manager who will be responsible for obtaining a team licence from the UIM for his team, as well as ensuring that the drivers obtain their superlicences from their N.A.'s. He will also be responsible for enrolling his two boat team in the Championship and for all dealings (contractual, financial) with the UIM and IDEA MARKETING.

He will also be responsible for the behaviour of his team members and his name will be mentioned on the UIM Team Licence.

## 11. YELLOW AND RED CARDS

- 11.1. All yellow cards issued will be confirmed on a form which will be posted with the results. The driver has 60 minutes to protest to the Protest Judge. If the protest is not upheld, he can appeal. Protests and appeals must be lodged in accordance with UIM rules.

Yellow cards given in other Formulae Series (F2) will be taken into account on the yellow card listing.

- 11.2. Yellow cards can be given for the following reasons:
- up to two yellow cards at a time for dangerous driving;
  - Red card for extremely dangerous driving.

A driver who has a red card or three valid yellow cards will lose the right to take part in the following round of the World Championship (current season or following season), but his boat must participate in the race with a substitute driver. When a penalty of not racing at the next race has been satisfied, the 3 yellow cards or the red card are deleted by the application of that penalty.

- 11.3. All cards will remain valid for the four events of the Championship following the date on which the last card was delivered.

Participating in training, timed trials, and final race will be considered as having completed one event.

Any yellow card will be served the following round of the World Championship. If a red card is issued, the driver will be immediately disqualified from the event he was issued the red card.

- 11.4. An organiser/N.A. who has given one or more yellow cards to a driver must inform UIM by fax or mail within 3 days. UIM will inform the next organisers/N.A.'s. of the World Championship races about the delivery of such yellow cards. When a driver has completed 4 races without yellow cards, his previous yellow card(s) will be deleted from the listing.
- 11.5. Yellow cards issued must be mentioned in the commissioner's report which must be distributed to all members of the relevant UIM Formula commissioners panel.
- 11.6. Penalties, fines and yellow cards will be issued in accordance with the following list:

INFRINGEMENT	FINE (IN EURO).
Boat and racing gear too late in pits	420 €
Registration after specified time	420 €
Not present at drivers meeting roll call	840 €
Not respecting dress code	135 €
Not maintaining or leaving a clean paddock area	300 €
Missing compulsory functions	1000 €
Not respecting exit lane decision O.O.D./UIM Comm.	1 yel or 200 €
Not respecting entrance lane decision O.O.D./UIM Comm.	1 yel or 200 €
Radio man not at timing control	420 €

Not lining up in 20 seconds	340 €
Not in correct position on parade lap	End of the grid
Destroying first buoy	600 €
Destroying second buoy	600 €
Destroying first buoy during the race	1 lap and 600 €
Destroying second buoy during the race	disq. and 600 €
Overtaking under yellow flag	1 lap
In pit during yellow flag	last position
Not in correct position under yellow flag	1 lap
Dangerous driving	1 or 2 yellow
Extremely dangerous/dirty driving	red card
Driver refusing to be weighed separately	405 €
Not using red/yellow light system in boat	420 €
Taking outside assistance	disq
Responsible for stopping the race	disq
Taking technicians on boat (not applicable to the race winner)	340 €
Noise / silencer violation	510 €
Bringing own fuel to race venue	840 €
Not respecting instructions of UIM Comm / and or Officials	200 €
Not connecting fuel pump lanyard to life jacket	1000 €
Closed valve of airbag system :	1500 €
No closing safety belts during time trials, free practice and the race :	5000 €
Taping the deck plate during practice, time trials and race	1500 €
Not connecting roll-over switch	1500 €
Top 3 finishers not reaching podium within 15 minutes after end of the race	2000 €
No testing on the race course 7 days prior to the race for any race team. The only exception for any boat to be on the race course would be the 2 seater, or a boat for TV or promotion publicity, but not times will be taken, nor changing of propellers.	3000 €

#### Jumping the gun:

Commissioners shall notify the team of the jumping of the gun infringement within 5 laps from the start of the race and then the driver must go back to the last position immediately

Non respect of rules whilst overlapping : the radio man will be show a yellow card - if his boat is still not out of the way, the red card will be shown and his boat will be disqualified. A black flag will be given to any boat not obeying the instructions of the sports commissioner or the OOD.

The Daily Management Committee may decide to apply a "drive-through" immediate-penalty in cases that carry a 1 lap penalty. The driver will exit the race course at the exit lane and reduce speed to safely proceed to the start pontoon. The pontoon marshal will give the signal to safely re-enter the race through the entrance. This will be announced in the advance programme and/or the driver's meeting. The drive-through penalty can only be taken under Green Flag conditions. This will be communicated from the Commissioner to the driver via his radio person and a board flashing the drivers boat number. The driver must complete the drive through penalty within three green flag laps of the announcement. He must leave the course at the pit entrance buoy and enter the race course at least at the back of the field maintaining 4000 r.p.m. during the penalty lap under the green flag. Failing to comply will result in disqualification for the race.

The F1 Daily Management has the right to fine a drivers and crew (money or suspension) for any infringement of the rules or any abusive or unsportsmanlike behaviour.

To be applied to all people in the paddock :

A blue card can be given by the F1 commissioner for any offensive, unsportsman, abrasive etc, behavior during any official activity (briefing, race control during event etc.)

A second blue card will immediately remove the offender from that activity.

Following the subject activity, the Daily Management Committee will meet and determine if further disciplinary action is justified. The Daily Management Committee's decisions can be appealed to the F1 protest judge.

## 12. PROCEDURE FOR PROTEST AND APPEAL

- 12.1. A protest can be lodged in accordance with the 400 rules either by the driver or the team manager.  
Protests lodged by any driver or his/her team manager must be handled by the Protest Judge according to the rules.

The protest fee for F1 is 250 Euro.

- 12.2. An appeal must be submitted in writing (fax, mail) to the UIM office for the attention of Secretary General within the specified time limit and signed by the driver or his/her team manager.

- 12.3. The time limit for appeal submission is 48 hours, and is counted from the moment of the communication of the protest judge's decision to the interested parties.

The 24 hours of the race day do not count within the 48 hours to appeal. Address, telephone, e-mail, and fax should be clearly mentioned on the appeal so that the UIM can send any correspondence directly to the driver, with a copy to his/her N.A.

- 12.4. The driver may agree to forego an Appeal Committee meeting and for the appeal to be handled through telecommunication channel, if possible, in order to minimise the costs of the appeal.

- 12.5. For all other aspects of an appeal the provisions of Art.405 apply.

The decision shall be given within 7 days and in any case before the registration for the following race.

## 13. SAFETY

- 13.1. Following an accident, the driver must undergo a physical examination and be passed fit by the event medical staff before being permitted to continue in that racing event.

Following any accident, damaged boats must be completely rechecked and approved by the UIM Commissioner before being permitted to rejoin the event.

The certified (or recertified) minimum 6 strap/6 point mounting system must be replaced according to the manufacturers recommended replacement interval or after an accident that results in structural damage to either the cockpit or hull; or injury to the driver. The manufacturer's certificate must be available and show the date of manufacture or recertification.

- 13.2. Immersion trainings at race venues will be carried-out by Osprey at least once during the season, starting with the first event in the calendar. Drivers may alternatively have a test in UK, by arrangement. Drivers entering the series part way through, will be accepted with their own National Authorities immersion test certificate, which will be valid only up to the time of the next immersion test organised by Osprey. The immersion training will be carried out with each participant wearing their Frontal Head Restraint (FHR).

An example of the certificate and instructions of how to perform an immersion test are available at the UIM Secretariat.

- 13.3. The deformable pickle forks are mandatory according to rule 509.02.

- 13.4. Reinforced cockpits are mandatory according to rule 509.

Cockpits manufactured after January 1, 2010 shall have the aft portion closed off in a fashion to encourage the deflection of a boat colliding from a direction aft of the cockpit. To meet this objective the closed off area (the rear bulkhead) shall slope upward as shown in Figure 1. In addition the closed off area shall be rounded in the top view as shown in Figure 2.

The interior backboard behind the driver shall be provided with an opening 100 mm high and extending the full width of the inside of the cockpit. The vertical elevation of the bottom of the opening shall be at an elevation at the drivers shoulder line.

Additional horizontal bulkheads shall be provided above and below the backboard opening, extending to each side and the closed rear of the cockpit. The lower of these horizontal bulkheads shall be installed at ninety degrees to the driver's spine as shown in Figure 1. Driver's shoulder harness shall be attached to this lower bulkhead at a distance apart of 100 to 150 mm. Where seat belt fasteners penetrate this bulkhead, inserts are to be used as in 509.18.

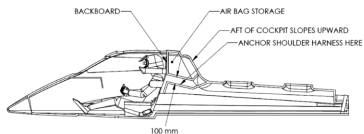


FIGURE 1

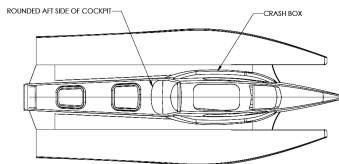


FIGURE 2

Two alternative construction methods shall be permitted for this rear bulkhead:

The bulkhead may be molded integrally with the capsule. The layup of this bulkhead shall match that of the capsule as has been registered with UIM.

The bulkhead may be bolted to the capsule in order to provide access to the space behind the driver. Older boats may also be upgraded in this manner. The layup of this bulkhead shall also match that of the capsule that as has been registered with UIM Bolting of the bulkhead to the capsule shall be accomplished as shown in Figure 3. A minimum of ten 8 mm bolts with SAE Standard flat washers shall be used to fasten the bulkhead to the capsule. The flanges through which the bulkhead is bolted shall not have a honeycomb or foam core. Each of the flanges shall have a minimum thickness of 3 mm. To prevent corrosion of the fasteners, it is recommended that carbon fiber not be included in the layup of the flanges. If carbon fiber is included it is recommended that it be electrically insulated from the fasteners. Blind fasteners may be used.

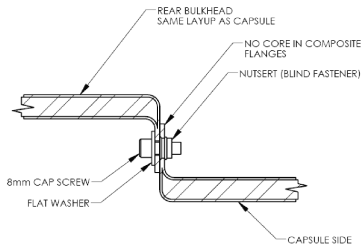


FIGURE 3

- 13.5. For existing cockpits manufactured before January 1, 2010 a third alternative construction may be used and will be mandatory starting January 1, 2011. Cockpits manufactured after January 1, 2010 may also use this third alternative construction.

The third method of construction will consist of an add on crash box located behind the existing back board. The materials and construction of this crash box will conform to the materials and lay-up of the side crash boxes as certified by UIM for the manufacturer of the boat. Existing foam flotation may be removed to accommodate this rear crash box.

This rear crash box shall extend to the inner sides of the cockpit and the top under side of the cockpit or the underside of the air bag enclosure. The crash box shall extend down to the deck line or below. Exceptions on the side may be made for fastening. Minimum thickness everywhere on this crash box shall be the same thickness as the side crash box. Shape of the back of the crash box is free as long as the minimum thickness is maintained. This rear crash box must be removable for inspection. The crash box may be fastened from the inside of the cockpit with bolts, or from behind the backboard with minimum 2,5 cm straps anchored to the seat belt mounting bar.

It is mandatory to wear a crash helmet.

All crash helmets must comply with SNELL or FIA specifications on the UIM website.

Drivers must use a Frontal Head Restraint (FHR) which satisfies SFI 38.1 or FIA 8858, has a low profile in the rear head area, and utilize quick release tether attachments to the helmet.

Helmets must be replaced every 5 (five) years from manufacture date, or after an accident and if for any reason the helmet fails to pass the technical scrutineering.

Full face helmet is recommended.

Life jackets incorporating pants, are mandatory.

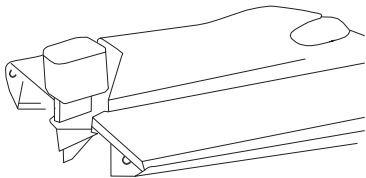
Drivers must wear a life jacket so constructed at the shoulders and the legs, that a driver can be easily pulled out of the cockpit.

"Kevlar" type ballistic material in life jackets/ driving suits is not required.

Floatation overalls are a permitted alternative to life jackets, but must incorporate extraction handholds for driver removal from the cockpit.

It is recommended that the colour of the floating overalls is orange.

- 13.6. The homologated delayed operation buoyancy airbag is mandatory. The maintenance of the airbag system is the responsibility of the team.
- 13.7. UIM reserves the right to introduce safety rules effective in a reasonable time following notice.
- 13.8. There will be an official rescue team contracted by the promoter for the entire season.  
All local services provided by the organiser will work in conjunction with the official rescue team under the overall control of the O.O.D., his substitute or the medical officer.
- 13.9. It is not permitted to take technicians on the boats (financial penalty will be applied).  
The winner can take his technicians for the victory parade lap only. A rescue boat will follow the winning team at close distance.
- 13.10. Seats are mandatory for F1 cockpits (for description see 509.08).
- 13.11. F1 cockpit boats must have UIM registered safety crash boxes installed on both sides of the safety cockpit.
- 13.12. All craft must have an isolation switch as close to the positive terminal of the battery(ies) as practicable (negative terminal if positive earth system is employed).  
The operating handle of the switch must be easily accessible on the deck or other surface of the boat on the port side between 1 to 3 meters forward of the stern.  
This switch must be marked with a red flash + and the ON/OFF positions shown.
- 13.13. Mooring eyes must be placed on the back of each sponson no more than 20 cm in from the outside of the sponson -see drawing



- 13.14 Slings and hooks to crane boats in and out of the water, are mandatory according to rule 205.12. Slings and hooks must be replaced every year.



## 14. GENERAL

- 14.1. Drivers who have not committed to participate in all races of the Formula1 World Championship, have to pay an entry fee of 670 euro for each race.

All entries must be made by the team to the UIM.

All entry forms will include the text of the eligibility conditions and the following declaration will have to be signed by all team members « understanding that as a team member / driver I am participating in an UIM Formula 1 Powerboat World Championship event which has ongoing international and sporting significance and in consideration of the acceptance of my participation therein, I agree to be filmed, televised, photographed and otherwise recorded during the World Championship under the conditions and for the purposes now or hereafter authorised by the UIM and the Formula 1 promoter.»

- 14.2. All drivers uniforms and boats must feature series sponsors logo and badges.
- 14.3. The official film crew of the Formula 1 World Championship, will be contracted by the Formula 1 promoter. All TV, film, media and commercial rights are the property of the UIM.  
The UIM contracted promoter handles the rights on behalf of the UIM.  
Any organisation wishing to film or to use existing film must contact the promoter.
- 14.4. The official Formula 1 passes are the recognised access to race events.
- 14.5. The official UIM Formula 1 logo must be prominently displayed on both sides of all participating boats.
- 14.6. The UIM flag shall be flown from the podium if other flags are flown  
Enlarged UIM Formula 1 logo has to be prominently displayed on top of the podium during prize giving or during any other public function.
- 14.7. The Formula 1 Committee with the support of Formula 1 Promoter, digitalize, using Modern Internet Technology, all information available including the mandatory by rules. The digital Logbook will be cloud-based, the access will start from UIM website, providing secure access through dedicated user credentials and all traffic will be SSL encrypted.

Any correspondence regarding the Formula 1 must be sent to the following address:

UNION INTERNATIONALE MOTONAUTIQUE STADE LOUIS II - ENTREE H  
1 AVENUE DES CASTELANS MC 98000 MONACO

E-mail: [uim@uim.sport](mailto:uim@uim.sport)



# **NATIONS CUP RULES 2022**

**Published on 22/12/21**

## 1. DEFINITION

UIM Nations Cup is an international series of Grand Prix events sanctioned by the Union Internationale Motonautique (UIM) between National Teams appointed by UIM National Authorities.

Each Grand Prix is organised by a promoter.

Up to 10 National Teams, each registered by their UIM National Authority, will be eligible to participate in UIM Nations Cup Grand Prix.

The promoter will put at the disposal of each National Team two UIM Nations Cup boats powered by a Mercury Optimax 200XS SST engine, fully equipped and ready to race, including propellers and radio system.

The UIM Nations Cup boats are fully liveried in respective national colours.

All racing equipment (boats, engines and propellers) is owned and maintained by the promoter.

Drivers participating in UIM Nations Cup are appointed by their National Authority and will be accepted by the promoter at its sole discretion.

Each National Team will consist of:

- Minimum 2 up to 4 drivers
- 1 or 2 radiomen
- 1 team manager
- 2 technicians/support crew per boat

The UIM Formulae Committee will be supervising the series and the UIM Nations Cup rules. Daily management will be performed by a committee determined between the promoter and the Formulae Committee.

### 1.1 Entries

National Teams that have registered and been accepted by the promoter to participate in UIM Nations Cup must confirm their entries by payment of driver fees and boat insurances to the designated promoter account, 60 days prior to the event.

### 1.2 Logistics

Each National Team is responsible for covering all travel and hotel expenses for all people representing the Nation.

### 1.3 Race Officials

UIM Nations Cup events are run by the Officials appointed by UIM.

## 2. RACE FORMAT

Each UIM Nations Cup event will take place over a period of three or four days in accordance with the published UIM Circuit Rules for racing, classification, protests and appeals and the specific rules for the UIM Nations Cup.

### DAY 1

14:00 - 16:00	1st Driver's Briefing with assignment of boats, engines and propellers to National Teams
---------------	--

### DAY 2

09:00 – 09:45	Drivers' Briefing (mandatory for Drivers, Team Manager and Radiomen)
10:00 – 12:00	Free Practice on Race Course
14:00 – 15:00	Free Practice on Race Course

**DAY 3**

9:00 - 9:30	Drivers' Briefing (mandatory for Drivers, Team Manager and Radiomen)
10:00 – 11:00	Free practice for Match Race
11:30 – 12:30	Time Trials for Match Race
14:30 – 16:30	UIM Nations Cup Match Race Followed by podium presentation

**DAY 4**

10:00 – 10:30	Drivers' briefing (mandatory for Drivers, Team Manager and Radiomen)
11:00 – 12:30	Free Practice and Time Trials
14:00	Lap Parade
14:15	UIM Nations Cup Grand Prix  One race of 30/45 min or Two Sprint races of 15 min Followed by podium presentation

The format of the UIM Nations Cup Grand prix will be announced in the Advance Notice and in the Race Instructions.

In case the Grand Prix is played in two Sprint Races, the minimum time between Race 1 and Race 2 must be 1 hour.

If there is a change to the race course, time for free practice will be extended.

If the time trials need to be stopped due to force majeure and less than 50% of the 45 minutes time trials were run, the results of the time trials will not be considered and the overall classification will be taken for the pole position.

In case of force majeure, this format may be amended by the UIM. Commissioner.

**3 START**

See UIM F1 World Championship Rules Art 3.

**4 STOPPED RACE**

See UIM F1 World Championship Rules Art 4.

**5 INTERRUPTED RACE**

See UIM F1 World Championship Rules Art 5.

**6 RACE COURSE**

See UIM F1 World Championship Rules Art 6.

**7 MATCH RACE**

See UIM Match Race Rules valid for all formulae races.

Are admitted to the Match Race the Drivers who get the best 16 times in the Time Trials.

The Drivers who get into Time Trials over time to 16 place, they get points from 17 to 20 place in the final match race according with the position taken during the Time Trials.

## 8 CLASSIFICATION

For the UIM Nations Cup Grand Prix, see the general UIM. F1 World Championship Art. 7.

Points will be awarded to the 20 classified drivers in accordance with the following finishing points scale:

1<sup>st</sup> 25pts ; 2<sup>nd</sup> 22pts ; 3<sup>rd</sup> 20pts ; 4<sup>th</sup> 18pts ; 5<sup>th</sup> 16pts ; 6<sup>th</sup> 15pts ; 7<sup>th</sup> 14pts ; 8<sup>th</sup> 13pts ; 9<sup>th</sup> 12pts ; 10<sup>th</sup> 11pts ; 11<sup>th</sup> 10pts ; 12<sup>th</sup> 9pts ; 13<sup>th</sup> 8pts ; 14<sup>th</sup> 7pts ; 15<sup>th</sup> 6pts ; 16<sup>th</sup> 5pts ; 17<sup>th</sup> 4pts ; 18<sup>th</sup> 3pts ; 19<sup>th</sup> 2pts ; 20<sup>th</sup> 1pt

The same point scale will be awarded to the 20 classified drivers in the Match Race in accordance with the classification on the tournament and the best times achieved in the qualifying matches.

The sum of the 3 best results out of the 4 scored within the Match Race and the Grand Prix, is counted for each competing National Team and determine the final classification by Nation.

The Nation that achieves the highest cumulative points score during the season will be the overall winner of the "UIM Nations Cup Trophy". The Trophy will be held by the winning Nation, who will deliver it to the winner of next Season during the annual UIM. Awards Gala.

## 9 TECHNICAL RULES

UIM Nations Cup is limited to the use of racing equipment that H2O Racing is making available to the National Teams. Any changes or modifications will result in disqualification.

### 9.1 BOAT

UIM Nations Cup boats are identical tunnel-hull catamarans with the following specifications:

- Total Weight in race trim : kg 455
- Length : 5.302 mm (with engines 5.945 mm)
- Width : 2.185 mm
- High : 1.320 mm
- Steering system by wire without power assistant
- Crash box : Homologated UIM n° CB10/062007
- Cockpit 3000N : Homologated UIM n° 235
- Airbag : Blazer performance: Homologated UIM n° AB06/00102
- 6-points safety belts
- 90 liters fuel tank
- Radio System

The Boats will be allocated by draw at beginning of the season.

The Teams are responsible to adapt the cockpit to the driver. No other changes or modification are allowed. A broken or damaged boat will not be replaced or substituted until the next event.

The promoter reserves the right to reallocate the boats to the teams at its sole discretion.

### 9.2 ENGINES

All UIM Nations Cup boats are powered by a Mercury Optimax 200XS SST stock engine, per homologation n° 00501C.

- Power : 200 HP
- Maximum RPM : 8.000
- Gear case SSM IV 15:17

The engines are sealed and will be allocated by draw at the beginning of the season. No changes or modifications are allowed.

After each event, the engine of the winning boat will be changed with one from another boat by draw. Any broken engine will not be replaced or substituted until the next event.

The promoter reserves the right to reallocate the engines to the Teams at its sole discretion.

### **9.3 PROPELLERS**

Each boat will be equipped with a propeller provided by H2O Racing. The propellers will be allocated by draw at the beginning of each event. No modifications or other propellers are allowed.

### **9.4 SAFETY RULES**

See UIM General Rules Art 205.

## **10. FUEL**

Fuel is supplied free of charge to all the National Teams in conformity with UIM. rule Art 508.01.

## **11. LICENCE**

Drivers must hold an international licence issued by their National Authority according with the UIM. General Rules Art. 109.

## **12. PENALTIES**

See UIM. F1 World Championship Rules Art 11 (to be revised the fines).

## **13. PROTEST AND APPEAL**

See UIM. F1 World Championship Rules Art 12.

## **14. GENERAL**

### **14.1 INSURANCE**

The Drivers must hold an International licence issued by their National Authority and a third party liability insurance as required by the Country hosting the event.

### **14.2 IMAGE**

The team member / driver participating in a UIM Nations Cup event which has ongoing international and sportive significance and in consideration of the acceptance of his/her participation in the Championship, the team member / driver accepts to be filmed, televised, photographed and otherwise recorded during the World Championship under the conditions and for the purposes now or hereafter authorised by the UIM. and the UIM Nations Cup promoter.

## **15. ADVERTISING**

The promoter is making available on the boats the following spaces for the Teams' sponsors: 2 stickers 80x30 cm, 1 sticker 30x60 and 2 stickers 105x30

Teams are responsible for producing and fixing on the boats their advert stickers.

It is the Team's responsibility to make sure that its sponsors are in compliance with the local and television transmission rules. Teams have to nominate their sponsors to the promoter. In case of conflict, Series and Event sponsors will take preference.

## 16. DIGITAL LOGBOOK

The Formulae Committee with the support of the NATIONS CUP Promoter will digitize using Modern Internet Technology, all information available including that which is mandatory by the rules. The Digital Logbook will be cloud-based, the access will start from the UIM website, providing secure access through dedicated user credentials and all traffic will be SSL encrypted.

## 17. DIGITAL MEASUREMENT CERTIFICATE

A boat is not allowed to take part in a local, National or International race without a Digital Measurement Certificate, issued by a National Authority, in English, according to the official UIM Digital model. The certificate, filed and managed with the boat's logbook, will be updated dynamically at each event and has no expiration unless:

1. Change of Ownership
2. Length and/or width change
3. The National Authority, by its rights, may insert an Alert in the Digital Logbook of any of their measured boats, to send a message to the UIM Commissioner for any justified action to be taken before a race event.

Each National Authority stipulates the cost of measurement. If no National Authority is available the UIM can issue a Measurement Certificate to confirm conformity to the rules.

The request to obtain a Measurement Certificate must be from the Boat Owner and must be accompanied by the UIM homologation file of the motor, if measurement is requested for the devices being used.



# **FORMULA 2 RULES 2022**

**PUBLISHED ON 22/12/21**



1. ORGANISATION
2. RACE FORMAT
3. START
4. STOPPED RACE
5. INTERRUPTED RACE
6. RACE COURSE
7. CLASSIFICATION
8. EQUIPMENT
9. FUELS
10. SUPERLICENCES
11. YELLOW CARDS
12. PENALTIES
13. PROCEDURE FOR PROTEST AND APPEAL
14. SAFETY
15. GENERAL
16. INSURANCE
17. FINANCIAL CONDITIONS

## INTERPRETATION OF THE RULES - 200.02

In all cases unforeseen by the international rules, the international jury is to adjudicate bearing in mind the spirit of the rules.

In case of conflicting rules, those rules concerning the Championship as published in the blue pages of the Circuit Rules Handbook are to prevail.

### 1. ORGANISATION

- 1.1. The rights of organisation of F2 races and championships is owned and ruled by the UIM which has granted the management of the competition to the Council. The UIM may appoint a Race Director who reports to the OOD. He assists the OOD in all duties and is entitled to impose penalties.
- 1.2. The Council may update the rules whenever necessary.
- 1.3. The F2 daily management Committee is responsible for the championship daily management. This Committee is composed of the F2 Driver Rep (1 Vote), Team Rep (1 vote), UIM Technical Commissioner appointed for the event (1 Vote) and the UIM Race Director (1 Vote, or casting vote).
- 1.4. The F2 World Championship Events are governed by the UIM international rules for circuit racing, as published in the white and blue pages of the Circuit Rulebook and by the instructions issued by the UIM Events.
- 1.5. Two UIM Commissioners (1 Commissioner - 1 Technical Commissioner) plus 1 UIM Pontoon Marshall and 1 local Technical Assistant from the national Authority will be appointed for each round of the F2 World Championship series which will be held over a minimum of three rounds and for the F2 European Championship which will be held in one round. The UIM Commissioner and the Technical Commissioner shall send their report within 10 days after the race to the UIM office.
  - 1.5.1 A Jury Committee is responsible to make decisions in case of protest that consist of the following members: JURY CHAIRMAN appointed by the Local Organizer, UIM Sport Commissioner and F2 Team Representative. (see also article 402.01 of General Rules)
- 1.6. Any additional rule to these specific rules must be justified by national legal requirements and notified in the advance programme
- 1.7. A Continental Championship can be allocated by the decision of Formulae Committee and it will consist in one round.

- 1.8 The Official Championship Timing Team appointed by the UIM and operating at the cost of the Local Organizer must be used at all World Championship and Continental Championship events.
- 1.9 The Rescue Team to be used at all World Championship and Continental Championship events shall be appointed by the UIM. There must be a minimum of two drop-front rescue boats along the circuit. The Local Organizer of each UIM F2 World and Continental Championship round must provide a two seater aqua bike with driver, to service as a 3rd and fast response Rescue unit. A skilled diver is to be provided by the Official Rescue Team for the operation.
- 1.10 All the National Authorities who intend to organize a Formula 2 World or Continental Championship event, have to send their request to the UIM Secretariat with date and venue for their event before the 10<sup>th</sup> September of the previous year.
- 1.11 The Digital Log Book shall be used during the season.
- 1.12 FORMULA 2 TEAM ASSOCIATION (F2TA) is an Association composed of Formula 2 Teams. It cooperates closely with the UIM Events in the organization of the Championship to serve the needs of all Teams involved in the F2 Championships.

## 2. RACE FORMAT

- 2.1. Each F2 race counting towards the Drivers World Championship will include four separate parts to take place over a period of two or three consecutive days in accordance with the full UIM Circuit rules for racing, classification, protests and appeal and by the specific rules listed below.

Each World Championship round shall be organized on a course with a water registration allowing at least 18 boats to start.

- 2.2. Each Organizer must guarantee to have the permission released by Local Authority for running on the water under fair conditions. In case of force majeure the race may take place in one day.
- 2.3. If, through Force Majeur, less than 25% of the programmed total timed trial period is run, the grid positions will be established using the current championship order.
- 2.4. The programme for the event must include:

2.4.1. Free practice (minimum 1 x 90 minutes);

2.4.2. Qualifying

- Q1: All boats may run laps at any time during the first 20 minutes of the hour. Timing of the boats will start after the time that the first boat has completed 3 laps. At the end of the first 20 minutes, only the fastest 15 boats will remain in the water, the excluded boats will fill the final grid positions.

- Q2: After a minimum seven minute break, the times will be reset to zero and the 15 remaining boats will then run a further 15 minute session. Timing of the boats will start after the time that the first boat has completed 3 laps. Again the boats may complete as many laps as they want during the 15 minute session. At the end of Q2, the 9 slowest boats will drop out and fill position 7- 15 on the start grid.

- Q3 = The Top 6 boats will run together for 15 minutes, no limit of laps per boat.

Q1, Q2 and Q3 : RED and YELLOW FLAG

If a RED FLAG is required during Q1 and/or Q2 and/or Q3, the time is immediately stopped and all boats must return to the pontoon. When the race course is again ready, the UIM Sports Commissioner shows the green FLAG and the time will start again.

If a YELLOW FLAG is required in Q1 and/or Q2 and/or Q3, all boats may stay in on the race course, respect the area with the YELLOW FLAG and must reduce speed. No timing will be taken during the YELLOW flag period, and the time required to clear the course is added on to the remaining time for Q1 and/or Q2 and/or Q3.

If there are 25 boats or more enrolled at the event, the qualifying will be as follows:

**FREE PRACTICE**

The drivers will be split into two groups = Group A and Group B (The groups will be chosen by alternate race number from the entry list). 90 minutes practice for each group.

**QUALIFYING**

**Q1** = The drivers will be put into three groups: Group A – Group B – Group C  
(9 + 8 + 8 = 25)

So the groups will be as follows:

GROUP A – 9 drivers

Position = 1-4-7-10-13-16-19-22-25

GROUP B – 8 drivers

Position = 2-5-8-11-14-17-20-23

GROUP C – 8 drivers

Position = 3-6-9-12-15-18-21-24

20 minutes of each group.

Only if two boats of the same Team come into the same group, the UIM Commissioner can change the group for another boat.

**Q2** = The top five boats of each group A-B-C go into the Q2 session

**Q3** = The Top 6 boats will run together for 15 minutes, no limit of laps per boat.

If for any reason qualifying cannot be completed on the Saturday or take place at all, one of the following alternatives will be used:

- Use the results from Q1 or jointly from Q1 and Q2.
- Have 1 hour qualifying session for all boats with unlimited number of timed laps.
- Use the current World Championship positions, or if the first race of the season, the World Championship positions of the previous season.

**NO Q3 session to take place on the race day of the event**

If a driver is deemed to have stopped unnecessarily on the circuit or impeded another driver during qualifying, his times may be cancelled.

***No additional nor removing weight can be added / removed after the green flag shows for start for qualification.***

No refueling allowed during the full qualifying session.

***There must be enough of fuel left in fuel tank so it can be taken one A sample and B sample (if needed) of fuel for fuel check when qualification is over.***

- Any change of boat or internal parts of the engine, after the time trial begins will entail the driver starting in last position on the start pontoon. Any engine changed after the time trials will be sealed by the UIM Technical Commissioner and will be checked for legality and the driver will start in last position on the start pontoon.
- If more than one boat is relegated to the end of the start pontoon, their position will be determined by qualification time i.e.: slowest qualification time, last on the grid, 2nd slowest 2nd to last on the grid etc.
- There should be a minimum of one hour between the practice and the qualifying session.
- For free practice. In which case the Commissioner will reserve the right at any time to prevent boats leaving the jetty to participate in timed trials depending on the amount of traffic already on the circuit. Boats may indicate their readiness to start practice runs by **staying** in a designated waiting area only, and their radio person will be informed when the driver can join the circuit. Boats wishing to make a practice run cannot wait in any area other than the designated one.

For Q1 two groups A and B shall be drawn by ballot after free practice. By combining the times from group A and B the 15 best times / drivers go through to Q2 and then by 2.4.2 Qualifying Q2 and Q3.

For those who do not qualify (2.4.2 Qualifying Q2 and Q3), the possibility exists of a qualifying race over 15 minutes, it must be done at least two hours before the F2 main race on Sunday.

2.4.6. The F2 race [approx. 35 minutes duration plus 10% (up to five) of the missing laps, but with a limit of 90 minutes including any re-starts]

2.4.7 A typical programme would be:

#### DAY 1

Pit area opens at 08.00

Registration

Scrutineering

Permanent meeting of F2 Team Association meeting

#### DAY 2

Compulsory drivers and radio persons roll-call and briefing, penalty if not present (12.2 – 12.6) Free practice period [90 minutes].

Qualifying as per 2.4.2 if not using the large entry Q system Match Races, to be covered by separate instructions.

#### DAY 3

Compulsory drivers and radio persons roll-call and meeting. Penalty if not present (12.2 – 12.6)

All drivers are requested to wear their racing vest and have their helmets for the group picture mandatory after mentioned above drivers meeting.

Warm-up [45 mins].

Qualifying race.

Presentation parade lap.

Race.

Prize giving to take place within 20 minutes after the conclusion of the race. Compulsory participation of top three finishers in prize giving ceremony. Penalty if not present (12.2.1)

2.4.7.1 MATCH RACE and SPEED TRIAL

F2 rules MATCH RACE = Detailed information are given on art. 307.05 (white pages)

SPEED TRIALS = The Local Organizer who want run SPEED TRIAL has to provide a certified radar gun for taking correct speed of each participating driver.

It is not allowed to use different propellers during the session of Speed Trial and the Match Race.

- 2.5. Detailed information about practice, timed trials, Match Races, and number of boats allowed on the circuit must be given in the advance programme
- 2.6. If a race is shortened due to force majeure, it is at the discretion of the O.O.D. and the UIM Race Director to alter the time table and if necessary the course layout accordingly. In the event of no qualifying times being achieved, the grid will be drawn-up in accordance with the current championship positions.
- 2.7. No entry shall be considered official until the boat has passed the scrutineering and documents controls
- 2.8. Calculating the number of laps is as follows : Add up the final qualifying times for the boats in positions 5 to 14. Divide by 10 to get an average time. Divide the average time into the time of the race in seconds. This will give the number of laps. You may round up or down to nearest 5.

### 3. START

- 3.1. The fastest time recorded for each boat by the official timekeepers, during official timed trials, shall determine the starting positions of boats for the race or the qualifying heats if used.
- 3.2. The start shall be a dead engine jetty start as described in rule 307: Dead engine jetty start.
- 3.3. A course boat will be stationed at a convenient point for the last part of the parade lap, and will show a green flag; at which point the driver can use full revs to clear his engine prior to moving directly into his grid position on the start jetty.
- 3.4. Boats should be drawn up stern first with dead engine, to a jetty, floating pontoon or beach, exception for four stroke engines with friction clutches may be started at the one minute count-down and run a maximum of 1800 RPMs for the start.

Boats which do not line up with the boat next to them upon request of the race Director or Pontoon Marshal will be fined (12.7).

The start must be with the current. The distance between the starting line and the first turning buoy must be at least 300 metres.

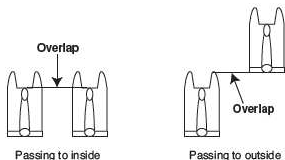
- 3.5. When the pontoon marshal is satisfied that all drivers are ready to start, with engines stopped, he will raise a green flag. The O.O.D. or UIM Race Director will initiate the start procedure. He instructs the starter to raise a 30 seconds board (min. 80 x 80 cm, figures 60 x 10 cm), or when the remote operated start lights are used, the 30 sign will be illuminated.
- 3.6. After 30 seconds this board will be lowered the blue flashing lights switched off, or the 30 sign switched off, the red lights will be switched on. After 5-12 seconds the red lights are switched off, this is the signal to start.
- 3.7. These drivers rotating their engines (even with ignition switched off) prior to the red lights going off lose one lap.
- 3.8. This lap will be deducted at the end of the race.
- 3.9. The starter may decide if he judges it necessary, to cancel the start by showing the red flag and recommence the starting procedure.
- 3.10. The length of the start jetty must be equal to 4.5 metres multiplied by the maximum number of boats permitted to race, or a minimum of 100 meters, whichever is the longer. The jetty must be a minimum of 2.5 m wide, with the proper and safe stability. Example: 24 boats x 4.5 meters = 108 meters.
- 3.11. All start pontoons must be sufficiently angled (minimum 50 degrees) such that the pole position has a significant advantage towards the first turn buoy, compared with the last positions on the starting grid. The plan of the circuit (including the position of the start pontoon) must be sent to the commissioner 60 days in advance to get his approval.
- 3.12. Any boat not starting must be returned to shore by the driver's own efforts. Any crew member swimming out to a boat will cause his entry to be disqualified.
- 3.13. Drivers failing to start will wait at the dock until signalled by the pontoon marshal to fall in behind the field.
- 3.14. Before the start of the first race, each driver shall complete a lap of the course immediately after his name has been announced, so that he may be introduced to the public.

## RULES OF THE ROAD

- 3.15 An overlap may only be established when two boats are on the same course or approximately on the same course and the cockpit of the overtaking boat, if passing on the inside is level with the cockpit of the overtaken boat.

When overtaking from the outside, an overlap is established when the overtaking boat has passed the overtaken boat sufficiently to alter course without contact.

When trying to overtake a boat on the inside the driver must anticipate the possible direction of the boat it is trying to overtake and must take all necessary action to avoid a collision (see drawing)



## 4. STOPPED RACE

- 4.1 In the event that a race is completely stopped rule 311 will apply.
- 4.2 Upon showing the red flag, drivers must return slowly under their own power to the start pontoon [or other position on the circuit notified by the UIM Commissioner during drivers' briefing].
- 4.3 Drivers receiving outside assistance at any point during the race (whether the race has been stopped for an incident or not) will be disqualified.
- 4.4 Boats that have broken down and received outside assistance by being pulled to the infield, or off the race course, will be towed to the trailer or the starting dock only during a "race stop" condition and if pick-up boats are available.
- 4.5 Repairs are allowed at any time during the race, with the exception that replacement of the crankcase and the cylinder block is prohibited. Repairs are not allowed on the race course using outside assistance.
- 4.6 Only if a boat reaches the pontoon on its own power, repairs can be carried-out either while the boat is completely in the water or on its trailer, at the sole discretion of the Pontoon Marshal. Further instructions for the repair areas may be given at drivers briefing.
- 4.7 No repairs are allowed on the start pontoon during the line-up and start or re-start preparations.
- 4.8 Drivers may carry-out their own repairs on their boats in accordance with the rules. The driver's two nominated pontoon mechanics and the official crane driver do not count as outside assistance.
- 4.9 In the event of a restart a boat being repaired must be ready to take its position on the grid as directed by the Pontoon Marshal. If the boat is not ready to take its position, it must start at the end of the pontoon.

- 4.10 Hulls and motors must be sealed after scrutineering and before practice. In races with several restarts, substitution of hull or motors between the restarts or during the race is prohibited.
- 4.11 To qualify for points, a stopped race must be restarted if 70% of the total distance specified for the race has not been covered at the time the race is stopped.
- 4.12 The number of laps completed + 1 lap per restart will be deducted from the restarted race.
- 4.13 Should there be a restart, starting positions will be determined by the order of the end of the lap prior to the race being stopped.
- 4.14 All boats which are ready to race, may start in a restarted race.

## 5. INTERRUPTED RACE – YELLOW FLAG

- 5.1. The UIM Race Director may interrupt the race for any reasons of safety or emergency services access, and in which case the rescue boats and race control will show yellow flags.
- 5.2. At this signal all drivers must immediately slow down and not overtake. Any overtaking after the yellow signal has been given, will be penalised by 1 lap. The leading boat, will act as pace boat, and run at slow speed.
- 5.3. When the race course is clear, only the yellow flag at race control will be continued to be shown.
- 5.4. All boats maintain their position at slow speed (approx. 4000 rpm) until race control raises the green flag. It is the responsibility of the team managers to ensure that their boat(s) are in the correct position at the restart. If a boat, in any position on the water is judged to be speeding or causing a hazard under the yellow flag, they may receive a drive through or 1 lap penalty.
- 5.5. When a rolling re-start is used, the UIM Commissioner can restart the race by showing a green flag at any point on the race course. The first 10 boats must be in their correct positions before the race can be restarted. The position of the boats for the rolling restart will be that of their classification order on the lap before the yellow signal was given.
- 5.6. Boats which do not restart in their correct position, will be given a one lap penalty..
- 5.7. During the yellow signal situation, a boat may leave the race course but must re-join the race behind the boat running in last position.
- 5.8. In races run with the pace boat system in operation, a yellow flag will be used by race control and the rescue boats to indicate a hazard when displayed stationary, and extreme caution to be exercised by drivers when waved vigorously. No overtaking permitted during yellow flag status.
- 5.9. If the total number of laps are completed and the race is under a yellow flag situation. The UIM Commissioner will inform the teams that an extra 5 laps will be added to enable the race to be completed with a chequered flag finish.

## 6. RACE COURSE

- 6.1. Course and safety rules shall be those of the UIM applicable in this season unless otherwise decided by the Daily Management.
- 6.2. The length of straight between any two turning buoys is to be a maximum of 850 metres. The boundaries of the water on which practice and racing are allowed to take place must be defined in the advance programme.
- 6.3. In cases of force Majeure, any changes to the course must be agreed by the Daily Management Committee members present at the event and the new course presented to the drivers. If the course is changed from its original specifications then free practice may be offered to the drivers if the time schedule permits.
- 6.4. The pit area should be sufficiently large to prevent boats being craned into the water over other boats.
- 6.5. There must be a minimum of 2 cranes.
- 6.6. The Local Organizer has to provide a specific area for timing/race control/ Radio persons (9 x 3 meters) with at least three TV set, tables and chairs. Table with three chairs and a power connection for TIMING (3 x 3); table  
With a TV screen for RACE CONTROL (3 x 3); tables and chairs with 2 TV set minimum for RADIO PERSONS (3 x 3)

- 6.7 For the new venue it is mandatory an inspection on the spot, two months in Advance prior the publication of advance program of the relevant race, to be done by two persons from Formulae Committee appointed by Chairman of Formulae Committee; the costs of relevant travel and stay are in charge of Local Organizer.

## 7. CLASSIFICATION

- 7.1. The boat placed first will be the one having covered the scheduled distance in the shortest time.
- 7.2. All boats will be classified by taking into account the number of complete laps they have covered and for those which have completed the same number of laps, the order in which they crossed the finish line.
- 7.3. The number of laps completed during the eventual restarts will be taken in account for the classification.
- 7.4. The points will be awarded to the first 10 classified drivers crossing the finish line under their own power, on the condition that they have completed at least 70 % of the numbers of laps covered by the winner (rounded down to the nearest whole number of laps). Boats having done 90% or more laps but do not cross the finishing line after the winner has crossed will be classified after those boats that have done the same number of laps but that also cross the finishing line after the winner.
- 7.5. The leading boat must have completed 70 % of the number of laps counting for the race.
- 7.5.1. If the race cannot be restarted due to "force majeure" then the points will be awarded in accordance to the following scale: 70% or more of the total race completed full points
- 7.5.2. less than 70% half points
- 7.5.3. less than 50% no points
- 7.6. The first six classified boats are to be weighed when coming out of the water. The weighing of the boats can not be protested. The scales will be available before the meeting commences.
- 7.7. Points will be awarded to the first 10 classified drivers in accordance with the following finishing points scale:
- |         |    |        |
|---------|----|--------|
| First   | 20 | points |
| Second  | 15 | points |
| Third   | 12 | points |
| Fourth  | 9  | points |
| Fifth   | 7  | points |
| Sixth   | 5  | points |
| Seventh | 4  | points |
| Eight   | 3  | points |
| Ninth   | 2  | points |
| Tenth   | 1  | point  |
- 7.8. The overall classification for the F2 Drivers' World Championship shall be established by the addition of all points obtained by each driver in each of the races counting towards the championship.
- 7.9. In the case of a tie, the number of first places in these races shall be considered, then the second places, etc... When the total points are the same and all listed Tie Breakers have been exhausted, the Driver with the most pole positions will be declared the Winner. This procedure will be carried out to 2nd position on the starting dock and further if needed.



7.10. Immediately after the race:

- The winner may complete a lap of honour;
- Top 3 finishers must have priority at the pontoon to be able to reach the podium within 15 minutes. Penalty if not present (12.2.1).
- Presentation of trophies to the first 3 drivers on the official podium. This presentation is only based on a provisional classification, and is subject to confirmation after scrutineering and consideration of any protests or appeals.

7.12 At the last race of the series UIM will provide 3 medals (gold, silver, bronze) to be given to the first three in the overall classification of the World Championship.

7.13. These medals do not replace the normal prizes (art. 108.01 and 321).

## 8. EQUIPMENT

### 8.0. ENGINE

The only engines allowed in Formula 2 racing are the Mercury SST200 (200XS) 2.5L two-stroke and the Mercury Racing 200 APX 3.4L four-stroke.

Clarification: The UIM Homologation of the Mercury Racing 200 APX 3.4L four-stroke engine not having been issued before the first Round of the 2021 UIM F2 World Championship Round, this engine shall be authorized to be used in UIM titled events as from the 2022 powerboat racing season onwards.

For seasons 2022 and 2023, it is intended to hold two UIM F2 World Championships in parallel, one including the boats equipped with the SST200 engine, and one including the boats equipped with the 200 APX engine. Boats equipped with one or the other engine shall race jointly, and the formal recognition of said UIM F2 World Championship titles is subject to a minimum of five boats participating with one or the other engine. Should this minimum requirement of five F2 boats equipped with either one of the two engines not be met, then only one UIM F2 World Championship title shall be awarded.

### 8.1 HULL

- 8.1.1. Hull must be a catamaran type, based on twin hulls, but may be of completely free hydrodynamic and aerodynamic design.
- 8.1.2. Must conform to the general UIM rules 501; 503; 504; 505; 508; 509; 542.05 and these F2 rules.
- 8.1.3. Boats configured to work on the hydrofoil principal will not be eligible.
- 8.1.4. The minimum hull length is 4m80.
- 8.1.5. The minimum weight of the boat and driver as raced is 550 kg.
- 8.1.6. Measured in accordance with rule 542.12.
- 8.1.7. The front 305 mm. (12 inch) of the cockpit and pickles should not be made of a material which would not allow controlled deformation to reduce G forces on frontal impact (mandatory).
- 8.1.8. Each wing mirror must have minimum size of 60 sq. cm and be bolted on 2 points to assure proper mounting.  
 Within one team, two identical boats must have different colors of mirrors bodies as follows: Odd number: yellow fluorescent colored mirror bodies.  
 Even number: orange fluorescent colored mirror bodies. Third boat of the team: black colored mirror bodies.

8.1.9. Radios in boats are mandatory and a full radio check of each boat will be part of technical scrutineering in order to guarantee that all radios are working. The radio person must be present at race control whenever his boat is on the course. In order to guarantee clear communication between the Team Managers and the UIM Commissioner, all Team Managers must speak English.

8.1.10. The homologated delayed operation buoyancy airbag is mandatory.

- 8.1.11 Hull, sponsons, and powerhead replacements and other parts are allowed after scrutineering, up until the end of timed trials, but any changes to be made must be immediately notified to the UIM technical Commissioner for re-scrutineering and sealing for technical inspection of units removed.
- 8.1.12 Any replacement of boat or sponsons after qualifying time trials will result in all previous times achieved being cancelled, and the replacement boat or sponsons will be considered as a new entry, requiring full scrutineering. If no timed practice opportunity remains, the boat will start from the end of the grid.
- 8.1.13 PARC FERME

## 8.2 SST.200 ENGINE MODEL

The top three classified boats will be weighed with scales after time trials and the race. The weighing of the boats cannot be protested. The scales will be available before the meeting commences.

The top three finishers of the timed trials and race must immediately take their boats to the parc ferme/ UIM tent, without stopping on the way and without touching, replacing or modifying anything.

After the shoot out and the race, the drivers qualified in 4th-5th-6th positions are to wait in the water or at designated area until the top three finishers have been approved and the UIM Commissioners dismiss them.

Upon request of the UIM Commissioner, drivers must allow to be weighed separately. Not complying will bring immediate disqualification.

### 8.2 SST.200 ENGINE MODEL

- 8.2.1 The SST.200 engine is the only engine admitted in F2.
- 8.2.2 The SST.200 engine may not be modified in any manner other than the cylinder block, which be modified according to the measurements in the homologation file, file number 00501. When ports in cylinders are adjusted to the dimensions specified in the homologation sheet, material may only be removed in the specified opening to a depth of 10 mm, to match the shape of the original adjacent connecting passage (channel) outside the adjusted port opening.
- 8.2.3 Exchange or replacement of the engines PCM (electronic unit) may be demanded by the O.O.D./scrutineer/UIM commissioner at any time during a race event.
- 8.2.4 There will be at least 8 ECU BOXES and 8 DATA RECORDERS, property of the UIM to be allocated before the first free practice session on the Day 2. These will be allocated as follows:
- 3 ECU BOXES and DATA RECORDERS will be allocated to the first three drivers in the World Championship classification of that season. If it is the first race of the season, allocation is determined from the final classification of the previous season.
  - At least 3 ECU BOXES and DATA RECORDERS will be allocated to any other driver at the discretion of the UIM Technical Commissioner.
  - At least 2 ECU BOXES and DATA RECORDERS will be kept by the Technical Commissioner as spares in the event of a failure of another box.
- The boxes will be distributed by the Technical Commissioner at the crane area before the boat enters the water. It is the Teams responsibility to return the UIM. ECU and DATA RECORDER to the Technical Commissioner immediately before the boat returns to its trailer from the water.
- Failure to return the ECU BOX and DATA RECORDER at the correct time will result in a fine of 500€.
- At no time will any computer or diagnostic device be connected to the ECU and DATA RECORDER, the engine unit, engine or boat wiring harness or the boat. Fine, 1000€ for failing to adhere to this rule.
- The ECU BOXES and DATA RECORDER supplied will be used in all practice, qualifying sessions and races during that event. In case of the failure of a UIM. ECU an alternative unit will be supplied if available. If none is available the Team will be allowed to use their own ECU, but this will have to be handed to the UIM. Technical Commissioner directly after the race. This may be inspected and tested for conformity to the standard specification.

- 8.2.5 1. Only original standard voltage (12 Volt) is admitted for the start of the SST 200 Engine (in respect of the rule)
2. For SST 200 Engine, only original standard reed valve from engine manufacturer is allowed (in respect of the rule)
3. The Pin Plug connection wire and cover of the ECU (Electronic control units) of the SST 200 Engine is an integral part of the SST 200 Engine; only original standard from manufacturer is allowed.

### 8.3. 200 APX ENGINE MODEL

#### 1. Engine Hardware

- 1.1. The required four-stroke engine for Formula 2 is the Mercury Racing 200 APX engine, homologation number to be published on the UIM website.
- 1.2. All engine hardware must be stock, as delivered by Mercury Racing.
- 1.2.1. All hardware must be as per the official homologation document.
- 1.3. Modification and/or relocation of factory engine sensors is prohibited.
- 1.4. All engines will be equipped with tamper-proof seals at the Mercury Racing factory. If an antitamper seal is removed during post-race engine inspection, a new seal must be applied by a UIM official and the log book updated with the new seal serial number.
- 1.5. Specific components that will be sealed will be listed in the engine homologation.
- 1.6. Components provided with the engine but mounted within the boat (i.e. fuel supply module) cannot be modified.
- 1.7. No additional connections or ducting between the engine cowling and throttle is allowed.
- 1.8. The cowling must be as supplied by Mercury Racing. Additional graphics and/or alternate colors are allowable on areas specified in the engine homologation file only.

#### 2. Propulsion Control Modules (PCMs)

- 2.1. PCMs for use at a competition event will be held by the competitors. The serial numbers of each PCM and which boat they have been designated for shall be recorded.
- 2.2. At any time, a UIM official may collect a competition PCM for the purpose of checking the calibration for modification.

#### 3. Controller Area Network (CAN) Data Logging

- 3.1. Mercury Racing will provide a CAN interface for the purpose of logging ECU data to verify correct and unaltered operation of the engine during competition. The logger may be combined with the existing logger(s) used by the team.
- 3.1.1. Teams shall provide at least one available port on a SmartCraft junction box for use of the logger, and it must be readily accessible.
- 3.1.2. Teams shall provide a specified data logger to interface with Mercury's provided CAN interface module.
- 3.1.3. The data logger will log PCM sensor data and other channels as defined in the homologation document.
- 3.2. Any devices attached to the Mercury SmartCraft bus shall be for measurement purposes only, such as data loggers and boat displays. Any attached devices are subject to inspection by sanctioning body officials. Purposeful modification of SmartCraft signals is prohibited.

#### 4. Post-race inspection

- 4.1. Top finishers from each race are subject to a post-race inspection per UIM guidelines. Any of the following areas may be checked:
- 4.1.1. Engine electrical harness shall be visually inspected for modifications or repairs.
- 4.1.1.1. No harness modifications allowed
- 4.1.1.2. Any repairs from incidental damage must be tracked in official log book(s) and approved by sanctioning body officials.

4.1.1.3. Repairs must be inspected and approved prior to a competition event.

4.1.1.4. Camshaft Inspection per homologation specs – note, this requires removal of a tamper proof seal. After inspection, a new seal must be installed by a UIM official and the serial number recorded in the log book.

4.1.2. Visually inspect all hardware seals for tampering and serialization

## 9. FUEL

9.1. General fuel rules in 508 will apply.

9.2. Fuel will be supplied by the organiser in conformity with rule 508.01.

## 10. SUPERLICENCES

10.1. The nationality of a driver is the nationality of the N.A. which issued the international racing licence to the driver. Medical and immersion tests can be done in other countries if the issuing N.A. agrees. The flag is the one of the issuing N.A. of the international licence as above. The request for the UIM Superlicence must come from the N.A. which issues the international racing licence.

10.2. Drivers must hold a UIM super licence before entry will be accepted.

A driver who exceeds 50 years of age in the season for which he is applying for a superlicence, must produce the medical certificate including all detailed examinations which will be submitted to a doctor approved by the UIM

10.3. Any new driver must be vetted in practice by the UIM Race Director and the drivers delegate to the UIM.

10.4. The super licence is required for F2 together with the NA international Licence. No other membership is required.

10.5. To obtain a superlicence for the first time, a driver must have participated in the last 2 years in 6 circuit races (classified) using a catamaran type hull (750 cc minimum) or a hydrocat min 500 cc. Definition of a race during a race weekend: even if several heats take place, the race weekend with all heats or races counts as one race only. The National Authorities are fully liable for the sports c.v. that they submit for their drivers. The full race results of each race must be supplied since the drivers must have done at least 6 races with 70 % of the total distance of each race event.

10.6. The superlicence is provisional for the first 6 races and can be withdrawn at any time during the first 6 races by a committee composed by the UIM Race Director, the O.O.D and the Drivers representative. F2 Superlicence will remain as PROVISIONAL status for the first six (6) races. If the drivers cause an accident then the provisional status will be extended for one more race, with a maximum of two accidents. After causing two accidents between two boats the provisional Superlicence will be withdrawn for the remainder of the current racing season. When a super licence is withdrawn, next application can only take place for the next season.

***If a driver apply again for a superlicence after at least three years absence from F2 superlicence, the superlicence is provisional for the first 4 races and can be withdrawn at any time during the first 4 races by a committee composed by the UIM Race Director, the O.O.D and the Drivers representative. The F2 Superlicence will remain as PROVISIONAL status for the first four (4) races.***

***If the driver cause an accident, then the provisional status will be extended for one more race, with a maximum of two accidents. After causing two accidents between two boats the provisional Superlicence will be withdrawn for the remainder of the current racing season. When a superlicence is withdrawn, the next application can only take place for the next season.***

An anthropometric check of data reported in the Superlicence application may be carried out at any event during the relevant season by a UIM appointed Medical. In case the Driver's data would not be anymore within the mandatory parameters, the Driver shall be immediately disqualified from the Event and his/her the Superlicence shall remain suspended until a new Superlicence is obtained.

10.7. The application for a super licence must be made by the National Authority of the driver and lodged with the UIM 4 weeks before the first event the driver wants to participate in. The superlicence fee of 300 Euro will be doubled for applications received beyond the 4 weeks deadline.

No application will be taken in consideration within one week from the following event.

10.8. The application must be accompanied by:

- The sports career of the driver, mentioning the results obtained in the qualifying events;
- UIM medical documents, as per appendix to these rules, giving the information required by the UIM rules 109.09/ 109.10 / 109.11.

General Recommendation for F2 superlicence holders concerning physical fitness

- Cardiovascular training (endurance training) as jogging, cycling, rowing etc. twice a week - minimum 20 minutes without any interruption. Any sports activity which has "stand still" during the activity such as soccer, tennis or any ball sport is not suitable for the endurance training, but recommended as additional training;
- Training to build up muscles for neck and back at least twice a week;
- The immersion certificate (ref 205.05);
- A photo
- The fees will be fixed by the UIM Council and paid to the UIM Secretariat. Superlicence fee fixed to 300 euro. For late application, the superlicence fee has been fixed to 600 euro and must be paid to the UIM Secretariat;
- Medical expertise fee for drivers over 50 years in the season : 200 euro;
- The digital version of the rulebook is available on the UIM website.

10.9. The National Authorities are responsible for the information given.

10.10. The application will be examined by UIM Office and the appointed medical expert.

10.11. The super licence is valid for 1 year (from January 1st or from the date of issue to December 31st).

10.12. For renewal of the super licences, the National Authorities must, before the end of December, send the UIM a list of the drivers for whom a renewal for the following year is required.

## 11. YELLOW / RED : BLUE CARDS

***UIM Rule 406.05 applies.***

## 12. PENALTIES

12.1. Penalties will be issued to drivers in accordance with other UIM rules and/or with the following list:

<b>INFRINGEMENT</b>	<b>FINE IN Euros</b>
12.2. Not present at drivers meeting roll call	200
12.2.1 Not present at prize giving	1000
12.3. Not under crane when called forward	150
12.4. Not respecting exit lane	100
12.5. Not respecting entrance lane	100
12.6. Radio person not at timing control and/or not at drivers meeting	200
12.7. Not lining up within 20 seconds on jetty	150
12.8. Not in correct position on parade lap	100
12.9. Dislodging and/or destroying each turn buoy (free Practice and time trials)	200
12.9a. Destroying 1 <sup>st</sup> buoy (race only)	1 lap and 200
12.9b. Destroying 2 <sup>nd</sup> buoy (race only)	DSQ and 200
12.9c. Dislodging 1 <sup>st</sup> buoy (race only)	1 lap and 200
12.9d. Dislodging 2 <sup>nd</sup> buoy (race only)	DSQ and 200
12.10. Overtaking under yellow flag	1 lap
12.11. In visiting pit during yellow flag	last position
12.12. Not in correct position under yellow flag/re-start	1 lap
12.13. Taking technicians on boat on the course (excl. the race winner)	200
12.14. Bringing own racing fuel to race venue	300
12.15. Not respecting instructions of UIM Comm / and or Officials	DSQ, or 1 lap or 200
12.16. Non operative airbag system due to closed valve of air bottle, no connecting of roll over switch, taping or sealing of the deck plate system	1500
12.17a Any part of the Airbag system activates during time trials or free practice	Black flag
12.17b Any part of the Airbag system activates during a race	Black flag
and DSQ Not closing safety belts during time trials, free practice and the race	5000
Not connecting fuel pump lanyard to life jacket	1000

## 13. PROCEDURE FOR PROTEST AND APPEAL

- 13.1. A protest can be lodged in accordance with the 400 jurisdiction rules either by the driver or the team manager. Appeals will be handled in accordance with Art. 405.
- 13.2. The time limit to appeal is counted from the moment of the communication of the Jury decision to the interested parties and it is 48 hours.
- 13.3. The 24 hours of the race day do not count within the 48 hours to appeal. Address, telephone and fax should be clearly mentioned on the appeal so that the UIM can send any correspondence directly to the driver with copy to his/her N.A.
- 13.4. The driver may agree to forego the UIM International Court of Appeal meeting and for the appeal to be handled through telecommunication channels, if possible - in order to minimize the costs of the appeal.

## 14. SAFETY

- 14.1. Drivers must wear a floatation vest incorporating pants, and so constructed at the shoulders and the legs that a driver can be easily pulled of the cockpit. Floatation overalls (orange colour is recommended) are a permitted alternative to life jackets, but must incorporate extraction handholds for driver removal from cockpit.
- 14.2. The homologated delayed operation buoyancy airbag is mandatory. The maintenance of the airbag system is the responsibility of the team.
- 14.3. Drivers taking technicians on their boats will be penalised.
- 14.4. The winner can take his technicians for the victory parade lap only. A rescue boat will follow the winning team at close distance.
- 14.5. It is mandatory to use a low profile Front Head Restraint (FHR) that satisfied SFI 38.1 or FIA 8858 standards.
- 14.6. Seats are mandatory for F2 cockpits (for description see 509.08).
- 14.7. F2 cockpit boats must have UIM registered safety crash boxes installed on both sides of the safety cockpit.

14.8 One radio person is required per boat with adequate knowledge of English language. The radio persons are requested to wear the official PIT PASS with number of his/her boat, properly supplied by F.2 TA at the beginning of the season or during the first race attended by the boat. It is the responsibility of the radio person to have this official PIT PASS at any race.

The Radio persons are requested to wear their pass with the number of the boat when they are at the drivers meeting and when they are at race control for the practices and race. Failure of this rule means Euro 200 of penalty for the Driver.

- 14.9 The certified (or recertified) 6 strap/6 point minimum mounting system must be replaced according to the manufacturers recommended replacement interval or after an accident that results in structural damage to either the cockpit or hull; or injury to the driver. The manufacturer's certificate must be available and show the date of manufacture or recertification. If the restraint system has been involved in an accident as described above, the UIM Commissioner must cut the straps so they cannot be re-used.
- 14.10 Before the repechage race and the main race it is mandatory to have an inspection of the circuit; all drivers must get in the safety boats with the UIM Commissioner and have the instruction for the start and 1<sup>st</sup> buoy.
- 14.11 The Commissioner may require a boat to leave the course that has had its safety equipment compromised or damaged, (for example, lost pickle fork, open or lost cockpit canopy, etc.).

## 15. GENERAL

- 15.1. The official UIM sticker is mandatory and must be visibly displayed on all participating boats.
- 15.2. All TV, film, media and commercial rights are the property of the UIM.
- 15.3. The UIM contracted promoter if any handles the rights on behalf of the UIM.
- 15.4. Any organisation wishing to film or to use existing film must contact the promoter if any.

## 16. INSURANCE

- 16.1. The advance programme must contain following information:
- 16.2. Terms and conditions of a mandatory insurance for personal and material damage on third parties, competitors included
- 16.3. The minimum limit of coverage required
- 16.4. The type of risks to be covered by the insurance
- 16.5. Whether insurance from other National Authorities are authorised and if they are, in which language they must be drawn up.

All insurance produced by foreign drivers must also be written in English as well as their native language.

- 16.6. The amount of insurance fees to be paid on the spot (90€ maximum).

- 16.7. If a driver is not insured by their National Authority, or if the coverage of this insurance is insufficient, or if the driver cannot show the confirmation of the National Authority, or if foreign insurance are not authorized, an insurance must be purchased at the race meeting. The total cost must be stated in the advance programme (90 Euro maximum). In case of buying insurance at the race meeting drivers must receive a copy of the insurance certificate with an English translation and a receipt of paying for insurance. Insurance certificate should define coverage of insurance. It is the responsibility of the local organiser to ensure that they have sufficient insurance cover in place for the event.

## 17. FINANCIAL CONDITIONS

### 17.1. World Championship:

Travel Money Euro 15.000 =

Prize Money Euro 10.000 = Not refundable in case of cancellation within 45 days prior to the event

### Continental Championship:

Travel Money Euro 10.000 =

Prize Money Euro 8.000 = Not refundable in case of cancellation within 45 days prior to the event

All the National Authorities who have applied for a round of World or Continental Championship must pay to UIM bank account, within February 1st, a total amount of Prize Money, as a confirmation of their race. In case of cancellation of a F 2 WC or CC round within 45 days before the race, the prize Money sum paid by the Organizer of the Event to the UIM account, should be split equally amongst the Drivers having entered the Event(s).

To guarantee the final event of World Championship the Organizer of that event must pay Travel money to the UIM bank account, 10 DAYS BEFORE of the date of the penultimate event of the series.

### TRAVEL MONEY:

Euro 15.000 = World Championship

Euro 10.000 = Continental Championship

If the organizer can't pay travel money to the drivers in cash on the race spot, they must transfer the total amount of travel money to UIM bank account 30 days before the date of the event.

The total amount of travel money will be split among the drivers attending the race, as per list of distance in kilometres communicated by each driver.

### PRIZE MONEY:

Must be paid to the bank account of the drivers, the Tuesday or Wednesday after the race, as per following chart (less the bank charges):

WORLD	CONTINENTAL CHAMPIONSHIP	CHAMPIONSHIP
1° - Euro 2.500 =	1° - Euro 2.000 =	
2° - Euro 1.800 =	2° - Euro 1.500 =	
3° - Euro 1.500 =	3° - Euro 1.200 =	
4° - Euro 1.200 =	4° - Euro 900 =	
5° - Euro 800 =	5° - Euro 700 =	
6° - Euro 600 =	6° - Euro 500 =	
7° / 8° / 9° / 10° -	7° / 8° / 9° / 10° -	
Euro 400 = (each)	Euro 300 = (each)	



The total amount of the Prize Money not assigned to the drivers who are not placed (drivers absent or drivers who did not finish/did not start the race) will be assigned as follows:

- If the race is run by ten or more boats, the total amount of the Prize Money not assigned will be split among all drivers who have participated and who got points. (for example: 10 participating boats – 7 boats placed. Prize Money from 1<sup>st</sup> to 7<sup>th</sup> total Euro 8.800,00,= to assign to the drivers as per UIM F.2 rules – blue pages–. Prize Money not assigned from 8<sup>th</sup> to 10<sup>th</sup> total Euro 1.200,00= to assign in equal parts, among the drivers who get points;

- If the race is run by nine or less boats the total amount of the Prize Money not assigned (drivers absent/drivers who did not finish/did not start/drivers who are not placed) has to return to the organizer. (for example: 6 participating boats – 6 boats placed with points. Prize Money from 1<sup>st</sup> from 6<sup>th</sup> total Euro 8.400,00= to assign to the drivers as per UIM F.2 World Championship rules –blue pages-. Prize Money not assigned from 7<sup>th</sup> to 10<sup>th</sup> total Euro 1.600,00= to return to the organizer).

17.2. Any correspondence regarding F2 must be sent to the following address:

UNION INTERNATIONALE MOTONAUTIQUE

STADE LOUIS II - ENTREE H

1 AVENUE DES CASTELANS

MC 98000 MONACO

Fax: (377) 92-05-04-60

E-mail: [uim@uim.sport](mailto:uim@uim.sport)

Website: [www.uim.sport](http://www.uim.sport)



# **FORMULA 500 RULES 2022**

**Published on 22/12/21**

«Dieter König Memorial»

1. ORGANISATION
2. RACE FORMAT
3. CLASSIFICATION
4. STOPPED RACE
5. YELLOW CARDS
6. COMMITTEE OF APPEAL
7. SAFETY
8. GENERAL

## INTERPRETATION OF THE RULES - 200.02

In all cases unforeseen by the international rules, the National Authority is to judge bearing in mind the spirit of the rules. In case of conflicting rules, those rules concerning the series are to prevail.

### 1. ORGANISATION

The organisation of F500 races and championships is owned and ruled by the UIM.

The Council may update the rules whenever necessary, only if the Formula is promoted by a contracted promoter.

Meetings in Formula 500 are reserved to boats of the O series, equipped with 351 cc to 500 cc outboard engines.

The championship is open to all drivers (their number per National Authority being unlimited) who will produce evidence that they have participated satisfactorily in at least 5 international or national races in the O series.

The official UIM sticker is mandatory and must be affixed on all participating boats.

### 2. RACE FORMAT

The Championship includes a minimum of 4 and a maximum of 6 races organised in different countries, with a minimum interval of two weeks between races if possible. The UIM reserves the right to allocate the Championship even if the minimum number of races are not held or awarded points.

Applications to hold a F500 event will be allocated in the normal way (rule 108.01, but using the English names of the country applying) except that one National Authority can be allocated two events provided the maximum number has not been requested by other National Authorities.

Except a maximum of 4 races to be included in Hydro GP takes priority during allocation by

Cominsport. All races run with points allocated will count for the final classification.

All races must use jetty starts (rule 307).

#### CIRCUIT:

The length of the lap will be included between 1500 and 2000 meters;

- The length of a qualifying heat will be included between 8 and 12 km;
- The number of boats authorised on the circuit must be announced in the advance-programme.

#### RACE:

Each race will include 3 final heats. If the number of drivers present exceeds the number admissible on the circuit, qualifying heats will take place.

The composition of qualifying heats will be determined by the classification of official timed trials: drivers with an odd position (1, 3, 5, etc...) will be put together in one series, drivers with an even position (2, 4, 6, etc...) in the other series. Drivers who have not participated in trials will be split between the qualifying heats.

Each series will run a selection heat and certain drivers a supplementary heat. Example based on the presence of 30 boats on a circuit authorised for 14 boats: 3 series of 10 boats will be formed:

At the end of the selection races for these series, the 4 first of each series will be selected (3x4=12).

The supplementary heat will be run by the 14 non selected drivers with the greatest point totals, the two first of this heat will be selected to participate in the final (1x2=2) giving a total for the final of 12+2=14 drivers. They are positioned at the lower end of the jetty for the first heat.

If necessary, after all the qualifying races, the organisers reserve the right to make up the number of boats in the final races to the maximum permitted from the repechage heat, when any qualified driver indicates that they cannot participate in the final heats. This cannot be done after the first heat.

An interval of at least one hour will be mandatory between final heats and between the last qualifying heat and the first final heat.

If the qualifying heats are of a different number of laps-positions on the jetty for the final races are from lap times - if not available then the positions in which they finish their heat will be intermingled - the first being the winner of the longest qualifying heat.

#### **START:**

The distance between the start line and the first turn mark must be at least 300 metres in a straight line.

At dead engine starts, the drivers must keep their relative positions to the first turning buoy and through completion of that turn, not interfering in the path of competing boats. Sufficient room on the inside must be left by the leading boat, if not pole, to allow others higher on the jetty to negotiate the turn. From then on it is the ordinary rules of the road. The inclusion of a mandatory starting buoy for safety reasons does not count as the first turning buoy when keeping your lane.

Breaking this rule will result in one or more of the following penalties, which are disqualification, one lap penalty or a yellow card, depending on the severity.

At all dead engine starts at international titled races, the start may be videotaped (or similar). This is to be done from a position as high as possible and/or from a place in extension of the start lane.

### **3. CLASSIFICATION**

The classification of the race will be drawn-up by adding up each driver's points in every final heat (scale referred to in article 317.01).

In order to obtain a general classification of the Championship, the first drivers classified in races taken into account in a championship will be given points as follows:

1st:	20 points	6th:	10 points	11th:	5 points
2nd:	17 points	7th:	9 points	12th:	4 points
3rd:	15 points	8th:	8 points	13th:	3 points
4th:	13 points	9th:	7 points	14th:	2 points
5th:	11 points	10th:	6 points	15th:	1 point

The winner of the Championship will be the driver who will have accumulated the highest number of points.

In case of a tie, the number of first positions, second positions etc. will be successively taken into consideration.

In case of a new tie, all UIM points collected in all races counting for the Championship will be added up (scale referred to in article 317.01) applied to the general classification of each event.

At the last race of the series UIM will provide three medals (gold, silver, bronze) to be given to the three first classified in the general classification.

## 4. STOPPED RACE

A stopped race is a race which has been interrupted by the Officer of the day after the start.

Stopping the race is decided by the Officer of the Day for reason of force majeure of which he is the sole judge. A race must be stopped when any body is in the water as a result of an accident (blow over, roll, submarining, collision, etc...) as the continuation of the race constitutes a danger to those involved.

A stopped race may only be repeated twice.

- a) A stopped race must be repeated twice if necessary
- b) When the leading boat has completed less than 70 % of the required laps the race shall be re-started.
- c) First restart, full number of laps, refuelling is allowed.
- d) Only drivers scored on the lap before the stoppage, can restart.
- e) If a first re-started race is also stopped before 70 % of the required laps have been completed by the leading boat, the race shall have a second start.
- f) A second restarted race does not allow refuelling.
- g) Laps for a second restarted race shall be:

Add 1 lap to the full number of laps completed before the stoppage - take these away from original number of laps - new race distance.

Example: restarted race stopped on lap 4 in an 8 lap race: 3 laps completed + 1. 8 laps - 4 = 4 laps for second restarted race

- h) If a second restarted race is also stopped: results - up to 35 % of required laps 50 % points. 35 % and over = full points.
- i) Any penalty incurred in any race is carried forward to any restart of that race.

If two repeated races are provided for in the advance programme, the first one must be a complete race (total number of foreseen laps) and the second one according to the following format.

If only one repeated race instructions will be given in writing to the drivers during a special drivers meeting.

No refuelling is allowed between a stopped race and a repeated race, except if the repeated race is a complete heat.

Only the drivers scored at the lap before the stop, are allowed to restart. Points will be awarded according to the following system:

up to 35% of the distance	1/2 points
above 35% of the distance	total points

## 5. YELLOW CARDS

Yellow cards can only be given for the behaviour on the water. A yellow card will be confirmed on a form which will be posted with the results. The Driver has 60 minutes to protest to the jury. If the protest is not accepted, he can appeal. Protests and appeals can be lodged according to UIM rules.

A yellow card can be given by:

- Officer of the Day;
- the UIM Commissioner.

The yellow card can be given according to the following:

- up to two yellow cards at a time for dangerous driving;
- red card for extremely dangerous driving.

A driver who has been given three yellow cards or a red card loses his right to take part in the following competition of the World Championship (current season or following season).

All cards remain valid for the four following competitions of the Championship as from the date on which the last card was delivered. When the penalty of not racing at the next race has been applied, the 3 yellow cards are deleted through the penalty.

Timed trials, qualification race and final race count as one event.

An organiser/N.A. who has given one or more yellow cards to a driver must inform UIM by telefax or mail within 3 days. UIM will inform the next organiser/N.A. of a World Championship race or the Continental Championship about the delivery of such yellow cards. When a driver has done 4 races without yellow cards, his previous card(s) will be deleted from the listing.

Given yellow cards must be mentioned in the commissioner's report which must be distributed to all members of the relevant UIM Formula commissioners panel.

## 6. APPEAL PROCEDURE

Appeals will be handled according to the provisions of Art. 405. The time limit to appeal is counted from the moment of the communication of the Jury decision to the interested parties and it is 48 hours. The 24 hours of the race day do not count within the 48 hours to appeal.

Address, telephone and fax should be clearly mentioned on the appeal so that the UIM can send any correspondence directly to the driver with copy to his/her N.A. The driver may agree on having no UIM International Court of Appeal meeting but to handle the appeal through telecommunication channels - if possible - in order to limit the costs of the appeal.

## 7. SAFETY

Reinforced cockpits are mandatory according to rule 509. Before racing a craft with restraint system, all drivers must have passed an immersion test in a restraint system to ensure that they can exit a reinforced compartment successfully.

The immersion certificate should be provided by the National Authority of the driver and includes an immersion test in a simulated reinforced cockpit. The immersion test and the certificate must be renewed every 14 months.

A model for the certificate and instructions of how to perform an immersion test are available at the UIM Secretariat **and/or UIM website**. All catamaran type hulls must have the deformable pickle forks according to rule **509.02**.

Drivers must wear of flotation vest so constructed at the shoulders that a driver can be easily pulled of the cockpit.

Seats are mandatory for F500 cockpits. Bead or foam construction of the seat is permissible. See 509.08.

## 8. GENERAL FINANCIAL CONDITIONS

1720 € prize money:

Distributed by the organiser to the drivers at the end of the race, before they leave the racing place (after the end of the protest time).

1st:	370 €
2nd:	250 €
3rd:	200 €
4th:	180 €
5th:	170 €
6th:	150 €
7th:	130 €
8th:	100 €
9th:	90 €
10th:	80 €

6000 € travelling money:

Travelling money for foreign drivers is to be divided equally between the registered competing foreign drivers to a maximum of 600 €. Drivers who fail to send in their registered entry forms in due time, according to the advance programme/regulations, may lose all their travel money.

A "foreign" driver is one that has a valid International License issued by a National Authority other than the "host" Country.

All prize and travel money must be paid in Euro. Organisers unable/unwilling to pay in Euro will have to pay an increase of 10 % on all the amounts due to the drivers. Alternatively organizer pays prize and travel money to the driver bank account latest next Wednesday after the race is over. Bank transfer costs are paid by race organisers in this case. All local taxes are paid by race organizers in behalf of driver. Driver gets money defined in UIM Rule Book.

All TV, film, media and commercial rights are the property of the UIM.

If the UIM has a contracted promoter, he handles the rights on behalf of the UIM.

Any organisation wishing to film or to use existing film must contact the UIM or the promoter. Any correspondence regarding Formula 500 must be sent to the following address:

UNION INTERNATIONALE MOTONAUTIQUE  
STADE LOUIS II - ENTREE H  
1 AVENUE DES CASTELANS  
MC 98000 MONACO  
Fax: (377) 92-05-04-60  
[E-mail: uim@uim.sport](mailto:uim@uim.sport)  
[Website: www.uim.sport](http://www.uim.sport)



# **FORMULA 4 RULES 2022**

**Published on 22/12/21**



1. ORGANISATION
2. RACE FORMAT
3. START
4. STOPPED RACE
5. INTERRUPTED RACE - PACE BOAT RULES
6. CIRCUIT
7. CLASSIFICATION
8. ENTRIES
9. YELLOW CARDS
10. PROCEDURE FOR PROTEST AND APPEAL
11. SAFETY
12. GENERAL

## **INTERPRETATION OF THE RULES - 200.02**

In all cases unforeseen by the international rules, the National Authority is to judge bearing in mind the spirit of the rules.

In the case of conflicting rules, those concerning the series are to prevail.

### **1. ORGANISATION**

The organisation of F4 races and championships is owned and ruled by the UIM.

The Council may update the rules whenever necessary, only if the Formula is promoted by a contracted promoter. F4 races are reserved for boats of the F4 class and are governed by the relevant 540 rules.

The F4 World Championship is open to all drivers (their number is unlimited for each National Authority).

### **2 RACE FORMAT**

The Championship consists of a maximum of three (3) events in different countries consisting of two (2) races each, with a minimum interval of two weeks between events if possible. Each event will take place over two days, one race each day.

Applications to hold an F4 event will be allocated in the normal way (rule 108.01) except that one National Authority can be allocated two events provided the maximum number has not been requested by other National Authorities. Any events allocated by the UIM Council should be counted within the three (3) events.

Should an event be cancelled it should only be reallocated on the same date as the cancelled event, should this not be possible the event should not be re-allocated.

A UIM Commissioner is required at each race.

### **CIRCUIT**

The length of the lap will be between 1000 to 1500 metres with a maximum of 600 meters for any one straight. The length of the heats will be between 25 to 30 km.

The number of boats authorised on the circuit must be announced in the advance programme.

## RACE

Each race weekend will be a two day event where each day consists of 1) Free practice, 2) Qualifying 3) Qualifying Race 4) Race.

### 1. Free practice

45 minutes (minimum 45 minutes each free practice) If the number of entries exceeds the maximum authorised on the circuit, then the organizer must separate into several groups, by ballot at drivers meeting.

There should be a minimum of one hour between the end of practice and the qualifying session.

### 2. Qualifying

If the number of entries exceeds the maximum authorised on the circuit, then the organizer must separate into several groups, by ballot at drivers meeting.

### - Q1 or Q2:

If a Yellow Flag is used at any time during Q1 & Q2 sessions then timing will be stopped. Boats may continue to use the course but they must stay clear and reduce their speed in the vicinity of the area where there is an issue. If the session time is still 'running' the time taken to resolve the issue on the course will be added to the already elapsed time. If the session timing was stopped, this will resume when the green flag is raised.

If a Red Flag is used at any time during Q1 or Q2 all boats must immediately reduce speed and safely return to the pontoon to await further instruction. Timing will be stopped during any Red Flag situation and when the issue is resolved, the course will be opened and timing will resume for remainder of the outstanding time required by the rules.

Any competitor not respecting the flag signals will be penalised.

- Q1: All boats may run laps at any time during the first 22 minutes of the hour. Timing of the boats will start 2 minutes after the green flag. At the end of the first 22 minutes, only the fastest 15 boats will remain in the water, the excluded boats will fill the final grid positions.

If the number of entries exceeds the maximum authorised on the circuit, then the organizer must separate into several groups

Drivers who were excluded from the Q2 (position 16 and up) have to start in the Qualifying race.

- Q2: After a five minute break, the 15 remaining boats' times will be reset to zero and they will then run a further 17 minutes session. Timing of the boats will start 2 minutes after the green flag. Again the boats may complete as many laps as they want during the 17 minute session. At the end of Q2, the nine slowest boats will be dropped out and fill positions 7 to 15 on the start grid.

- Q3: Each remaining boat will run an individual two lap timed trial. The running order will be from the finishing positions in Q2, starting with the 6th position boat.

If a driver is deemed to have stopped unnecessarily on the circuit or impeded another driver during qualifying, his times may be cancelled.

No refueling allowed during the full qualifying session (Q1, Q2, Q3).

### 3. Qualifying race

If the number of entries exceeds the maximum authorised on the circuit. Must be a Qualifying race run.

The composition of the qualifying race will be determined by the results obtained in the Q1 (When you divide the groups and positions on the jetty)

The drivers who have not taken part in the Q1 start in the end off jetty and be distributed between the groups.

Qualifying race running 10-12 laps

If it is more than 1 group the time in the heat is the positions

If the qualifying race are of a different number of laps positions for the final races are from lap times

There should be a minimum of one hour between the end of Qualifying and Qualifying race and the Race session.

#### 4. Race of 20-25 laps

Each weekend will, by this, always consist of two races which will be counted individually with the point system 20, 17, 15...

Options for the prize giving ceremony :

1. The prize giving ceremony will be held after race two, the winner will be the driver that has collected the most points during the two day's events. If two drivers have the same points after two days of racing the driver with better result in the second race will be declared the winner of the weekend for prize giving purpose. Championship points will still be allocated for each race.
2. Alternatively a prize giving ceremony may take place after each race.

Should the number of drivers present exceed the number admissible on the circuit qualifying heats will have to be organised. The composition of the qualifying series will be determined by the results obtained at the official timed trials: drivers in an odd-numbered position (1, 3, 5...) will be in one series, those in an even-numbered position (2, 4, 6...) will be in another series.

The drivers who have not taken part in the timed trials will be distributed between the two series. For each series there will be a selection race and some drivers will run a second chance race.

Example based on 30 boats on a circuit planned for 20 boats: There will be two series of 15 boats.

At the end of the selection races for these series the first eight boats in each series will be selected ( $2 \times 8 = 16$ ).

The second chance heat will be run by 14 unselected drivers; then the first four in this heat will be allowed to take part in the final race ( $1 \times 4 = 4$ ), this is to say the total number of  $16 + 4 = 20$  drivers for the final. The drivers from the second chance heat will start at the end of the grid in the first heat.

An interval of one hour will be mandatory between final heats and between the last qualifying heat and the first final heat.

If the qualifying heats are of a different number of laps positions on the jetty for the final races are from lap times – if not available then the positions in which they finish their heat will be intermingled – the first being the winner of the longest qualifying heat.

If necessary, after all the qualifying races, the organisers reserve the right to make up the number of boats in the final races to the maximum permitted from the repechage heat, when any qualified driver indicates that they cannot participate in the final heats. This cannot be done after the first heat.

### 3. START

The start will be dead engine start, as follows:

Boats drawn up stern first, engine dead, to a jetty, a floating stage or beach.

The distance between the starting line and the first turning buoy must be at least 300 meters.

When the jetty marshal is satisfied that all drivers are ready to start, with engines stopped, he raises the green flag. The O.O.D. or starter will commence the start procedure.

The two minute board is shown.

One minute before the red light is switched on a '1' minute board is shown. 30 seconds before the red light is switched on a '30' board is shown.

Engines must not be run after this signal.

At the end of 30 seconds the red light is switched on.

After 5 – 12 seconds the red lights are switched off, this is the signal to start.

All information start boards are shown for their applicable time.

Those drivers running their engines during the last 30 seconds before the start are disqualified. Those drivers starting their engines or leaving the jetty whilst the red light is on lose one lap.

Those drivers rotating their engines (with ignition switched off) prior to the red lights going off lose one lap. After an announced time the red light will be shown again.

Late starters: A driver who has failed to start before the red light is shown again, must wait until the whole field has passed the start jetty and the jetty marshal indicates that he may join the race in the proper way.

Any boat starting unsuccessfully must be returned to the shore. Any crew member swimming, or wading, out to a boat will cause his entry to be disqualified.

#### **4. STOPPED RACE**

- 4.1. In the event that a race is completely stopped rule 311 will apply.
- 4.2. Upon showing the red flag, drivers must return slowly under their own power to the start pontoon [or other position on the circuit notified by the UIM Commissioner during drivers' briefing].
- 4.3. Drivers receiving outside assistance at any point during the race (whether the race has been stopped for an incident or not) will be disqualified.
- 4.4. Boats that have broken down and received outside assistance by being pulled to the infield, or off the race course, will be towed to the trailer or the starting dock only during a "race stop" condition and if pick-up boats are available.
- 4.5. Repairs are allowed at any time during the race, with the exception that replacement of the crankcase and the cylinder block is prohibited. Repairs are not allowed on the race course using outside assistance.
- 4.6. Only if a boat reaches the pontoon on its own power, repairs can be carried-out either while the boat is completely in the water or on its trailer, at the sole discretion of the Pontoon Marshal. Further instructions for the repair areas may be given at drivers briefing.
- 4.7. No repairs are allowed on the start pontoon during the line-up and start or re-start preparations.
- 4.8. Drivers may carry-out their own repairs on their boats in accordance with the rules. The driver's two nominated pontoon mechanics and the official crane driver do not count as outside assistance.
- 4.9. In the event of a restart a boat being repaired must be ready to take its position on the grid as directed by the Pontoon Marshal. If the boat is not ready to take its position, it must start at the end of the pontoon.
- 4.10. Hulls and motors must be sealed after scrutineering and before practice. In races with several restarts, substitution of hull or motors between the restarts or during the race is prohibited.
- 4.11. To qualify for points, a stopped race must be restarted if 70% of the total distance specified for the race has not been covered at the time the race is stopped.
- 4.12. The number of laps completed + 1 lap per restart will be deducted from the restarted race.
- 4.13. Should there be a restart, starting positions will be determined by the order of the end of the lap prior to the race being stopped.
- 4.14. All boats which are ready to race, may start in a restarted race.

#### **5. INTERRUPTED RACE - PACE BOAT RULES**

- 5.1. The Organiser may interrupt the race for any reasons of safety or emergency services access, and in which case the rescue boats and race control will show yellow flags.
- 5.2. At this signal all drivers must immediately slow down and not overtake. Any overtaking, 5 seconds after the yellow signal has been given, will be penalised by 1 lap. The leading boat, or a specially designated boat, will act as pace boat, and run at slow speed. The leading boat's (pace boat) radio person shall stay next to the OOD (or UIM Commissioner) and transmit the instructions to the driver.
- 5.3. When the race course is clear, only the yellow flag at race control will be continued to be shown.
- 5.4. All boats maintain their position at slow speed (approx. 4000 rpm) until race control raises the green flag. It is the responsibility of the team managers to ensure that their boat(s) are in the correct position at the restart.  
If a boat, in any position on the water is judged to be speeding or causing a hazard under the yellow flag during a pace boat situation, they may receive a drive through or 1 lap penalty.

- 5.5. When a rolling re-start is used, the UIM Commissioner can restart the race by showing a green flag at any point on the race course. The first 10 boats must be in their correct positions before the race can be restarted. The position of the boats for the rolling restart will be that of their race positions on the lap before the yellow signal was given.
- 5.6. Boats which do not restart in their correct position, will be given a one lap penalty..
- 5.7. During the yellow signal situation, a boat may leave the race course but must re-join the race behind the boat running in last position.
- 5.8. In races run with the pace boat system in operation, a yellow flag will be used by race control and the rescue boats to indicate a hazard when displayed stationary, and extreme caution to be exercised by drivers when waved vigorously. No overtaking permitted during yellow flag status.

## 6. RACE COURSE

Water Registration – see rule 106.02

Course and safety rules will be those of the UIM applicable on the date of the race unless specified otherwise by these rules.

The length of straight between any two turning buoys is to be a maximum of 600m, (the length of the straight from the jetty to the first turn buoy may exceed 600m). The boundaries of the water on which practice and racing are allowed to take place must be defined in the advance programme.

Every turn on the race course must have two turn buoys. If a driver

- Touches the first turn buoy in a turn no penalty;
- Damages or destroys the first buoy: one lap penalty;
- Touches the second buoy: no penalty;
- Damages, destroys or dislodges the second buoy: disqualification and a fine that will be decided by the Organising Committee and announced in the advance regulations;

The penalty lap will be deducted at the end of the heat. Cost of destroying a buoy is maximum 200 euro.

When passing a mark and an overlap has been established, both boats must maintain their lane, i.e. they must maintain their distance from the mark until the mark has been rounded.

### PARC FERME

The top three classified boats will be weighed with scales after time trials and the race. The weighing of the boats cannot be protested. The scales will be available before the meeting commences.

The top three finishers of the timed trials and race must immediately take their boats to the parc ferme/ UIM tent, without stopping on the way and without touching, replacing or modifying anything.

After the shoot out and the race, the drivers qualified in 4th-5th-6th positions are to wait in the water or at designated area until the top three finishers have been approved and the OOD/ UIM Commissioners dismiss them.

Upon request of the UIM Commissioner, drivers must allow to be weighed separately. Not complying will bring immediate disqualification.

## 7. CLASSIFICATION

In order to obtain a general classification of the Championship, the first drivers classified in races taken into account in a championship will be given as follows:

1 <sup>st</sup>	20 points	6 <sup>th</sup>	10 points	11 <sup>th</sup>	5 points
2 <sup>nd</sup>	17 points	7 <sup>th</sup>	9 points	12 <sup>th</sup>	4 points
3 <sup>rd</sup>	15 points	8 <sup>th</sup>	8 points	13 <sup>th</sup>	3 points
4 <sup>th</sup>	13 points	9 <sup>th</sup>	7 points	14 <sup>th</sup>	2 points
5 <sup>th</sup>	11 points	10 <sup>th</sup>	6 points	15 <sup>th</sup>	1 point

The winner of the Championship will be the driver who will have accumulated the highest number of points.

In the case of a tie, the number of first positions, second positions etc. will be successively taken into consideration.

In the case of a new tie, the driver classified in the higher position in the last Championship race gets the higher position in the general classification of the Championship.

At the last race of the season the UIM will provide three medals (gold, silver, bronze) to be given to the three first classified in the general classification.

## 8. HULL

- 8.1. Hull must be a catamaran type, based on twin hulls, but may be of completely free hydrodynamic and aerodynamic design.
- 8.2. Must conform to the general UIM rules 501; 503; 504; 505; 508; 509; 542.05 and these F4 rules.
- 8.3. Boats configured to work on the hydrofoil principal will not be eligible.
- 8.4. The minimum hull length is 3m90.
- 8.5. The minimum weight of the boat and driver as raced is 360 kg
- 8.6. Measured in accordance with rule 542.12.
- 8.7. Each wing mirror must have minimum size of 60 sq. cm and be bolted on 2 points to assure proper mounting.
- 8.8. Radios in boats are mandatory and a full radio check of each boat will be part of technical scrutineering in order to guarantee that all radios are working. The radio person, clearly identified with the racing number of his boat, must be present at race control whenever his boat is on the course. Failure to observe this rule will be penalised by a blue card for the Driver. In order to guarantee clear communication between the Team Managers and the OOD/ UIM Commissioner, all Team Managers must speak English.
- 8.9. Hull, sponsons, and powerhead replacements and other parts are allowed after scrutineering, up until the end of timed trials, but any changes to be made must be immediately notified to the OOD/UIM technical Commissioner for re-scrutineering and sealing and technical inspection of units removed.
- 8.10. Any replacement of boat powerhead or sponsons after qualifying time trials will result in all previous times achieved being cancelled, and the replacement boat powerhead or sponsons will be considered as a new entry, requiring full scrutineering. If no timed practice opportunity remains, the boat will start from the end of the grid.

## 9. ENGINES

- 9.1. The Mercury 60. 15" engine, homologation file no. 00500, unaltered, is a legal engine in F4.
- 9.2. The Mercury 60. 15" engine homologation file no. 00500 may not be modified in any manner.
- 9.3. As advertised 60HP
- 9.4. rule 543 machinery
- 9.5. rule 543.09 Sole modification allowed
- 9.6. rule 543.10 Modifications not permitted on low emission engines

## 10. SERIESLICENCE

- 10.1. The UIM F4 Serieslicence is required for the F4 Continental and World Championships and gives to the drivers the following rights :
- To receive proportional travel money for competing at World Championship & Continental Championship events as provided by the specific championship rules.
  - To win a portion of the prize money for when competing in World Championship & Continental Championship events as provided by the specific championship rules
  - To receive a UIM medal if the competitor is placed in one of the top 3 positions of the World Championship or Continental Championship.
  - To get the UIM points for competing at a World championship & Continental Championship event
  - F4 Serieslicence holder will not have to pay for a wet UIM ECU at the race site.

The Serieslicence listing will be emailed one week before the event to the UIM commissioner nominated for the event and the hosting National Authority.

- 10.2. The nationality of a driver is the nationality of the N.A. which issued the international racing licence to the driver. Immersion training can be done in other countries if the issuing N.A. agrees. The flag is the one of the issuing N.A. of the international licence as above. The request for the UIM Superlicence must come from the N.A. which issues the international racing licence.
- 10.3. Drivers must hold a UIM Serieslicence before entry will be accepted.
- 10.4. The Serieslicence is required for F4 together with the NA international Licence. No other membership is required.
- 10.5. The application for a Serieslicence must be made by the National Authority of the driver and lodged with the UIM 4 weeks before the first event the driver wants to participate in. The Serieslicence fee of 100 Euro will be doubled for applications received beyond the 4 weeks deadline. No application will be taken in consideration within one week from the following event. The National Authorities will be informed that any application and the relevant application documents will have to be uploaded on the private area of the UIM website (like the others SL)
- 10.6. The application must be accompanied by:
- The sports career of the driver, mentioning the results obtained in the qualifying events; (should be only basic, this is entry level.
- 10.7. General Recommendation for F4 Serieslicence holders concerning physical fitness. This is only a recommendation, the driver does not have to submit a medical certificate.
- Cardiovascular training (endurance training) as jogging, cycling, rowing etc. twice a week - minimum 20 minutes without any interruption. Any sports activity which has "stand still" during the activity such as soccer, tennis or any ball sport is not suitable for endurance training, but recommended as additional training;
  - Training to build up muscles for neck and back at least twice a week
  - The immersion certificate (ref 205.05)
  - A photo
- 10.8. The fees will be fixed by the UIM Council and paid to the UIM Secretariat. F4 Serieslicence fee is fixed to 100 euros. For late application, the serieslicence fee has been fixed to 200 euros and must be paid to the UIM Secretariat.
- The digital version of the rulebook will be made available to the driver along with the Serieslicence.
- 10.9. The National Authorities are responsible for the information given.
- If any F4 Serieslicence holder participates in an international event not sanctioned by the UIM, their Superlicence may be withdrawn.
- The driver may re-apply for the F4 Serieslicence after 12 months from the date the original Serieslicence was withdrawn.
- 10.10. For renewal of the F4 Serieslicence, the National Authorities must, before the end of December, send to the UIM a list of the drivers for whom a renewal for the following year is required.

## 11. PENALTY CARDS

For yellow, red and blue card penalties see rule 406.05. Temporary suspension: see rule 406.07.

## 12. PROCEDURE FOR PROTEST AND APPEAL

12.1. A protest can be lodged in accordance with the 400 jurisdiction rules either by the driver or the team manager. Appeals will be handled in accordance with Art. 405

13.2. The time limit to appeal is counted from the moment of the communication of the Jury decision to the interested parties and it is 48 hours.

13.3. The 24 hours of the race day do not count within the 48 hours to appeal. Address, telephone and fax should be clearly mentioned on the appeal so that the UIM can send any correspondence directly to the driver with copy to his/her N.A.

13.4. The driver may agree to forego the UIM International Court of Appeal meeting and for the appeal to be handled through telecommunication channels, if possible, in order to minimize the costs of the appeal.

## 13. SAFETY

Reinforced cockpits are mandatory according to rule 509.

Before racing a craft with restraint system, all drivers must have passed an immersion test in a restraint system to ensure that they can exit a reinforced compartment successfully.

The immersion certificate should be provided by the National Authority of the driver and includes an immersion test in a simulated reinforced cockpit. The immersion test and the certificate must be renewed every 14 months.

A model for the certificate and instructions of how to perform an immersion training are available at the UIM Secretariat.

The deformable pickle forks are mandatory according to rule 509.02. Life jackets incorporating pants, are mandatory.

Drivers must wear a life jacket so constructed at the shoulders and the legs, that a driver can be easily pulled out of the cockpit.

Flotation overalls are a permitted alternative to life jackets, but must incorporate extraction handholds for driver removal from the cockpit.

It is recommended that the colour of the floating overalls is orange. Seats are mandatory in F4.



## 14. GENERAL

### FINANCIAL CONDITIONS

2000 € prize money: Distributed by the organiser to the drivers at the end of the race, before they leave the racing place (after the end of the protest time). World Championship & Continental Championship

1st: 350 €

2nd: 275 €

3rd: 225 €

4th: 200 €

5th: 175 €

6th: 150 €

7th: 100 €

8th: 75 €

9th: 75 €

10th: 75 €

11th: 75 €

12 th: 75 €

13 th: 50 €

14th: 50 €

15th: 50 €

3000 € travelling money: World Championship & Continental Championship

Each National Authority wishing to organise an F4 event will have to guarantee the amount of 3000 Euro to be paid as Travel Money and divided equally between the registered competing foreign drivers who successfully start in either time trial, qualifying heat or race to a maximum 250 EUR per driver (the nationality shown on driver's international license). All local taxes are paid by race organizers. Driver gets money defined in UIM Rule Book. Drivers who fail to send in their registered entry forms in due time, according to the advance programme/regulations, may lose all their travel money. Travel money must be paid in Euro. Organisers unable/unwilling to pay in Euro will have to pay an increase of 10 % on all the amounts due to the drivers. Travel money must be distributed by the organiser to the drivers at the end of the race, before they leave the racing place (after the end of the protest time). Alternatively organizer pays travel money to the driver bank account latest next Wednesday after the race is over. Bank transfer costs are paid by race organisers in this case. All TV, film, media and commercial rights are the property of the UIM.

The UIM contracted promoter, if one is appointed, handles the rights on behalf of the UIM.

Any organisation wishing to film or to use existing film must contact the promoter.

All correspondence related to the F4 World Championship should be sent to the following address:

UNION INTERNATIONALE MOTONAUTIQUE

STADE LOUIS II – ENTRÉE H

1 AVENUE DES CASTELANS

MC 98000 MONACO

Fax: (377) 92-05-04-60

E-mail: [uim@uim.sport](mailto:uim@uim.sport)

Website: [www.uim.sport](http://www.uim.sport)



# **FORMULA 1000 RULES 2022**

**Published on 22/12/21**

1. DENOMINATION
2. HULL
3. MOTOR
4. PROPELLER
5. FUEL
6. YELLOW CARDS
7. COMMITTEE OF APPEAL
8. SAFETY
9. GENERAL

## TECHNICAL RULES

### 1. DENOMINATION

The Formula 1000 European Championship is an outboard monobrand class. The Championship includes up to 4 races organised in different countries.

The final classification of each of these four events will be calculated using the drivers' best three heats and the 25 % reducing points system (400, 300, 225 etc).

The programme of the event must include free practice of minimum 60 minutes.

The overall classification of the European Championship will be calculated by awarding points for positions in the final classification of each of the four events using the 20, 17, 15 etc points system.

The heat distance will be 20 to 25 km.

### 2. HULL

- 1.1. The hull must be of a catamaran type provided with safety cockpit and pickle-forks in accordance with the UIM rules. The minimum dimensions must be the following:
  - minimum length 3,90 m;
  - minimum weight of the boat 250 kg (325 kg with driver) immediately after the race with residual fuel and without residual water.
- 1.2. Radios in boats are mandatory and a full radio check of each boat will be part of technical scrutineering in order to guarantee that all radios are working. The radioman must be present at race control whenever his boat is on the course. In order to guarantee clear communication between the Team Managers and the UIM Commissioner, all Team Managers must speak English.

### 3. MOTOR

The motor must be a SELVA FORMULA 1000 homologated by UIM.

The electric supply of the system must be 12 Volt (including trim system).

The lift system is mechanic and must be not modified. Any machinery aimed at modifying the height of the motor during the race is forbidden.

Carburettors must remain standard in any of their parts.

Cylinder sleeves cannot be substituted and cannot undergo any remarking.

The cooling water must circulate through the water pump and be fed only through the standard water intake, neither the position nor the shape of which may be modified.

The use of non SELVA parts are forbidden. Sole modifications allowed:

- eding into combustion chamber), propeller nut;
- It is permissible to use any fuel line or fittings. A fuel filter may also be used;
- It is possible to add a fuel supply electric pump without changing the original system of engine supply;
- It is permissible to replace original carburettor jets for another size.
- It is possible to repair or remake the engine cover maintaining the inlet airflow measures.

Reworking of the parts is allowed within the manufacture geometrical dimension tolerances as from the technical schedule provided by the manufacturer.

When exhaust ports in cylinders are adjusted to the dimensions specified in the homologation sheet, material may only be removed in the specified opening to match the shape of the original adjacent connecting passage (channel) outside the adjusted port opening.

In order not to modify the crankshaft balancing of the standard production engine it is not allowed to remove or add material, in any way, to the components of crankshaft, connecting rods, complete pistons, bearings and pins assembly.

Apart from the above provisions, it is absolutely forbidden to make any alterations to the engine manufacturers standard components either by removal or addition of material. In particular this includes components being subjected to any form of machining, grinding, hand tooling, reworking, reshaping, fettling, polishing etc. unless it is specifically permitted.

The driver is responsible for the condition of the engine as raced. Errors on the part of one manufacturer, mechanic or previous owner is no excuse.(525.2.02.19)

Post race inspection should follow rules 503.04

#### 4. PROPELLER

The propeller must not have more than 4 (four) blades.

#### 5. FUEL

The fuel must be of commercial type used for automobile. Lubricating oil for cylinder head or for 2-stroke motors may be added to the fuel.

The use of additives aiming at increasing the power of the motor is prohibited either to the fuel (carburant) or to the air intake (comburant).

No refuelling will be allowed when the boat is not on its trailer.

When fuel is available at race site, minimum 92 octane, and the specification and price is printed in the advance programme, all competitors must use the specified fuel.

#### 6. YELLOW CARDS

Yellow cards can only be given for the behaviour on the water. A yellow card will be confirmed on a form which will be posted with the results. The Driver has 60 minutes to protest to the jury. If the protest is not accepted, he can appeal. Protests and appeals can be lodged according to UIM rules.

A yellow card can be given by:

- the Officer of the Day;
- the UIM Commissioner.

The yellow card can be given according to the following:

- up to two yellow cards at a time for dangerous driving;
- red card for extremely dangerous driving.

A driver who has been given three yellow cards or a red card loses his right to take part in the following competition of the World Championship (current season or following season).

All cards remain valid for the four following competitions of the Championship as from the date on which the last card was delivered. When the penalty of not racing at the next race has been applied, the 3 yellow cards are deleted through the penalty.

Timed trials, qualification race and final race count as one event.

An organiser/N.A. who has given one or more yellow cards to a driver must inform UIM by telefax or mail within 3 days. UIM will inform the next organiser/N.A. of a World Championship race or the Continental Championship about the delivery of such yellow cards. When a driver has done 4 races without yellow cards, his previous card(s) will be deleted from the listing.

Given yellow cards must be mentioned in the commissioner's report which must be distributed to all members of the relevant UIM Formula commissioners panel.

## 7. COMMITTEE OF APPEAL

Appeals will be handled according to the provisions of Art. 405.

The time limit to appeal is counted from the moment of the communication of the Jury decision to the interested parties and it is 48 hours.

The 24 hours of the day race do not count within the 48 hours to appeal.

Address, telephone and fax should be clearly mentioned on the appeal so that the UIM can send any correspondence directly to the driver with copy to his/her N.A. The driver may agree on having no International Court of Appeal meeting but to handle the appeal through telecommunication channels - if possible - in order to limit the costs of the appeal.

## 8. SAFETY

Before racing a craft with restraint system, all drivers must have passed an immersion test in a restraint system to ensure that they can exit a reinforced compartment successfully.

The immersion certificate should be provided by the National Authority of the driver and includes an immersion test in a simulated reinforced cockpit. The immersion test and the certificate must be renewed every 14 months.

A model for the certificate and instructions of how to perform an immersion test are available at the UIM Secretariat. All catamaran type hulls must have the deformable pickle forks according to rule 503.02.

Drivers must wear of flotation vest so constructed at the shoulders that a driver can be easily pulled of the cockpit.

Seats are mandatory for F1000 cockpits, per rule 509.08.

## 9. GENERAL

All TV, film, media and commercial rights are the property of the UIM.

If the UIM has a contracted promoter, he handles the rights on behalf of the UIM.

Any organisation wishing to film or to use existing film must contact the UIM or the promoter. Any correspondence regarding Formula 1000 must be sent to the following address:

UNION INTERNATIONALE MOTONAUTIQUE  
 STADE LOUIS II - ENTREE H  
 1 AVENUE DES CASTELANS  
 MC 98000 MONACO  
 Fax: (377) 92-05-04-60  
 E-mail: [uim@uim.sport](mailto:uim@uim.sport)  
 Website: [www.uim.sport](http://www.uim.sport)



# **CODE OF PRACTICE FOR MEDICAL & SAFETY F1 & F2 RACES**

**Published on 22/12/21**

## 1) RESCUE BOATS

Must be high speed, drop front boats which produce a minimum disturbance of the water.

There must be a minimum of two rescue boats along the circuit so placed that they can reach in the minimum possible time any point of the course. That is strictly recommended also for International Ordinary race in F2. Their locations and their co-ordination must be decided in a meeting among the O.O.D., the Medical Officer, the rescue Teams responsible and the UIM Commissioners before first practice.

These boats shall be equipped as a minimum as follows:

- a floating stretcher,
- belt cutters,
- one fire extinguisher,
- ropes (including tow ropes),
- an anchor,
- an haemostatic strip,
- bandages,
- a set of flags,
- red flares.

All these boats shall be in contact with each other, with the medical post and the O.O.D. with a radio equipment that has to be used without interfering with the driving and the rescue operations.

These boats shall not be allowed to carry on towing duties during the practice sessions and the race.

## 2) CREW MEMBERS

Each boat shall carry the following persons:

- an experienced driver,
- two crew members prepared and equipped to enter the water to support any injured driver and who are familiar with any safety equipment used on racing boats. All crew members should be familiar with handling injured persons according to the PHTLS (PreHospitalTraumaLifeSupport) concept or equal.

No Driver shall be pulled or assisted into any rescue boat; no Driver shall be removed from the water unless the hole body is supported by a stretcher. No other boat shall be allowed to pull or assist any injured driver.

## 3) MEDICAL ASSISTANCE

A minimum of three doctors are required at each event:

- The Medical Officer, a doctor well introduced in powerboat racing problems acting as the co-ordinator of the medical team;
- and the race;
- He shall carry on the boat all the equipment necessary for first aid assistance (a water sucker, intra tracheal tubes, Mayo cannulae, oxygen supply and do on).

## 4) GROUND ORGANISATION

Apart from the medical post reserved for the public each event must have a private post (minimum a tent) where an injured driver may be taken after initial resuscitation before being moved to the nearest hospital.

This medical post has to be located as close as possible to the rescue boat landing site. This has to be in a reserved area (not accessible to the public) and must be adequate for an easy and safe of the transfer operation injured driver. It is very important that the landing site and the medical post are located close to the race course even if far from the pits area. A nearby closed area for an helicopter is recommended.

A minimum of two ambulances is required. At least one of them must be equipped as a mobile resuscitation centre. They will be located close to the medical post and must have easy and constantly open access from the medical post to the road leading to the hospital.

A general hospital shall be informed about the Event and prepared to take care of an injured driver.

The Medical Officer, according to any specific situation, may ask the O.O.D. to adjust the rescue and medical organisation (increasing the number of rescue boats, ambulances and doctors) in order to maintain a minimum standard of assistance.

The presence and the employment of local teams able to work with the required equipment and efficiency are recommended.

## ELECTIONS OF THE DRIVERS' DELEGATE FOR F1, F2

The election must be held in the presence of a UIM official. The candidate must be a real driver (4 races or 40% of the total rounded up to the next unit); he is elected for a three year period provided he keeps within the limits of eligibility. The drivers' assembly may intervene if the delegate is not suitable any longer.

## ELECTIONS OF THE TEAMS' REPRESENTATIVE FOR F2 (CHAIRMAN OF F2 TEAM ASSOCIATION – F2TA)

The election must be held in the presence of a UIM commissioner. The candidate could be a person of a F.2 Team entered in the current World Championship or a person involved in F2 activity.

### 109.09 - MEDICAL EVALUATION SHEET

Location of test \_\_\_\_\_ Date \_\_\_\_\_

Name \_\_\_\_\_ Surname \_\_\_\_\_

Born in \_\_\_\_\_ Date \_\_\_\_\_

Address \_\_\_\_\_

Status \_\_\_\_\_ Profession \_\_\_\_\_

Date of first involvement in the sport \_\_\_\_\_

Other sports practised \_\_\_\_\_

#### PRESENT STATE OF HEALTH AND FORMER DISEASES

Disease (former or current) \_\_\_\_\_

With special mention of \_\_\_\_\_

Cardiopathy     Coronary     Diabetes Type 1 / 2 (circle the type)

Epilepsy     High blood pressure

Operations undergone previously \_\_\_\_\_

Dates of these operations \_\_\_\_\_

Accidents (when, where, under which circumstances) \_\_\_\_\_

\_\_\_\_\_

Alcohol g/day \_\_\_\_\_ Tobacco pack/year \_\_\_\_\_

Allergies \_\_\_\_\_



Medicines usually/frequently taken \_\_\_\_\_

Please keep in mind the Anti Doping rules and the WADA – UIM list of banned substances and Therapeutic Use Exemption rules.

### 109.10 - GENERAL OBJECTIVE EXAMINATION

Height m \_\_\_\_\_ Weight kg \_\_\_\_\_

(Exemption of BMI rule over 30 kg/m<sup>2</sup> : Please refer to the superlicence procedure posted on the UIM website)

Age \_\_\_\_\_ Sex \_\_\_\_\_

Congenital or acquired deformities \_\_\_\_\_

Respiratory system \_\_\_\_\_

Spirometry (mandatory) Please attach printed results and graphs \_\_\_\_\_

FVC (measured/predicted) \_\_\_\_\_

FEV<sub>1</sub> (measured/predicted) \_\_\_\_\_

Cardiovascular system : is there any evidence of abnormality of the heart or cardiovascular system ? o Yes o No  
If "Yes", give details below.

\_\_\_\_\_

Blood pressure at rest \_\_\_\_\_

Heart frequency at rest \_\_\_\_\_

Electrocardiogram at rest \_\_\_\_\_

Please attach printed results and graphs and final report in English language

\_\_\_\_\_

Ophthalmologic check-up (mandatory every other year)

Have you undergone this ophthalmologic check-up last year ?

If **yes**, please specify when : .. / .. / .....

If **not**, ask your ophthalmologist to fill the hereafter items

Faculty of vision (uncorrected) R \_\_\_\_\_ L \_\_\_\_\_

(with correction) R \_\_\_\_\_ L \_\_\_\_\_

Vision with both eyes open (wearing corrective lenses if necessary)

Field of vision \_\_\_\_\_

Vision of colours: is the applicant's colour vision normal?

o Yes o No

If "No", give details below.

\_\_\_\_\_

Signature and practice stamp of the ophthalmologist

Hearing testing \_\_\_\_\_

Urine: Albumine \_\_\_\_\_ Sugar \_\_\_\_\_

Is the Urine analysis normal? o Yes o No

If "No", give details below.

\_\_\_\_\_

Nervous system \_\_\_\_\_

Others \_\_\_\_\_

Does the applicant have any physical abnormality or restriction of movements in the arms or legs?  Yes  No  
If "Yes", give details below.

---

Is there any evidence of a physical or mental condition (past or present) which could, in your opinion, prevent the applicant from holding a competition licence for motorsport ?

Yes  No

If "Yes", give details below.

---

To the Doctor and the Driver :

Are you the applicant's usual doctor?  Yes  No

Your practice stamp (together with your name and qualifications):

Name in capital letters \_\_\_\_\_

Degree \_\_\_\_\_

Address \_\_\_\_\_

Tel \_\_\_\_\_

Fax \_\_\_\_\_

Aptitude assessment \_\_\_\_\_

Date \_\_\_\_\_

This is to certify that I have examined the applicant in line with this form.

Signature of the Doctor \_\_\_\_\_

Signature of the Driver \_\_\_\_\_

### 109.11 - ADDITIONAL ITEMS FOR SUPER-LICENCE

Maximal stress ECG and blood pressure profile: electrocardiogram have to be performed:

- \* on a cycloergometer starting at 60 or 70 watts and increasing by 30 or 35 watts every two minutes.

The driver must be capable of reaching a minimum power level of 2.5 watts (males) – 2.2 watts (females) per kilogram of body weight.

- \* or on a treadmill, using a Bruce protocol (preliminary warm-up recommended)

The driver must be capable to complete at least the entire stage 3 (i.e. 3 minutes at 5.5 km/h (3.4 mph) and 14% gradient).

© (2022) Copyright by UIM - Union Internationale Motonautique. All rights reserved. No part of this document/publication may be reproduced, distributed, or transmitted in any form or by any means without the prior written consent of the UIM, except for the non-commercial use within the scope of authority of the UIM and its affiliated members



1922 – 2022

# **CODE OF ETHICS 2022**

## TABLE OF CONTENTS

<b>CODE OF ETHICS</b> .....	<b>399</b>
<i>TABLE OF CONTENTS</i> .....	<i>400</i>
<b>1. PREAMBLE</b> .....	<b>401</b>
<b>THE ETHICAL PILLARS OF THE UIM</b> .....	<b>401</b>
<b>1.1 Equality</b> .....	<b>401</b>
<b>1.2 Fair Play</b> .....	<b>401</b>
<b>1.3 Respect</b> .....	<b>401</b>
<b>1.4 Integrity</b> .....	<b>402</b>
<b>1.5 Environment</b> .....	<b>403</b>
<b>2. GENERAL CONDUCT REGULATIONS</b> .....	<b>403</b>
<b>2.1 Basic rules</b> .....	<b>403</b>
<b>2.2 Representational duties</b> .....	<b>403</b>
<b>2.3 Conduct towards government and private organizations</b> .....	<b>403</b>
<b>2.4 Ban on discrimination</b> .....	<b>403</b>
<b>2.5 Eligibility and dismissal</b> .....	<b>404</b>
<b>2.6 Protection of personal rights</b> .....	<b>404</b>
<b>2.7 Loyalty and confidentiality</b> .....	<b>404</b>
<b>3. PROCEEDINGS</b> .....	<b>404</b>
<b>4. ENFORCEMENT</b> .....	<b>405</b>

## 1. PREAMBLE

The UIM is committed to the highest standards of conduct in sport *Administration* and *Competition*. To meet this commitment, the UIM has developed a *Code of Ethics* to express the core values of both the organization and the sport of Powerboating. Such values and ethics underpin the UIM's policies, procedures and rules. Observance of the *Code* is vital to the integrity of Powerboating. The UIM *Code of Ethics* is inspired to the ethical principles of the Olympic Movement of which the UIM is member.

The UIM *Code of Ethics* comprises five pillars. It imposes obligations in terms of respect and responsibility to competitors, teams, promoters, participants and all other UIM accredited *Persons*.

This *Code* shall apply to all UIM members (either national federation or any other similar affiliated entity), UIM staff, *Persons* elected or appointed to any position within the organization of the UIM or the Continental Organizations, and other individuals engaged in UIM activities, including *Drivers*, competitors, team managers, team members etc. (collectively referred to herein as "Participants"). It shall also apply to consultants and contractually-connected *Persons/firms*, including those representing or serving UIM.

Unless otherwise specified, infringements are punishable regardless of whether they have been committed deliberately or negligently.

Acts amounting to attempted infringements are also punishable. In the case of acts amounting to attempted infringements, the Executive Committee may reduce the sanction envisaged for the actual infringement accordingly. It will determine the extent of the mitigation as it sees fit; it shall not go below the general lower limit of the fine applicable to the concerned infringement.

The fact that a natural *Person* is not anymore a member of the UIM or has left a member of the UIM neither cancel out liability nor prevents from carrying out disciplinary proceedings. The same provision applies to legal *Persons* members of the UIM.

## THE ETHICAL PILLARS OF THE UIM

### 1.1 Equality

Discrimination and harassment against others on grounds of race, disability, marital status, sex, sexuality, age, political or religious conviction are not condoned in Powerboating.

All forms of harassment, be they physical, mental, professional or sexual, are strictly prohibited.

Powerboating promotes the inclusion of men and women equally.

### 1.2 Fair Play

Fair play is the guiding principle in the sport of Powerboating. All Participants taking part in Powerboating shall behave with fairness and honesty.

All Participants shall operate within and abide by the rules of the sport.

All doping practices at all levels are strictly prohibited. The provisions against doping in the *Anti-Doping Code* shall be scrupulously observed. Powerboating is committed to be a drug free sport.

### 1.3 Respect

Powerboating shall be characterized by mutual respect and self-responsibility. All Participants involved in powerboating shall be treated with dignity.

The contribution that people make to the sport shall be recognised.

In pursuing the sport's goals, the governance of Powerboating shall be mindful of the physical and psychological well-being of its members.

Violence and abusive behaviour are not tolerated.

## 1.4 Integrity

All *Persons* subject to this *Code* shall *Use* due care and diligence in fulfilling their roles for, and on behalf of, the UIM or Powerboating in general.

Decisions by the UIM will be made in accordance with established procedures, objectively, fairly and with honesty and integrity.

Conflicts of interest must be avoided.

### 1.4.1 Conflicts of interest

In discharging their duties to UIM, all *Participants* shall act for the benefit of UIM when making decisions that affect, or may affect, UIM and to do so without reference to their own personal interests, either financial or otherwise.

When performing an activity for UIM or before being elected or appointed, the candidate or *Participant* shall disclose to the Executive Committee any personal interests that could be linked with their prospective UIM activities. The Executive Committee may draw the attention of the candidate or *Participant* to potential conflicts of interest that it identifies.

*Participants* shall avoid any situation that could lead to conflicts of interest. Potential conflicts of interest arise:

- if *Participants* have, or appear to have, private or personal interests that detract from their ability to perform their duties with integrity in an independent and purposeful manner. Private or personal interests include gaining any possible advantage for the *Persons* bound by this *Code* themselves, their family, relatives, friends and acquaintances;
- if the opinion or decision of an *Official*, acting alone or within an organisation, is influenced by, or may be reasonably considered as liable to be influenced by relations that such *Official* has, has had or is on the point of having, with another *Person* or organisation that would be affected by the *Person's* opinion or decision;
- if an *Official* is also involved in the executive day to day running of Continental/*National* federations of powerboating sports.

In the following non-exhaustive list of examples, the circumstances in which a conflict of interests could arise are personal and/or material involvement (salary, shareholding, various benefits) with:

- suppliers of the party concerned;
- sponsors, broadcasters, various contracting parties;
- organisations liable to benefit from the assistance of the party concerned (including subsidy, approval clause or election).

*Participants* shall not perform their duties in matters with an existing or potential conflict of interest. Should a conflict of interest, or the appearance of a conflict of interest, arise, or if there is a danger of such conflict arising, the individual concerned must refrain from taking any further part in the handling of the matter. If it is unclear whether such a conflict of interest exists in any given situation, the matter may be submitted to the Ethics Panel.

If an objection is made concerning an existing or potential conflict of interest of a *Participant*, it shall be reported immediately to the Ethics Panel for appropriate measures.

If an *Official* neglects to declare a situation of a potential conflict of interest, any interested party in the UIM may refer the matter to the Executive Committee. When such a situation regards the President or any member of the Executive Committee, the member concerned shall abstain from taking part in the meetings of the Executive Committee where his position is to be adjudged, without prejudice of his right of defence.

### 1.4.2 Corruption

No *Participant* shall, directly or indirectly, solicit, accept or offer any concealed remuneration, commission, gifts, benefit or service of any nature connected with their participation in powerboating activities or with their function as an *Official*.

No *Participant* shall, directly or indirectly bribe or *Attempt* to bribe third parties or urge or incite others to do so in order to gain an advantage for them or a third party.

No *Participant* shall solicit or accept benefits, entertainment or gifts in exchange for, or as a condition of, the exercise of their duties, or as an inducement for performing an act associated with their duties or responsibilities, except that gifts, hospitality or other benefits associated with their official duties and responsibilities may be accepted if such gifts, hospitality or other benefits:

- a) are within the bounds of propriety, a normal expression of courtesy, or within the normal standards of hospitality;
- b) would not bring suspicion on the Official's objectivity and impartiality; and
- c) would not compromise the integrity of UIM.

No *Participant* may be involved with any company, association, firm or *Person* whose activity is inconsistent with the objectives or interests of UIM. If it is unclear, whether this kind of a connection exists in any given situation, the matter shall be submitted to the Executive Committee for a decision.

### 1.4.3 Betting

Anyone subject to this *Code* shall not bet on Powerboating either directly or indirectly and shall not *Use* any privileged, sensitive or inside information they may have in order to profit or facilitate third *Persons* to profit from such information.

Anyone subject to this *Code* shall not perform corrupt practices relating to the sport of Powerboating, including improperly influencing either the course of an *Event* (partially or entirely) or the outcomes and results of an *Event* or race.

Anyone subject to this *Code* is forbidden from having stakes, either actively or passively, in any entity or organization that promotes, brokers, arranges or conducts such activities or transactions.

Anyone subject to this *Code* shall exercise due care and diligence in fulfilling their roles for, or on behalf of UIM and not disclose information received if such disclosure is made maliciously in order to damage the interests of UIM or to obtain an unjust advantage or profit.

No UIM staff, governance bodies and other committee or commission member shall make adverse comments on a policy adopted by the UIM once the UIM decision has been taken.

### 1.5 Environment

The UIM is committed to raise environmental performance of power boating and make our sport a vector of environmental protection and sustainable development.

UIM looks to youth to breed a future for sportsmanship and safety while nurturing a passion and respect for water and its environment.

The UIM will promote the optimal *Use* of resources and materials, efficient logistics and transport, reduction of polluting discharges to water and emissions to air.

## 2. GENERAL CONDUCT REGULATIONS

### 2.1 Basic rules

All Participants shall show commitment to an ethical attitude while fulfilling their task. They shall pledge to behave in accordance with the ethical pillars of the UIM.

Participants may not abuse their position as part of their function in any way, especially to take advantage of their function for private aims or gains.

### 2.2 Representational duties

Participants shall represent UIM honestly, respectably and with integrity.

### 2.3 Conduct towards government and private organizations

In dealings with government institutions, national and International organizations, associations and groupings, Participants shall, in addition to observing the basic rules of art.2.1, remain politically neutral, in accordance with the principles and objectives of UIM and act in a manner compatible with their function and integrity.

### 2.4 Ban on discrimination

Participants may not act in a discriminatory manner, especially with regard to ethnicity, race, culture, politics, religion, gender or language.

## 2.5 Eligibility and dismissal

Only those *Persons* who demonstrate a high degree of ethics and integrity and pledge to observe the provisions of this *Code* without reservation are eligible to serve as UIM officials. Anyone who do not comply with these conditions are either no longer eligible or shall be removed from office.

## 2.6 Protection of personal rights

During the course of their activities, Participants shall ensure that the personal rights of those *Persons* whom they contact and with whom they deal are protected, respected and safeguarded.

## 2.7 Loyalty and confidentiality

While performing their duties, participants shall remain loyal to UIM Depending on their function, any information divulged to officials during the course of their duties shall be treated as confidential. Any information or opinions shall be passed on in accordance with the principles and objectives of UIM.

## 3. PROCEEDINGS

The UIM Executive Committee shall have exclusive jurisdiction on any infringement of the rules contemplated in this *Code*. Anyone who has interest can refer to the UIM Executive Committee the infringement of this *Code* of Ethics. Proceedings before the UIM Executive Committee shall be without particular formalities, provided that the right of defence and the principles of fair process are always respected.

The UIM Executive Committee appoints an investigator, who may, but not necessarily has to a member of the Executive Committee. The Investigator shall investigate the case and deliver to the UIM Executive Committee a written report. Such report shall be sent to the party or the parties concerned, with an invitation to submit defensive briefs and appear before the Executive Committee at the discussion hearing.

At the discussion hearing parties may be assisted by an attorney. The Executive Committee members and the appointed Investigator may attend the hearing also by video or tele-conference.

The infringements of the rules of this *Code* shall be sanctioned as follows:

- i) First violation, up to six months suspension and up to Euro 5,000 fine;
- ii) Second violation, from six months up to two years suspension and from Euro 5,000 up to Euro 10,000 fine;
- iii) Third violation, life ban and Euro 15,000 fine;
- iv) Highly serious infringements shall be sanctioned with no less than a two years suspension and then Euro 15,000 fine.

Should the infringement be committed by a consultant or any other contracted party of the UIM, the relevant contract shall be immediately terminated de iure.

Should the infringement be committed to obtain an illicit benefit, including sport outcomes, the relevant results, such as titles, prizes etc. shall not be awarded or revoked if already awarded.

The Executive Committee may reduce the sanctions envisaged for each actual infringement in



accordance with the extent of the mitigation as it sees fit. In any *Event* the sanction shall not go below the general lower limit of the fine applicable to the concerned infringement.

The parties to the proceedings shall keep strictly confidential and shall not disclose any information received or appraised during the proceedings. The decision taken by the UIM Executive Committee shall be published on the UIM website. The sanctioned party shall have 21 days as of the publication of the decision on the UIM website to appeal the decision before the Court of Arbitration for Sport in Lausanne.

#### **4. ENFORCEMENT**

This *Code* of Ethics is an integral and binding part of the UIM By-Laws and has entered into force and is fully effective since approval by the General Assembly on 26<sup>th</sup> October 2014.



1922 – 2022

# **ANTI-DOPING RULES 2022**

## TABLE OF CONTENTS

<b><u>INTRODUCTION</u></b> .....	408
<b><u>ARTICLE 1</u></b> <b><u>DEFINITION OF DOPING</u></b> .....	410
<b><u>ARTICLE 2</u></b> <b><u>ANTI-DOPING RULE VIOLATIONS</u></b> .....	410
<b><u>ARTICLE 3</u></b> <b><u>PROOF OF DOPING</u></b> .....	413
<b><u>ARTICLE 4</u></b> <b><u>THE PROHIBITED LIST</u></b> .....	416
<b><u>ARTICLE 5</u></b> <b><u>TESTING AND INVESTIGATIONS</u></b> .....	420
<b><u>ARTICLE 6</u></b> <b><u>ANALYSIS OF SAMPLES</u></b> .....	424
<b><u>ARTICLE 7</u></b> <b><u>RESULTS MANAGEMENT: RESPONSIBILITY, INITIAL REVIEW, NOTICE AND PROVISIONAL SUSPENSIONS</u></b> .....	426
<b><u>ARTICLE 8</u></b> <b><u>RESULTS MANAGEMENT: RIGHT TO A FAIR HEARING AND NOTICE OF HEARING DECISION</u></b> .....	429
<b><u>ARTICLE 9</u></b> <b><u>AUTOMATIC DISQUALIFICATION OF INDIVIDUAL RESULTS</u></b> .....	431
<b><u>ARTICLE 10</u></b> <b><u>SANCTIONS ON INDIVIDUALS</u></b> .....	431
<b><u>ARTICLE 11</u></b> <b><u>CONSEQUENCES TO TEAMS</u></b> .....	443
<b><u>ARTICLE 12</u></b> <b><u>SANCTIONS BY THE UIM AGAINST OTHER SPORTING BODIES</u></b> .....	443
<b><u>ARTICLE 13</u></b> <b><u>RESULTS MANAGEMENT: APPEALS</u></b> .....	444
<b><u>ARTICLE 14</u></b> <b><u>CONFIDENTIALITY AND REPORTING</u></b> .....	448
<b><u>ARTICLE 15</u></b> <b><u>IMPLEMENTATION OF DECISIONS</u></b> .....	452
<b><u>ARTICLE 16</u></b> <b><u>STATUTE OF LIMITATIONS</u></b> .....	453
<b><u>ARTICLE 17</u></b> <b><u>EDUCATION</u></b> .....	453
<b><u>ARTICLE 18</u></b> <b><u>ADDITIONAL ROLES AND RESPONSIBILITIES OF NATIONAL AUTHORITIES</u></b> .....	454
<b><u>ARTICLE 19</u></b> <b><u>ADDITIONAL ROLES AND RESPONSIBILITIES OF THE UIM</u></b> .....	455
<b><u>ARTICLE 20</u></b> <b><u>ADDITIONAL ROLES AND RESPONSIBILITIES OF ATHLETES</u></b> .....	455
<b><u>ARTICLE 21</u></b> <b><u>ADDITIONAL ROLES AND RESPONSIBILITIES OF ATHLETE SUPPORT PERSONNEL</u></b> .....	456
<b><u>ARTICLE 22</u></b> <b><u>ADDITIONAL ROLES AND RESPONSIBILITIES OF OTHER PERSONS SUBJECT TO THESE ANTI-DOPING RULES</u></b> .....	456
<b><u>ARTICLE 23</u></b> <b><u>INTERPRETATION OF THE CODE</u></b> .....	457
<b><u>ARTICLE 24</u></b> <b><u>FINAL PROVISIONS</u></b> .....	457
<b><u>APPENDIX 1</u></b> <b><u>DEFINITIONS</u></b> .....	459

## THE UIM ANTI-DOPING RULES

### INTRODUCTION

#### Preface

These Anti-Doping Rules are adopted and implemented in accordance with the UIM's responsibilities under the *Code*, and in furtherance of the UIM's continuing efforts to eradicate doping in sport.

These Anti-Doping Rules are sport rules governing the conditions under which sport is played. Aimed at enforcing anti-doping rules in a global and harmonized manner, they are distinct in nature from criminal and civil laws. They are not intended to be subject to or limited by any national requirements and legal standards applicable to criminal or civil proceedings, although they are intended to be applied in a manner which respects the principles of proportionality and human rights. When reviewing the facts and the law of a given case, all courts, arbitral tribunals and other adjudicating bodies should be aware of and respect the distinct nature of these Anti-Doping Rules, which implement the *Code*, and the fact that these rules represent the consensus of a broad spectrum of stakeholders around the world as to what is necessary to protect and ensure fair sport.

As provided in the *Code*, the UIM shall be responsible for conducting all aspects of *Doping Control*. Any aspect of *Doping Control* or anti-doping *Education* may be delegated by the UIM to a *Delegated Third Party*, such as the International Testing Agency (ITA), however, the UIM shall require the *Delegated Third Party* to perform such aspects in compliance with the *Code*, *International Standards*, and these Anti-Doping Rules. The UIM may delegate its adjudication responsibilities and *Results Management* to the CAS Anti-Doping Division.

When the UIM has delegated its responsibilities to implement part or all of *Doping Control* to the ITA or to any other *Delegated Third Party*, any reference to the UIM in these *Rules* should be intended as a reference to the ITA or to the other *Delegated Third Party*, where applicable and within the context of the aforementioned delegation. The UIM shall always remain fully responsible for ensuring that any delegated aspects are performed in compliance with the *Code*.

Italicized terms in these Anti-Doping Rules are defined terms in Appendix 1.

Unless otherwise specified, references to Articles are references to Articles of these Anti-Doping Rules.

#### Fundamental Rationale for the *Code* and the UIM's Anti-Doping Rules

Anti-doping programs are founded on the intrinsic value of sport. This intrinsic value is often referred to as "the spirit of sport": the ethical pursuit of human excellence through the dedicated perfection of each *Athlete's* natural talents.

Anti-doping programs seek to protect the health of *Athletes* and to provide the opportunity for *Athletes* to pursue human excellence without the *Use of Prohibited Substances and Methods*.

Anti-doping programs seek to maintain the integrity of sport in terms of respect for rules, other competitors, fair competition, a level playing field, and the value of clean sport to the world.

The spirit of sport is the celebration of the human spirit, body and mind. It is the essence of Olympism and is reflected in the values we find in and through sport, including:

- Health
- Ethics, fair play and honesty
- *Athletes'* rights as set forth in the *Code*
- Excellence in performance
- Character and *Education*
- Fun and joy
- Teamwork
- Dedication and commitment

- Respect for rules and laws
- Respect for self and other *Participants*
- Courage
- Community and solidarity

The spirit of sport is expressed in how we play true.

Doping is fundamentally contrary to the spirit of sport.

### Scope of these Anti-Doping Rules

These Anti-Doping Rules shall apply to:

- (a) the UIM, including its board members, directors, officers and specified employees, and *Delegated Third Parties* and their employees, who are involved in any aspect of *Doping Control*;
- (b) each of its *National Authorities*, including their board members, directors, officers and specified employees, and *Delegated Third Parties* and their employees, who are involved in any aspect of *Doping Control*;
- (c) the following *Athletes*, *Athlete Support Personnel* and other *Persons*:
  - (i) all *Athletes* and *Athlete Support Personnel* who are members of the UIM, or of any *National Authority*, or of any member or affiliate organization of any *National Authority* (including any clubs, teams, associations, or leagues);
  - (ii) all *Athletes* and *Athlete Support Personnel* who participate in such capacity in *Events*, *Competitions* and other activities organized, convened, authorized or recognized by the UIM, or any *National Authority*, or by any member or affiliate organization of any *National Authority* (including any clubs, teams, associations, or leagues), wherever held;
  - (iii) any other *Athlete* or *Athlete Support Personnel* or other *Person* who, by virtue of an accreditation, a license or other contractual arrangement, or otherwise, is subject to the authority of the UIM, or of any *National Authority*, or of any member or affiliate organization of any *National Authority* (including any clubs, teams, associations, or leagues), for purposes of anti-doping; and
  - (iv) *Athletes* who are not regular members of the UIM or of one of its *National Authorities* but who want to be eligible to compete in a particular *International Event*.

Each of the abovementioned *Persons* is deemed, as a condition of his or her participation or involvement in the sport, to have agreed to and be bound by these Anti-Doping Rules, and to have submitted to the authority of the UIM to enforce these Anti-Doping Rules, including any *Consequences* for the breach thereof, and to the jurisdiction of the hearing panels specified in Article 8 and Article 13 to hear and determine cases and appeals brought under these Anti-Doping Rules.<sup>1</sup>

Within the overall pool of *Athletes* set out above who are bound by and required to comply with these Anti-Doping Rules, the following *Athletes* shall be considered to be *International-Level Athletes* for the purposes of these Anti-Doping Rules, and, therefore, the specific provisions in these Anti-Doping Rules applicable to *International-Level Athletes* (e.g., *Testing*, *TUEs*, whereabouts, and *Results Management*) shall apply to such *Athletes*:

<sup>1</sup> [Comment: Where the Code requires a Person other than an Athlete or Athlete Support Person to be bound by the Code, such Person would of course not be subject to Sample collection or Testing, and would not be charged with an anti-doping rule violation under the Code for Use or Possession of a Prohibited Substance or Prohibited Method. Rather, such Person would only be subject to discipline for a violation of Code Articles 2.5 (Tampering), 2.7 (Trafficking), 2.8 (Administration), 2.9 (Complicity), 2.10 (Prohibited Association) and 2.11 (Retaliation). Furthermore, such Person would be subject to the additional roles and responsibilities according to Code Article 21.3. Also, the obligation to require an employee to be bound by the Code is subject to applicable law.]

*The UIM shall ensure that, as per Article 19 of these Anti-Doping Rules, any arrangements with their board members, directors, officers, and specified employees, as well as with the Delegated Third Parties and their employees – either employment, contractual or otherwise – have explicit provisions incorporated according to which such Persons are bound by, agree to comply with these Anti-Doping Rules, and agree on the the UIM's authority to solve the anti-doping cases.]*

- (a) *Athletes* who hold the following license: UIM Superlicence, UIM Serieslicence;
- (b) *Athletes* who compete in any of the following *International Events*: UIM World Championship or Cup, UIM Continental Championships,
- (c) *Athletes* included in the UIM *Registered Testing Pool*, *Testing Pool* and any other Pool established by UIM;

## ARTICLE 1 DEFINITION OF DOPING

Doping is defined as the occurrence of one or more of the anti-doping rule violations set forth in Article 2.1 through Article 2.11 of these Anti-Doping Rules.

## ARTICLE 2 ANTI-DOPING RULE VIOLATIONS

The purpose of Article 2 is to specify the circumstances and conduct which constitute anti-doping rule violations. Hearings in doping cases will proceed based on the assertion that one or more of these specific rules have been violated.

*Athletes* or other *Persons* shall be responsible for knowing what constitutes an anti-doping rule violation and the substances and methods which have been included on the *Prohibited List*.

The following constitute anti-doping rule violations:

### 2.1 Presence of a Prohibited Substance or its Metabolites or Markers in an Athlete's Sample

- 2.1.1 It is the *Athletes'* personal duty to ensure that no *Prohibited Substance* enters their bodies. *Athletes* are responsible for any *Prohibited Substance* or its *Metabolites* or *Markers* found to be present in their *Samples*. Accordingly, it is not necessary that intent, *Fault*, *Negligence* or knowing *Use* on the *Athlete's* part be demonstrated in order to establish an anti-doping rule violation under Article 2.1.<sup>2</sup>
- 2.1.2 Sufficient proof of an anti-doping rule violation under Article 2.1 is established by any of the following: presence of a *Prohibited Substance* or its *Metabolites* or *Markers* in the *Athlete's* A *Sample* where the *Athlete* waives analysis of the B *Sample* and the B *Sample* is not analyzed; or, where the *Athlete's* B *Sample* is analyzed and the analysis of the *Athlete's* B *Sample* confirms the presence of the *Prohibited Substance* or its *Metabolites* or *Markers* found in the *Athlete's* A *Sample*; or where the *Athlete's* A or B *Sample* is split into two (2) parts and the analysis of the confirmation part of the split *Sample* confirms the presence of the *Prohibited Substance* or its *Metabolites* or *Markers* found in the first part of the split *Sample* or the *Athlete* waives analysis of the confirmation part of the split *Sample*.<sup>3</sup>
- 2.1.3 Excepting those substances for which a *Decision Limit* is specifically identified in the *Prohibited List* or a *Technical Document*, the presence of any

<sup>2</sup> [Comment to Article 2.1.1: An anti-doping rule violation is committed under this Article without regard to an *Athlete's* *Fault*. This rule has been referred to in various CAS decisions as "Strict Liability". An *Athlete's* *Fault* is taken into consideration in determining the Consequences of this anti-doping rule violation under Article 10. This principle has consistently been upheld by CAS.]

<sup>3</sup> [Comment to Article 2.1.2: The Anti-Doping Organization with Results Management responsibility may, at its discretion, choose to have the B *Sample* analyzed even if the *Athlete* does not request the analysis of the B *Sample*.]

reported quantity of a *Prohibited Substance* or its *Metabolites* or *Markers* in an *Athlete's Sample* shall constitute an anti-doping rule violation.

- 2.1.4** As an exception to the general rule of Article 2.1, the *Prohibited List*, *International Standards* or *Technical Documents* may establish special criteria for reporting or the evaluation of certain *Prohibited Substances*.

## **2.2 Use or Attempted Use by an Athlete of a Prohibited Substance or a Prohibited Method<sup>4</sup>**

- 2.2.1** It is the *Athletes'* personal duty to ensure that no *Prohibited Substance* enters their bodies and that no *Prohibited Method* is *Used*. Accordingly, it is not necessary that intent, *Fault*, *Negligence* or knowing *Use* on the *Athlete's* part be demonstrated in order to establish an anti-doping rule violation for *Use* of a *Prohibited Substance* or a *Prohibited Method*.

- 2.2.2** The success or failure of the *Use* or *Attempted Use* of a *Prohibited Substance* or *Prohibited Method* is not material. It is sufficient that the *Prohibited Substance* or *Prohibited Method* was *Used* or *Attempted* to be *Used* for an anti-doping rule violation to be committed.<sup>5</sup>

## **2.3 Evading, Refusing or Failing to Submit to Sample Collection by an Athlete**

Evading *Sample* collection; or refusing or failing to submit to *Sample* collection without compelling justification after notification by a duly authorized *Person*.<sup>6</sup>

## **2.4 Whereabouts Failures by an Athlete**

Any combination of three (3) missed tests and/or filing failures, as defined in the *International Standard for Results Management*, within a twelve (12) month period by an *Athlete* in a *Registered Testing Pool*.

## **2.5 Tampering or Attempted Tampering with any Part of Doping Control by an Athlete or Other Person**

## **2.6 Possession of a Prohibited Substance or a Prohibited Method by an Athlete or Athlete Support Person**

- 2.6.1** *Possession* by an *Athlete In-Competition* of any *Prohibited Substance* or any *Prohibited Method*, or *Possession* by an *Athlete Out-of-Competition* of any *Prohibited Substance* or any *Prohibited Method* which is prohibited *Out-of-*

<sup>4</sup> [Comment to Article 2.2: It has always been the case that *Use* or *Attempted Use* of a *Prohibited Substance* or *Prohibited Method* may be established by any reliable means. As noted in the Comment to Article 3.2, unlike the proof required to establish an anti-doping rule violation under Article 2.1, *Use* or *Attempted Use* may also be established by other reliable means such as admissions by the *Athlete*, witness statements, documentary evidence, conclusions drawn from longitudinal profiling, including data collected as part of the *Athlete Biological Passport*, or other analytical information which does not otherwise satisfy all the requirements to establish "Presence" of a *Prohibited Substance* under Article 2.1.

For example, *Use* may be established based upon reliable analytical data from the analysis of an *A Sample* (without confirmation from an analysis of a *B Sample*) or from the analysis of a *B Sample* alone where the *Anti-Doping Organization* provides a satisfactory explanation for the lack of confirmation in the other *Sample*.]

<sup>5</sup> [Comment to Article 2.2.2: Demonstrating the "Attempted Use" of a *Prohibited Substance* or a *Prohibited Method* requires proof of intent on the *Athlete's* part. The fact that intent may be required to prove this particular anti-doping rule violation does not undermine the *Strict Liability* principle established for violations of Article 2.1 and violations of Article 2.2 in respect of *Use* of a *Prohibited Substance* or *Prohibited Method*.

An *Athlete's Use* of a *Prohibited Substance* constitutes an anti-doping rule violation unless such substance is not prohibited *Out-of-Competition* and the *Athlete's Use* takes place *Out-of-Competition*. (However, the presence of a *Prohibited Substance* or its *Metabolites* or *Markers* in a *Sample* collected *In-Competition* is a violation of Article 2.1 regardless of when that substance might have been administered.)]

<sup>6</sup> [Comment to Article 2.3: For example, it would be an anti-doping rule violation of "evading *Sample* collection" if it were established that an *Athlete* was deliberately avoiding a *Doping Control* official to evade notification or *Testing*. A violation of "failing to submit to *Sample* collection" may be based on either intentional or negligent conduct of the *Athlete*, while "evading" or "refusing" *Sample* collection contemplates intentional conduct by the *Athlete*.]

Competition unless the Athlete establishes that the Possession is consistent with a Therapeutic Use Exemption ("TUE") granted in accordance with Article 4.4 or other acceptable justification.

- 2.6.2** Possession by an Athlete Support Person In-Competition of any Prohibited Substance or any Prohibited Method, or Possession by an Athlete Support Person Out-of-Competition of any Prohibited Substance or any Prohibited Method which is prohibited Out-of-Competition in connection with an Athlete, Competition or training, unless the Athlete Support Person establishes that the Possession is consistent with a TUE granted to an Athlete in accordance with Article 4.4 or other acceptable justification.<sup>7</sup>

## **2.7 Trafficking or Attempted Trafficking in any Prohibited Substance or Prohibited Method by an Athlete or Other Person**

### **2.8 Administration or Attempted Administration by an Athlete or Other Person to any Athlete In-Competition of any Prohibited Substance or Prohibited Method, or Administration or Attempted Administration to any Athlete Out-of-Competition of any Prohibited Substance or any Prohibited Method that is Prohibited Out-of-Competition**

## **2.9 Complicity or Attempted Complicity by an Athlete or Other Person**

Assisting, encouraging, aiding, abetting, conspiring, covering up or any other type of intentional complicity or Attempted complicity involving an anti-doping rule violation, Attempted anti-doping rule violation or violation of Article 10.14.1 by another Person.<sup>8</sup>

## **2.10 Prohibited Association by an Athlete or Other Person**

- 2.10.1** Association by an Athlete or other Person subject to the authority of an Anti-Doping Organization in a professional or sport-related capacity with any Athlete Support Person who:
- 2.10.1.1** If subject to the authority of an Anti-Doping Organization, is serving a period of Ineligibility; or
  - 2.10.1.2** If not subject to the authority of an Anti-Doping Organization and where Ineligibility has not been addressed in a Results Management process pursuant to the Code, has been convicted or found in a criminal, disciplinary or professional proceeding to have engaged in conduct which would have constituted a violation of anti-doping rules if Code-compliant rules had been applicable to such Person. The disqualifying status of such Person shall be in force for the longer of six (6) years from the criminal, professional or disciplinary decision or the duration of the criminal, disciplinary or professional sanction imposed; or
  - 2.10.1.3** Is serving as a front or intermediary for an individual described in Article 2.10.1.1 or 2.10.1.2.
- 2.10.2** To establish a violation of Article 2.10, an Anti-Doping Organization must establish that the Athlete or other Person knew of the Athlete Support Person's disqualifying status.

<sup>7</sup> [Comment to Articles 2.6.1 and 2.6.2: Acceptable justification would not include, for example, buying or Possessing a Prohibited Substance for purposes of giving it to a friend or relative, except under justifiable medical circumstances where that Person had a physician's prescription, e.g., buying Insulin for a diabetic child.]

[Comment to Article 2.6.1 and 2.6.2: Acceptable justification may include, for example, (a) an Athlete or a team doctor carrying Prohibited Substances or Prohibited Methods for dealing with acute and emergency situations (e.g., an epinephrine auto-injector), or (b) an Athlete Possessing a Prohibited Substance or Prohibited Method for therapeutic reasons shortly prior to applying for and receiving a determination on a TUE.]

<sup>8</sup> [Comment to Article 2.9: Complicity or Attempted Complicity may include either physical or psychological assistance.]



The burden shall be on the *Athlete* or other *Person* to establish that any association with an *Athlete Support Person* described in Article 2.10.1.1 or 2.10.1.2 is not in a professional or sport-related capacity and/or that such association could not have been reasonably avoided.

*Anti-Doping Organizations* that are aware of *Athlete Support Personnel* who meet the criteria described in Article 2.10.1.1, 2.10.1.2, or 2.10.1.3 shall submit that information to WADA.<sup>9</sup>

### **2.11 Acts by an Athlete or Other Person to Discourage or Retaliate Against Reporting to Authorities**

Where such conduct does not otherwise constitute a violation of Article 2.5:

- 2.11.1** Any act which threatens or seeks to intimidate another *Person* with the intent of discouraging the *Person* from the good-faith reporting of information that relates to an alleged anti-doping rule violation or alleged non-compliance with the *Code to WADA*, an *Anti-Doping Organization*, law enforcement, regulatory or professional disciplinary body, hearing body or *Person* conducting an investigation for WADA or an *Anti-Doping Organization*.
- 2.11.2** Retaliation against a *Person* who, in good faith, has provided evidence or information that relates to an alleged anti-doping rule violation or alleged non-compliance with the *Code to WADA*, an *Anti-Doping Organization*, law enforcement, regulatory or professional disciplinary body, hearing body or *Person* conducting an investigation for WADA or an *Anti-Doping Organization*.

For purposes of Article 2.11, retaliation, threatening and intimidation include an act taken against such *Person* either because the act lacks a good faith basis or is a disproportionate response.<sup>10</sup>

## **ARTICLE 3 PROOF OF DOPING**

### **3.1 Burdens and Standards of Proof**

The UIM shall have the burden of establishing that an anti-doping rule violation has occurred. The standard of proof shall be whether the UIM has established an anti-doping rule violation to the comfortable satisfaction of the hearing panel bearing in mind the seriousness of the allegation which is made. This standard of proof in all cases is greater than a mere balance of

<sup>9</sup> [Comment to Article 2.10: Athletes and other Persons must not work with coaches, trainers, physicians or other Athlete Support Personnel who are Ineligible on account of an anti-doping rule violation or who have been criminally convicted or professionally disciplined in relation to doping. This also prohibits association with any other Athlete who is acting as a coach or Athlete Support Person while serving a period of Ineligibility. Some examples of the types of association which are prohibited include: obtaining training, strategy, technique, nutrition or medical advice; obtaining therapy, treatment or prescriptions; providing any bodily products for analysis; or allowing the Athlete Support Person to serve as an agent or representative. Prohibited association need not involve any form of compensation.]

While Article 2.10 does not require the Anti-Doping Organization to notify the Athlete or other Person about the Athlete Support Person's disqualifying status, such notice, if provided, would be important evidence to establish that the Athlete or other Person knew about the disqualifying status of the Athlete Support Person.]

<sup>10</sup> [Comment to Article 2.11.2: This Article is intended to protect Persons who make good faith reports, and does not protect Persons who knowingly make false reports.]

[Comment to Article 2.11.2: Retaliation would include, for example, actions that threaten the physical or mental well-being or economic interests of the reporting Persons, their families or associates. Retaliation would not include an Anti-Doping Organization asserting in good faith an anti-doping rule violation against the reporting Person. For purposes of Article 2.11, a report is not made in good faith where the Person making the report knows the report to be false.]

probability but less than proof beyond a reasonable doubt. Where these Anti-Doping Rules place the burden of proof upon the *Athlete* or other *Person* alleged to have committed an anti-doping rule violation to rebut a presumption or establish specified facts or circumstances, except as provided in Articles 3.2.2 and 3.2.3, the standard of proof shall be by a balance of probability.<sup>11</sup>

### **3.2 Methods of Establishing Facts and Presumptions**

Facts related to anti-doping rule violations may be established by any reliable means, including admissions.<sup>12</sup> The following rules of proof shall be applicable in doping cases:

**3.2.1** Analytical methods or *Decision Limits* approved by WADA after consultation within the relevant scientific community or which have been the subject of peer review are presumed to be scientifically valid. Any *Athlete* or other *Person* seeking to challenge whether the conditions for such presumption have been met or to rebut this presumption of scientific validity shall, as a condition precedent to any such challenge, first notify WADA of the challenge and the basis of the challenge. The initial hearing body, appellate body or CAS, on its own initiative, may also inform WADA of any such challenge. Within ten (10) days of WADA's receipt of such notice and the case file related to such challenge, WADA shall also have the right to intervene as a party, appear as amicus curiae or otherwise provide evidence in such proceeding. In cases before CAS, at WADA's request, the CAS panel shall appoint an appropriate scientific expert to assist the panel in its evaluation of the challenge.<sup>13</sup>

**3.2.2** WADA-accredited laboratories, and other laboratories approved by WADA, are presumed to have conducted *Sample* analysis and custodial procedures in accordance with the *International Standard for Laboratories*. The *Athlete* or other *Person* may rebut this presumption by establishing that a departure from the *International Standard for Laboratories* occurred which could reasonably have caused the *Adverse Analytical Finding*.

If the *Athlete* or other *Person* rebuts the preceding presumption by showing that a departure from the *International Standard for Laboratories* occurred which could reasonably have caused the *Adverse Analytical Finding*, then the UIM shall have the burden to establish that such departure did not cause the *Adverse Analytical Finding*.<sup>14</sup>

**3.2.3** Departures from any other *International Standard* or other anti-doping rule or policy set forth in the *Code* or these Anti-Doping Rules shall not invalidate

<sup>11</sup> *Comment to Article 3.1: This standard of proof required to be met by the UIM is comparable to the standard which is applied in most countries to cases involving professional misconduct.]*

<sup>12</sup> *[Comment to Article 3.2: For example, the UIM may establish an anti-doping rule violation under Article 2.2 based on the Athlete's admissions, the credible testimony of third Persons, reliable documentary evidence, reliable analytical data from either an A or B Sample as provided in the Comments to Article 2.2, or conclusions drawn from the profile of a series of the Athlete's blood or urine Samples, such as data from the Athlete Biological Passport.]*

<sup>13</sup> *[Comment to Article 3.2.1: For certain Prohibited Substances, WADA may instruct WADA-accredited laboratories not to report Samples as an Adverse Analytical Finding if the estimated concentration of the Prohibited Substance or its Metabolites or Markers is below a Minimum Reporting Level. WADA's decision in determining that Minimum Reporting Level or in determining which Prohibited Substances should be subject to Minimum Reporting Levels shall not be subject to challenge. Further, the laboratory's estimated concentration of such Prohibited Substance in a Sample may only be an estimate. In no event shall the possibility that the exact concentration of the Prohibited Substance in the Sample may be below the Minimum Reporting Level constitute a defense to an anti-doping rule violation based on the presence of that Prohibited Substance in the Sample.]*

<sup>14</sup> *[Comment to Article 3.2.2: The burden is on the Athlete or other Person to establish, by a balance of probability, a departure from the International Standard for Laboratories that could reasonably have caused the Adverse Analytical Finding. Thus, once the Athlete or other Person establishes the departure by a balance of probability, the Athlete or other Person's burden on causation is the somewhat lower standard of proof – "could reasonably have caused." If the Athlete or other Person satisfies these standards, the burden shifts to the UIM to prove to the comfortable satisfaction of the hearing panel that the departure did not cause the Adverse Analytical Finding.]*

analytical results or other evidence of an anti-doping rule violation, and shall not constitute a defense to an anti-doping rule violation;<sup>15</sup> provided, however, if the *Athlete* or other *Person* establishes that a departure from one of the specific *International Standard* provisions listed below could reasonably have caused an anti-doping rule violation based on an *Adverse Analytical Finding* or whereabouts failure, then the UIM shall have the burden to establish that such departure did not cause the *Adverse Analytical Finding* or the whereabouts failure:

- (i) a departure from the *International Standard for Testing and Investigations* related to *Sample* collection or *Sample* handling which could reasonably have caused an anti-doping rule violation based on an *Adverse Analytical Finding*, in which case the UIM shall have the burden to establish that such departure did not cause the *Adverse Analytical Finding*;
- (ii) a departure from the *International Standard for Results Management* or *International Standard for Testing and Investigations* related to an *Adverse Passport Finding* which could reasonably have caused an anti-doping rule violation, in which case the UIM shall have the burden to establish that such departure did not cause the anti-doping rule violation;
- (iii) a departure from the *International Standard for Results Management* related to the requirement to provide notice to the *Athlete* of the B *Sample* opening which could reasonably have caused an anti-doping rule violation based on an *Adverse Analytical Finding*, in which case the UIM shall have the burden to establish that such departure did not cause the *Adverse Analytical Finding*;<sup>16</sup>
- (iv) a departure from the *International Standard for Results Management* related to *Athlete* notification which could reasonably have caused an anti-doping rule violation based on a whereabouts failure, in which case the UIM shall have the burden to establish that such departure did not cause the whereabouts failure.

**3.2.4** The facts established by a decision of a court or professional disciplinary tribunal of competent jurisdiction which is not the subject of a pending appeal shall be irrebuttable evidence against the *Athlete* or other *Person* to whom the decision pertained of those facts unless the *Athlete* or other *Person* establishes that the decision violated principles of natural justice.

**3.2.5** The hearing panel in a hearing on an anti-doping rule violation may draw an inference adverse to the *Athlete* or other *Person* who is asserted to have committed an anti-doping rule violation based on the *Athlete's* or other *Person's* refusal, after a request made in a reasonable time in advance of the hearing, to appear at the hearing (either in person or telephonically as

<sup>15</sup> [Comment to Article 3.2.3: Departures from an *International Standard* or other rule unrelated to *Sample* collection or handling, *Adverse Passport Finding*, or *Athlete* notification relating to whereabouts failure or B *Sample* opening – e.g., the *International Standards for Education*, *International Standard for the Protection of Privacy and Personal Information* or *International Standard for Therapeutic Use Exemptions* – may result in compliance proceedings by WADA but are not a defense in an anti-doping rule violation proceeding and are not relevant on the issue of whether the *Athlete* committed an anti-doping rule violation. Similarly, the UIM's violation of the document referenced in Article 20.7.7 of the Code shall not constitute a defense to an anti-doping rule violation.]

<sup>16</sup> [Comment to Article 3.2.3 (iii): the UIM would meet its burden to establish that such departure did not cause the *Adverse Analytical Finding* by showing that, for example, the B *Sample* opening and analysis were observed by an independent witness and no irregularities were observed.]

directed by the hearing panel) and to answer questions from the hearing panel or the UIM.

## ARTICLE 4 THE PROHIBITED LIST

### **4.1 Incorporation of the Prohibited List**

These Anti-Doping Rules incorporate the *Prohibited List*, which is published and revised by WADA as described in Article 4.1 of the *Code*.

Unless provided otherwise in the *Prohibited List* or a revision, the *Prohibited List* and revisions shall go into effect under these Anti-Doping Rules three (3) months after publication by WADA, without requiring any further action by the UIM or its *National Authorities*. All *Athletes* and other *Persons* shall be bound by the *Prohibited List*, and any revisions thereto, from the date they go into effect, without further formality. It is the responsibility of all *Athletes* and other *Persons* to familiarize themselves with the most up-to-date version of the *Prohibited List* and all revisions thereto.

The UIM shall provide its *National Authorities* with the most recent version of the *Prohibited List*. Each *National Authority* shall in turn ensure that its members, and the constituents of its members, are also provided with the most recent version of the *Prohibited List*.<sup>17</sup>

### **4.2 Prohibited Substances and Prohibited Methods Identified on the Prohibited List**

#### **4.2.1 Prohibited Substances and Prohibited Methods**

The *Prohibited List* shall identify those *Prohibited Substances* and *Prohibited Methods* which are prohibited as doping at all times (both *In-Competition* and *Out-of-Competition*) because of their potential to enhance performance in future *Competitions* or their masking potential, and those substances and methods which are prohibited *In-Competition* only. The *Prohibited List* may be expanded by WADA for a particular sport. *Prohibited Substances* and *Prohibited Methods* may be included in the *Prohibited List* by general category (e.g., anabolic agents) or by specific reference to a particular substance or method.<sup>18</sup>

#### **4.2.2 Specified Substances or Specified Methods**

For purposes of the application of Article 10, all *Prohibited Substances* shall be *Specified Substances* except as identified on the *Prohibited List*. No *Prohibited Method* shall be a *Specified Method* unless it is specifically identified as a *Specified Method* on the *Prohibited List*.<sup>19</sup>

#### **4.2.3 Substances of Abuse**

For purposes of applying Article 10, *Substances of Abuse* shall include those *Prohibited Substances* which are specifically identified as *Substances of Abuse* on the *Prohibited List* because they are frequently abused in society outside of the context of sport.

<sup>17</sup> [Comment to Article 4.1: The current *Prohibited List* is available on WADA's website at <https://www.wada-ama.org>. The *Prohibited List* will be revised and published on an expedited basis whenever the need arises. However, for the sake of predictability, a new *Prohibited List* will be published every year whether or not changes have been made.]

<sup>18</sup> [Comment to Article 4.2.1: *Out-of-Competition* Use of a substance which is only prohibited *In-Competition* is not an anti-doping rule violation unless an Adverse Analytical Finding for the substance or its Metabolites or Markers is reported for a Sample collected *In-Competition*.]

<sup>19</sup> [Comment to Article 4.2.2: The *Specified Substances* and *Methods* identified in Article 4.2.2 should not in any way be considered less important or less dangerous than other doping substances or methods. Rather, they are simply substances and methods which are more likely to have been consumed or used by an Athlete for a purpose other than the enhancement of sport performance.]

### **4.3 WADA's Determination of the Prohibited List**

WADA's determination of the *Prohibited Substances* and *Prohibited Methods* that will be included on the *Prohibited List*, the classification of substances into categories on the *Prohibited List*, the classification of a substance as prohibited at all times or *In-Competition* only, the classification of a substance or method as a *Specified Substance*, *Specified Method* or *Substance of Abuse* is final and shall not be subject to any challenge by an *Athlete* or other *Person* including, but not limited to, any challenge based on an argument that the substance or method was not a masking agent or did not have the potential to enhance performance, represent a health risk or violate the spirit of sport.

### **4.4 Therapeutic Use Exemptions ("TUEs")**

- 4.4.1** The presence of a *Prohibited Substance* or its *Metabolites* or *Markers*, and/or the *Use* or *Attempted Use*, *Possession* or *Administration* or *Attempted Administration* of a *Prohibited Substance* or *Prohibited Method*, shall not be considered an anti-doping rule violation if it is consistent with the provisions of a *TUE* granted in accordance with the *International Standard for Therapeutic Use Exemptions*.
- 4.4.2** *TUE* Applications
- 4.4.2.1** *Athletes* who are not *International-Level Athletes* shall apply to their *National Anti-Doping Organization* for a *TUE*. If the *National Anti-Doping Organization* denies the application, the *Athlete* may appeal exclusively to the national-level appeal body described in Article 13.2.2.
- 4.4.2.2** *Athletes* who are *International-Level Athletes* shall apply to the UIM.
- 4.4.3** *TUE* Recognition<sup>20</sup>
- 4.4.3.1** Where the *Athlete* already has a *TUE* granted by their *National Anti-Doping Organization* pursuant to Article 4.4 of the *Code* for the substance or method in question and provided that such *TUE* has been reported in accordance with Article 5.5 of the *International Standard for Therapeutic Use Exemptions*, the UIM will automatically recognize it for purposes of international-level *Competition* without the need to review the relevant clinical information.
- 4.4.3.2** If the UIM chooses to test an *Athlete* who is not an *International-Level Athlete*, the UIM must recognize a *TUE* granted to that *Athlete* by their *National Anti-Doping Organization* unless the *Athlete* is required to apply for recognition of the *TUE* pursuant to Articles 5.8 and 7.0 of the *International Standard for Therapeutic Use Exemptions*.
- 4.4.4** *TUE* Application Process<sup>21</sup>

<sup>20</sup> [Comment to Article 4.4.3: If the UIM refuses to recognize a *TUE* granted by a *National Anti-Doping Organization* only because medical records or other information are missing that are needed to demonstrate satisfaction with the criteria in the *International Standard for Therapeutic Use Exemptions*, the matter should not be referred to WADA. Instead, the file should be completed and re-submitted to the UIM.]

[Comment to Article 4.4.3: the UIM may agree with a *National Anti-Doping Organization* that the *National Anti-Doping Organization* will consider *TUE* applications on behalf of the UIM.]

<sup>21</sup> [Comment to Article 4.4.4: The submission of falsified documents to a *TUEC* or the UIM, offering or accepting a bribe to a *Person* to perform or fail to perform an act, procuring false testimony from any witness, or committing any other fraudulent act or any other similar intentional interference or *Attempted interference* with any aspect of the *TUE* process shall result in a charge of *Tampering* or *Attempted Tampering* under Article 2.5.]

- 4.4.4.1** If the *Athlete* does not already have a *TUE* granted by their *National Anti-Doping Organization* for the substance or method in question, the *Athlete* must apply directly to the UIM.
- 4.4.4.2** An application to the UIM for grant or recognition of a *TUE* must be made as soon as possible, save where Articles 4.1 or 4.3 of the *International Standard for Therapeutic Use Exemptions* apply. The application shall be made in accordance with Article 6 of the *International Standard for Therapeutic Use Exemptions* as posted on the UIM's website.
- 4.4.4.3** The UIM shall establish a *Therapeutic Use Exemption Committee* ("TUEC") to consider applications for the grant or recognition of *TUEs*. in accordance with Article 4.4.4.3(a)-(d) below:
- (a) The TUEC shall consist of a minimum of five (5) members with experience in the care and treatment of *Athletes* and sound knowledge of clinical, sports and exercise medicine. Each appointed member should serve a term of four (4) years which is renewable.
  - (b) Before serving as a member of the TUEC, each member must sign a conflict of interest and confidentiality declaration. The appointed members shall not be employees of [IF]the UIM.
  - (c) When an application to [IF]the UIM for the grant or recognition of a *TUE* is made, the Chair of the TUEC or the [IF]the UIM shall appoint three (3) members (which may include the Chair) to consider the application.
  - (d) Before considering a *TUE* application, each member shall disclose any circumstances likely to affect their impartiality with respect to the *Athlete* making the application. If a member is unwilling or unable to assess the *Athlete's TUE* application, for any reason, the Chair or the [IF]the UIM shall appoint a replacement from the pool of members appointed under point (a) above. The Chair cannot serve as a member of the TUEC if there are any circumstances which are likely to affect the impartiality of the *TUE* decision.
- 4.4.4.4** The TUEC shall promptly evaluate and decide upon the application in accordance with the relevant provisions of the *International Standard for Therapeutic Use Exemptions* and usually (i.e., unless exceptional circumstances apply) within no more than twenty-one (21) days of receipt of a complete application. Where the application is made in a reasonable time prior to an *Event*, the TUEC must use its best endeavors to issue its decision before the start of the *Event*.
- 4.4.4.5** The TUEC decision shall be the final decision of the UIM and may be appealed in accordance with Article 4.4.7. the UIM TUEC decision shall be notified in writing to the *Athlete*, and to WADA and other *Anti-Doping Organizations* in accordance with the *International Standard for Therapeutic Use Exemptions*. It shall also promptly be reported into ADAMS.
- 4.4.4.6** If the UIM (or the *National Anti-Doping Organization*, where it has agreed to consider the application on behalf of the UIM) denies the

---

*An Athlete should not assume that their application for the grant or recognition of a TUE (or for renewal of a TUE) will be granted. Any Use or Possession or Administration of a Prohibited Substance or Prohibited Method before an application has been granted is entirely at the Athlete's own risk.*

*Athlete's* application, it must notify the *Athlete* promptly, with reasons. If the UIM grants the *Athlete's* application, it must notify not only the *Athlete* but also their *National Anti-Doping Organization*. If the *National Anti-Doping Organization* considers that the *TUE* granted by the UIM does not meet the criteria set out in the *International Standard for Therapeutic Use Exemptions*, it has twenty-one (21) days from such notification to refer the matter to *WADA* for review in accordance with Article 4.4.7.

If the *National Anti-Doping Organization* refers the matter to *WADA* for review, the *TUE* granted by the UIM remains valid for international-level *Competition* and *Out-of-Competition Testing* (but is not valid for national-level *Competition*) pending *WADA's* decision. If the *National Anti-Doping Organization* does not refer the matter to *WADA* for review, the *TUE* granted by the UIM becomes valid for national-level *Competition* as well when the twenty-one (21) day review deadline expires.

#### 4.4.5 Retroactive TUE Applications

If the UIM chooses to collect a *Sample* from an *Athlete* who is not an *International-Level Athlete* or a *National-Level Athlete*, and that *Athlete* is *Using a Prohibited Substance or Prohibited Method* for therapeutic reasons, the UIM must permit that *Athlete* to apply for a retroactive *TUE*.

#### 4.4.6 Expiration, Withdrawal or Reversal of a TUE

**4.4.6.1** A *TUE* granted pursuant to these Anti-Doping Rules: (a) shall expire automatically at the end of any term for which it was granted, without the need for any further notice or other formality; (b) will be withdrawn if the *Athlete* does not promptly comply with any requirements or conditions imposed by the TUEC upon grant of the *TUE*; (c) may be withdrawn by the TUEC if it is subsequently determined that the criteria for grant of a *TUE* are not in fact met; or (d) may be reversed on review by *WADA* or on appeal.

**4.4.6.2** In such event, the *Athlete* shall not be subject to any *Consequences* based on their *Use or Possession or Administration of the Prohibited Substance or Prohibited Method* in question in accordance with the *TUE* prior to the effective date of expiry, withdrawal, or reversal of the *TUE*. The review pursuant to Article 5.1.1.1 of the *International Standard for Results Management of an Adverse Analytical Finding*, reported shortly after the *TUE* expiry, withdrawal or reversal, shall include consideration of whether such finding is consistent with *Use of the Prohibited Substance or Prohibited Method* prior to that date, in which event no anti-doping rule violation shall be asserted.

#### 4.4.7 Reviews and Appeals of TUE Decisions

**4.4.7.1** *WADA* must review the UIM's decision not to recognize a *TUE* granted by the *National Anti-Doping Organization* that is referred to *WADA* by the *Athlete* or the *Athlete's National Anti-Doping Organization*. In addition, *WADA* must review the UIM's decision to grant a *TUE* that is referred to *WADA* by the *Athlete's National Anti-Doping Organization*. *WADA* may review any other *TUE* decisions at any time, whether upon request by those affected or on its own initiative. If the *TUE* decision being reviewed meets the criteria set out in the *International Standard for Therapeutic Use*

*Exemptions*, WADA will not interfere with it. If the *TUE* decision does not meet those criteria, WADA will reverse it.<sup>22</sup>

- 4.4.7.2** Any *TUE* decision by the UIM (or by a *National Anti-Doping Organization* where it has agreed to consider the application on behalf of the UIM) that is not reviewed by WADA, or that is reviewed by WADA but is not reversed upon review, may be appealed by the *Athlete* and/or the *Athlete's National Anti-Doping Organization*, exclusively to CAS.<sup>23</sup>
- 4.4.7.3** A decision by WADA to reverse a *TUE* decision may be appealed by the *Athlete*, the *National Anti-Doping Organization* and/or the UIM, exclusively to CAS.
- 4.4.7.4** A failure to render a decision within a reasonable time on a properly submitted application for grant/recognition of a *TUE* or for review of a *TUE* decision shall be considered a denial of the application thus triggering the applicable rights of review/appeal.

## ARTICLE 5 TESTING AND INVESTIGATIONS

### **5.1 Purpose of Testing and Investigations**<sup>24</sup>

- 5.1.1** *Testing* and investigations may be undertaken for any anti-doping purpose. They shall be conducted in conformity with the provisions of the *International Standard for Testing and Investigations*.
- 5.1.2** *Testing* shall be undertaken to obtain analytical evidence as to whether the *Athlete* has violated Article 2.1 (Presence of a *Prohibited Substance* or its *Metabolites* or *Markers* in an *Athlete's Sample*) or Article 2.2 (*Use or Attempted Use* by an *Athlete* of a *Prohibited Substance* or a *Prohibited Method*).

### **5.2 Authority to Test**

- 5.2.1** Subject to the limitations for *Event Testing* set out in Article 5.3, the UIM shall have *In-Competition* and *Out-of-Competition Testing* authority over all *Athletes* specified in the Introduction to these Anti-Doping Rules (Section "Scope of these Anti-Doping Rules").
- 5.2.2** The UIM may require any *Athlete* over whom it has *Testing* authority (including any *Athlete* serving a period of *Ineligibility*) to provide a *Sample* at any time and at any place.<sup>25</sup>

<sup>22</sup> [Comment to Article 4.4.7.1: WADA shall be entitled to charge a fee to cover the costs of: (a) any review it is required to conduct in accordance with Article 4.4.7; and (b) any review it chooses to conduct, where the decision being reviewed is reversed.]

<sup>23</sup> [Comment to Article 4.4.7.2: In such cases, the decision being appealed is the the UIM's *TUE* decision, not WADA's decision not to review the *TUE* decision or (having reviewed it) not to reverse the *TUE* decision. However, the time to appeal the *TUE* decision does not begin to run until the date that WADA communicates its decision. In any event, whether the decision has been reviewed by WADA or not, WADA shall be given notice of the appeal so that it may participate if it sees fit.]

<sup>24</sup> [Comment to Article 5.1: Where *Testing* is conducted for anti-doping purposes, the analytical results and data may be used for other legitimate purposes under the Anti-Doping Organization's rules. See, e.g., Comment to Article 23.2.2 of the Code.]

<sup>25</sup> [Comment to Article 5.2.2: the UIM may obtain additional authority to conduct *Testing* by means of bilateral or multilateral agreements with other Signatories. Unless the *Athlete* has identified a sixty (60) minute *Testing* window between the hours of 11:00 p.m. and 6:00 a.m., or has otherwise consented to *Testing* during that period, the UIM will not test an *Athlete* during that period unless it has a serious and specific suspicion that the *Athlete* may be engaged in doping. A challenge to whether the UIM had sufficient suspicion for *Testing* during this time period shall not be a defense to an anti-doping rule violation based on such test or attempted test.]



- 5.2.3** WADA shall have *In-Competition* and *Out-of-Competition Testing* authority as set out in Article 20.7.10 of the *Code*.
- 5.2.4** If the UIM delegates or contracts any part of *Testing* to a *National Anti-Doping Organization* directly or through a *National Authority*, that *National Anti-Doping Organization* may collect additional *Samples* or direct the laboratory to perform additional types of analysis at the *National Anti-Doping Organization's* expense. If additional *Samples* are collected or additional types of analysis are performed, the UIM shall be notified.

### **5.3 Event Testing**

- 5.3.1** Except as otherwise provided below, only a single organization shall have authority to conduct *Testing* at *Event Venues* during an *Event Period*. At *International Events*, the UIM (or other international organization which is the ruling body for an *Event*) shall have authority to conduct *Testing*. At *National Events*, the *National Anti-Doping Organization* of that country shall have authority to conduct *Testing*. At the request of the UIM (or other international organization which is the ruling body for an *Event*), any *Testing* during the *Event Period* outside of the *Event Venues* shall be coordinated with the UIM (or the relevant ruling body of the *Event*).
- 5.3.2** If an *Anti-Doping Organization*, which would otherwise have *Testing* authority but is not responsible for initiating and directing *Testing* at an *Event*, desires to conduct *Testing of Athletes* at the *Event Venues* during the *Event Period*, the *Anti-Doping Organization* shall first confer with the UIM (or other international organization which is the ruling body of the *Event*) to obtain permission to conduct and coordinate such *Testing*. If the *Anti-Doping Organization* is not satisfied with the response from the UIM (or other international organization which is the ruling body of the *Event*), the *Anti-Doping Organization* may, in accordance with the procedures described in the *International Standard for Testing and Investigations*, ask WADA for permission to conduct *Testing* and to determine how to coordinate such *Testing*. WADA shall not grant approval for such *Testing* before consulting with and informing the UIM (or other international organization which is the ruling body for the *Event*). WADA's decision shall be final and not subject to appeal. Unless otherwise provided in the authorization to conduct *Testing*, such tests shall be considered *Out-of-Competition* tests. *Results Management* for any such test shall be the responsibility of the *Anti-Doping Organization* initiating the test unless provided otherwise in the rules of the ruling body of the *Event*.<sup>26</sup>

### **5.4 Testing Requirements**

- 5.4.1** The UIM shall conduct test distribution planning and *Testing* as required by the *International Standard for Testing and Investigations*.
- 5.4.2** Where reasonably feasible, *Testing* shall be coordinated through ADAMS in order to maximize the effectiveness of the combined *Testing* effort and to avoid unnecessary repetitive *Testing*.

### **5.5 Athlete Whereabouts Information**

<sup>26</sup> [Comment to Article 5.3.2: Before giving approval to a National Anti-Doping Organization to initiate and conduct Testing at an International Event, WADA shall consult with the international organization which is the ruling body for the Event. Before giving approval to an International Federation to initiate and conduct Testing at a National Event, WADA shall consult with the National Anti-Doping Organization of the country where the Event takes place. The Anti-Doping Organization "initiating and directing Testing" may, if it chooses, enter into agreements with a Delegated Third Party to which it delegates responsibility for Sample collection or other aspects of the Doping Control process.]

- 5.5.1** The UIM may establish a *Registered Testing Pool* of those *Athletes* who are required to provide whereabouts information in the manner specified in the *International Standard for Testing and Investigations* and who shall be subject to *Consequences* for Article 2.4 violations as provided in Article 10.3.2. the UIM shall coordinate with *National Anti-Doping Organizations* to identify such *Athletes* and to collect their whereabouts information.
- 5.5.2** The UIM shall make available through ADAMS a list which identifies those *Athletes* included in its *Registered Testing Pool* by name. the UIM shall regularly review and update as necessary its criteria for including *Athletes* in its *Registered Testing Pool*, and shall periodically (but not less than quarterly) review the list of *Athletes* in its *Registered Testing Pool* to ensure that each listed *Athlete* continues to meet the relevant criteria. *Athletes* shall be notified before they are included in the *Registered Testing Pool* and when they are removed from that pool. The notification shall contain the information set out in the *International Standard for Testing and Investigations*.
- 5.5.3** Where an *Athlete* is included in an international *Registered Testing Pool* by the UIM and in a national *Registered Testing Pool* by their *National Anti-Doping Organization*, the *National Anti-Doping Organization* and the UIM shall agree between themselves which of them shall accept that *Athlete's* whereabouts filings; in no case shall an *Athlete* be required to make whereabouts filings to more than one of them.
- 5.5.4** In accordance with the *International Standard for Testing and Investigations*, each *Athlete* in the *Registered Testing Pool* shall do the following: (a) advise the UIM of his/her whereabouts on a quarterly basis; (b) update that information as necessary so that it remains accurate and complete at all times; and (c) make himself or herself available for *Testing* at such whereabouts.
- 5.5.5** For purposes of Article 2.4, an *Athlete's* failure to comply with the requirements of the *International Standard for Testing and Investigations* shall be deemed a filing failure or a missed test, as defined in Annex B of the *International Standard for Results Management*, where the conditions set forth in Annex B are met.
- 5.5.6** An *Athlete* in the UIM's *Registered Testing Pool* shall continue to be subject to the obligation to comply with the whereabouts requirements set in the *International Standard for Testing and Investigations* unless and until (a) the *Athlete* gives written notice to the UIM that he or she has retired or (b) the UIM has informed him or her that he or she no longer satisfies the criteria for inclusion in the UIM's *Registered Testing Pool*.
- 5.5.7** Whereabouts information provided by an *Athlete* while in the *Registered Testing Pool* will be accessible through ADAMS to WADA and to other *Anti-Doping Organizations* having authority to test that *Athlete* as provided in Article 5.2. Whereabouts information shall be maintained in strict confidence at all times; it shall be used exclusively for purposes of planning, coordinating or conducting *Doping Control*, providing information relevant to the *Athlete Biological Passport* or other analytical results, to support an investigation into a potential anti-doping rule violation, or to support proceedings alleging an anti-doping rule violation; and shall be destroyed after it is no longer relevant for these purposes in accordance with the *International Standard for the Protection of Privacy and Personal Information*.
- 5.5.8** The UIM may, in accordance with the *International Standard for Testing and Investigations*, collect whereabouts information from *Athletes* who are not included within a *Registered Testing Pool*. If it chooses to do so, an *Athlete's* failure to provide requested whereabouts information on or before the date

required by the UIM or the *Athlete's* failure to provide accurate whereabouts information may result in consequences defined in Article 5.5.12 below (if one established).

- 5.5.9** In accordance with the International Standard for Testing and Investigations, the UIM may establish a *Testing Pool*, which includes *Athletes* who are subject to less stringent whereabouts requirements than *Athletes* included in the UIM's *Registered Testing Pool*.
- 5.5.10** The UIM shall notify *Athletes* before they are included in the *Testing Pool* and when they are removed. Such notification shall include the whereabouts requirements and the consequences that apply in case of non-compliance, as indicated in Articles 5.5.11 and 5.5.12.
- 5.5.11** *Athletes* included in the *Testing Pool* shall provide the UIM at least with the following whereabouts information so that they may be located and subjected to *Testing*:
- (a) An overnight address;
  - (b) Competition / Event schedule; and
  - (c) Regular training activities.
- Such whereabouts information shall be filed in ADAMS to enable better *Testing* coordination with other *Anti-Doping Organizations*.
- 5.5.12** An *Athlete's* failure to provide whereabouts information on or before the date required by the UIM or the *Athlete's* failure to provide accurate whereabouts information may result in the UIM elevating the *Athlete* to the UIM's *Registered Testing Pool* (if one established) and additional appropriate and proportionate non-Code Article 2.4 consequences, established by the UIM if any.

## **5.6 Retired Athletes Returning to Competition**

- 5.6.1** If an *International-Level Athlete* or *National-Level Athlete* in the UIM's *Registered Testing Pool* retires and then wishes to return to active participation in sport, the *Athlete* shall not compete in *International Events* or *National Events* until the *Athlete* has made himself or herself available for *Testing*, by giving six (6) months prior written notice to the UIM and their *National Anti-Doping Organization*.

WADA, in consultation with the UIM and the *Athlete's National Anti-Doping Organization*, may grant an exemption to the six (6) month written notice rule where the strict application of that rule would be unfair to the *Athlete*. This decision may be appealed under Article 13.<sup>27</sup>

Any competitive results obtained in violation of this Article 5.6.1 shall be *Disqualified* unless the *Athlete* can establish that he or she could not have reasonably known that this was an *International Event* or a *National Event*.

- 5.6.2** If an *Athlete* retires from sport while subject to a period of *Ineligibility*, the *Athlete* must notify the *Anti-Doping Organization* that imposed the period of *Ineligibility* in writing of such retirement. If the *Athlete* then wishes to return to active competition in sport, the *Athlete* shall not compete in *International Events* or *National Events* until the *Athlete* has made himself or herself available for *Testing* by giving six (6) months prior written notice (or notice equivalent to the period of *Ineligibility* remaining as of the date the *Athlete* retired, if that period was longer than six (6) months) to the UIM and to their *National Anti-Doping Organization*.

<sup>27</sup> [Comment to Article 5.6.1: WADA has developed a protocol and exemption application form that *Athletes* must use to make such requests, and a decision template that the *International Federations* must use. Both documents are available on WADA's website at <https://www.wada-ama.org>.]

## **5.7 Independent Observer Program**

The UIM and the organizing committees for the UIM's *Events*, as well as the *National Authorities* and the organizing committees for *National Events*, shall authorize and facilitate the *Independent Observer Program* at such *Events*.

## **ARTICLE 6 ANALYSIS OF SAMPLES**

*Samples* shall be analyzed in accordance with the following principles:

### **6.1 Use of Accredited, Approved Laboratories and Other Laboratories**

- 6.1.1** For purposes of directly establishing an *Adverse Analytical Finding* under Article 2.1, *Samples* shall be analyzed only in WADA-accredited laboratories or laboratories otherwise approved by WADA. The choice of the WADA-accredited or WADA-approved laboratory used for the *Sample* analysis shall be determined exclusively by the UIM.<sup>28</sup>
- 6.1.2** As provided in Article 3.2, facts related to anti-doping rule violations may be established by any reliable means. This would include, for example, reliable laboratory or other forensic testing conducted outside of WADA-accredited or approved laboratories.

### **6.2 Purpose of Analysis of Samples and Data**

*Samples* and related analytical data or *Doping Control* information shall be analyzed to detect *Prohibited Substances* and *Prohibited Methods* identified on the *Prohibited List* and other substances as may be directed by WADA pursuant to the monitoring program described in Article 4.5 of the *Code*, or to assist the UIM in profiling relevant parameters in an *Athlete's* urine, blood or other matrix, including for DNA or genomic profiling, or for any other legitimate anti-doping purpose.<sup>29</sup>

### **6.3 Research on Samples and Data**

*Samples*, related analytical data and *Doping Control* information may be used for anti-doping research purposes, although no *Sample* may be used for research without the *Athlete's* written consent. *Samples* and related analytical data or *Doping Control* information used for research purposes shall first be processed in such a manner as to prevent *Samples* and related analytical data or *Doping Control* information being traced back to a particular *Athlete*. Any research involving *Samples* and related analytical data or *Doping Control* information shall adhere to the principles set out in Article 19 of the *Code*.<sup>30</sup>

### **6.4 Standards for Sample Analysis and Reporting**

<sup>28</sup> [Comment to Article 6.1: Violations of Article 2.1 may be established only by *Sample* analysis performed by a WADA-accredited laboratory or another laboratory approved by WADA. Violations of other Articles may be established using analytical results from other laboratories so long as the results are reliable.]

<sup>29</sup> [Comment to Article 6.2: For example, relevant *Doping Control*-related information could be used to direct *Target Testing* or to support an anti-doping rule violation proceeding under Article 2.2, or both.]

<sup>30</sup> [Comment to Article 6.3: As is the case in most medical or scientific contexts, use of *Samples* and related information for quality assurance, quality improvement, method improvement and development or to establish reference populations is not considered research. *Samples* and related information used for such permitted non-research purposes must also first be processed in such a manner as to prevent them from being traced back to the particular *Athlete*, having due regard to the principles set out in Article 19 of the *Code*, as well as the requirements of the *International Standard for Laboratories and International Standard for the Protection of Privacy and Personal Information*.]

In accordance with Article 6.4 of the Code, the UIM shall ask laboratories to analyze *Samples* in conformity with the *International Standard for Laboratories* and Article 4.7 of the *International Standard for Testing and Investigations*.

Laboratories at their own initiative and expense may analyze *Samples* for *Prohibited Substances* or *Prohibited Methods* not included on the standard *Sample* analysis menu, or as requested by the UIM. Results from any such analysis shall be reported to the UIM and have the same validity and *Consequences* as any other analytical result.<sup>31</sup>

#### **6.5 Further Analysis of a Sample Prior to or During Results Management**

There shall be no limitation on the authority of a laboratory to conduct repeat or additional analysis on a *Sample* prior to the time the UIM notifies an *Athlete* that the *Sample* is the basis for an Article 2.1 anti-doping rule violation charge. If after such notification the UIM wishes to conduct additional analysis on that *Sample*, it may do so with the consent of the *Athlete* or approval from a hearing body.

#### **6.6 Further Analysis of a Sample After it has been Reported as Negative or has Otherwise not Resulted in an Anti-Doping Rule Violation Charge**

After a laboratory has reported a *Sample* as negative, or the *Sample* has not otherwise resulted in an anti-doping rule violation charge, it may be stored and subjected to further analyses for the purpose of Article 6.2 at any time exclusively at the direction of either the *Anti-Doping Organization* that initiated and directed *Sample* collection or WADA. Any other *Anti-Doping Organization* with authority to test the *Athlete* that wishes to conduct further analysis on a stored *Sample* may do so with the permission of the *Anti-Doping Organization* that initiated and directed *Sample* collection or WADA, and shall be responsible for any follow-up *Results Management*. Any *Sample* storage or further analysis initiated by WADA or another *Anti-Doping Organization* shall be at WADA's or that organization's expense. Further analysis of *Samples* shall conform with the requirements of the *International Standard for Laboratories*.

#### **6.7 Split of A or B Sample**

Where WADA, an *Anti-Doping Organization* with *Results Management* authority, and/or a WADA-accredited laboratory (with approval from WADA or the *Anti-Doping Organization* with *Results Management* authority) wishes to split an A or B *Sample* for the purpose of using the first part of the split *Sample* for an A *Sample* analysis and the second part of the split *Sample* for confirmation, then the procedures set forth in the *International Standard for Laboratories* shall be followed.

#### **6.8 WADA's Right to Take Possession of Samples and Data**

WADA may, in its sole discretion at any time, with or without prior notice, take physical possession of any *Sample* and related analytical data or information in the possession of a laboratory or *Anti-Doping Organization*. Upon request by WADA, the laboratory or *Anti-Doping Organization* in possession of the *Sample* or data shall immediately grant access to and enable WADA to take physical possession of the *Sample* or data. If WADA has not provided prior notice to the laboratory or *Anti-Doping Organization* before taking possession of a *Sample* or data, it shall provide such notice to the laboratory and each *Anti-Doping Organization* whose *Samples* or data have been taken by WADA within a reasonable time after taking possession. After analysis and any investigation of a seized *Sample* or data, WADA may direct another *Anti-Doping Organization* with authority to test the *Athlete* to assume *Results Management* responsibility for the *Sample* or data if a potential anti-doping rule violation is discovered.<sup>32</sup>

<sup>31</sup> [Comment to Article 6.4: The objective of this Article is to extend the principle of "Intelligent Testing" to the *Sample* analysis menu so as to most effectively and efficiently detect doping. It is recognized that the resources available to fight doping are limited and that increasing the *Sample* analysis menu may, in some sports and countries, reduce the number of *Samples* which can be analyzed.]

<sup>32</sup> [Comment to Article 6.8: Resistance or refusal to WADA taking physical possession of *Samples* or data could constitute Tampering, Complicity or an act of non-compliance as provided in the *International Standard for Code Compliance by Signatories*, and could also constitute a violation of the *International Standard for Laboratories*. Where necessary, the laboratory and/or the *Anti-Doping Organization* shall assist WADA in ensuring that the seized *Sample* or data are not delayed in exiting the applicable country.]

## ARTICLE 7 RESULTS MANAGEMENT: RESPONSIBILITY, INITIAL REVIEW, NOTICE AND PROVISIONAL SUSPENSIONS

*Results Management* under these Anti-Doping Rules establishes a process designed to resolve anti-doping rule violation matters in a fair, expeditious and efficient manner.

### 7.1 Responsibility for Conducting Results Management

- 7.1.1** Except as otherwise provided in Articles 6.6, 6.8 and Code Article 7.1, *Results Management* shall be the responsibility of, and shall be governed by, the procedural rules of the *Anti-Doping Organization* that initiated and directed *Sample* collection (or, if no *Sample* collection is involved, the *Anti-Doping Organization* which first provides notice to an *Athlete* or other *Person* of a potential anti-doping rule violation and then diligently pursues that anti-doping rule violation).
- 7.1.2** In circumstances where the rules of a *National Anti-Doping Organization* do not give the *National Anti-Doping Organization* authority over an *Athlete* or other *Person* who is not a national, resident, license holder, or member of a sport organization of that country, or the *National Anti-Doping Organization* declines to exercise such authority, *Results Management* shall be conducted by the applicable International Federation or by a third party with authority over the *Athlete* or other *Person* as directed by the rules of the applicable International Federation.
- 7.1.3** In the event the *Major Event Organization* assumes only limited *Results Management* responsibility relating to a *Sample* initiated and taken during an *Event* conducted by a *Major Event Organization*, or an anti-doping rule violation occurring during such *Event*, the case shall be referred by the *Major Event Organization* to the applicable International Federation for completion of *Results Management*.
- 7.1.4** *Results Management* in relation to a potential whereabouts failure (a filing failure or a missed test) shall be administered by the UIM or the *National Anti-Doping Organization* with whom the *Athlete* in question files whereabouts information, as provided in the *International Standard for Results Management*. If the UIM determines a filing failure or a missed test, it shall submit that information to WADA through ADAMS, where it will be made available to other relevant *Anti-Doping Organizations*.
- 7.1.5** Other circumstances in which the UIM shall take responsibility for conducting *Results Management* in respect of anti-doping rule violations involving *Athletes* and other *Persons* under its authority shall be determined by reference to and in accordance with Article 7 of the *Code*.
- 7.1.6** WADA may direct the UIM to conduct *Results Management* in particular circumstances. If the UIM refuses to conduct *Results Management* within a reasonable deadline set by WADA, such refusal shall be considered an act of non-compliance, and WADA may direct another *Anti-Doping Organization* with authority over the *Athlete* or other *Person*, that is willing to do so, to take *Results Management* responsibility in place of the UIM or, if there is no such *Anti-Doping Organization*, any other *Anti-Doping Organization* that is willing

---

*WADA would not, of course, unilaterally take possession of Samples or analytical data without good cause related to a potential anti-doping rule violation, non-compliance by a Signatory or doping activities by another Person. However, the decision as to whether good cause exists is for WADA to make in its discretion and shall not be subject to challenge. In particular, whether there is good cause or not shall not be a defense against an anti-doping rule violation or its Consequences.]*

to do so. In such case, the UIM shall reimburse the costs and attorney's fees of conducting *Results Management* to the other *Anti-Doping Organization* designated by WADA, and a failure to reimburse costs and attorney's fees shall be considered an act of non-compliance.

## **7.2 Review and Notification Regarding Potential Anti-Doping Rule Violations**

The UIM shall carry out the review and notification with respect to any potential anti-doping rule violation in accordance with the *International Standard for Results Management*.

## **7.3 Identification of Prior Anti-Doping Rule Violations**

Before giving an *Athlete* or other *Person* notice of a potential anti-doping rule violation as provided above, the UIM shall refer to ADAMS and contact WADA and other relevant *Anti-Doping Organizations* to determine whether any prior anti-doping rule violation exists.

## **7.4 Provisional Suspensions**<sup>33</sup>

### **7.4.1 Mandatory *Provisional Suspension* after an *Adverse Analytical Finding* or *Adverse Passport Finding***

If the UIM receives an *Adverse Analytical Finding* or an *Adverse Passport Finding* (upon completion of the *Adverse Passport Finding* review process) for a *Prohibited Substance* or a *Prohibited Method* that is not a *Specified Substance* or a *Specified Method*, the UIM shall impose a *Provisional Suspension* on the *Athlete* promptly upon or after the review and notification required by Article 7.2.

A mandatory *Provisional Suspension* may be eliminated if: (i) the *Athlete* demonstrates to the UIM Anti-Doping Hearing Panel that the violation is likely to have involved a *Contaminated Product*, or (ii) the violation involves a *Substance of Abuse* and the *Athlete* establishes entitlement to a reduced period of *Ineligibility* under Article 10.2.4.1.

The UIM Anti-Doping Hearing Panel's decision not to eliminate a mandatory *Provisional Suspension* on account of the *Athlete's* assertion regarding a *Contaminated Product* shall not be appealable.

### **7.4.2 Optional *Provisional Suspension* Based on an *Adverse Analytical Finding* for *Specified Substances*, *Specified Methods*, *Contaminated Products*, or Other Anti-Doping Rule Violations**

The UIM may impose a *Provisional Suspension* for anti-doping rule violations not covered by Article 7.4.1 prior to the analysis of the *Athlete's* B *Sample* or final hearing as described in Article 8.

An optional *Provisional Suspension* may be lifted at the discretion of the UIM at any time prior to the UIM Anti-Doping Hearing Panel's decision under Article 8, unless provided otherwise in the *International Standard for Results Management*.

### **7.4.3 Opportunity for Hearing or Appeal**

Notwithstanding Articles 7.4.1 and 7.4.2, a *Provisional Suspension* may not be imposed unless the *Athlete* or other *Person* is given: (a) an opportunity for a *Provisional Hearing*, either before or on a timely basis after imposition of the *Provisional Suspension*; or (b) an opportunity for an expedited hearing in accordance with Article 8 on a timely basis after imposition of the *Provisional Suspension*.

<sup>33</sup> [Comment to Article 7.4: Before a *Provisional Suspension* can be unilaterally imposed by the UIM, the internal review specified in these *Anti-Doping Rules* and the *International Standard for Results Management* must first be completed.]

The imposition of a *Provisional Suspension*, or the decision not to impose a *Provisional Suspension*, may be appealed in an expedited process in accordance with Article 13.2.

#### 7.4.4 Voluntary Acceptance of *Provisional Suspension*

*Athletes* on their own initiative may voluntarily accept a *Provisional Suspension* if done so prior to the later of: (i) the expiration of ten (10) days from the report of the B *Sample* (or waiver of the B *Sample*) or ten (10) days from the notice of any other anti-doping rule violation, or (ii) the date on which the *Athlete* first competes after such report or notice.

Other *Persons* on their own initiative may voluntarily accept a *Provisional Suspension* if done so within ten (10) days from the notice of the anti-doping rule violation.

Upon such voluntary acceptance, the *Provisional Suspension* shall have the full effect and be treated in the same manner as if the *Provisional Suspension* had been imposed under Article 7.4.1 or 7.4.2; provided, however, at any time after voluntarily accepting a *Provisional Suspension*, the *Athlete* or other *Person* may withdraw such acceptance, in which event the *Athlete* or other *Person* shall not receive any credit for time previously served during the *Provisional Suspension*.

- 7.4.5 If a *Provisional Suspension* is imposed based on an A *Sample Adverse Analytical Finding* and a subsequent B *Sample* analysis (if requested by the *Athlete* or the UIM) does not confirm the A *Sample* analysis, then the *Athlete* shall not be subject to any further *Provisional Suspension* on account of a violation of Article 2.1. In circumstances where the *Athlete* (or the *Athlete's* team has been removed from an *Event* based on a violation of Article 2.1 and the subsequent B *Sample* analysis does not confirm the A *Sample* finding, then, if it is still possible for the *Athlete* or team to be reinserted, without otherwise affecting the *Event*, the *Athlete* or team may continue to take part in the *Event*.

## **7.5 Results Management Decisions**

*Results Management* decisions or adjudications by the UIM must not purport to be limited to a particular geographic area or the the UIM's sport and shall address and determine without limitation the following issues: (i) whether an anti-doping rule violation was committed or a *Provisional Suspension* should be imposed, the factual basis for such determination, and the specific Articles that have been violated, and (ii) all *Consequences* flowing from the anti-doping rule violation(s), including applicable *Disqualifications* under Articles 9 and 10.10, any forfeiture of medals or prizes, any period of *Ineligibility* (and the date it begins to run) and any *Financial Consequences*.<sup>34</sup>

## **7.6 Notification of Results Management Decisions**

The UIM shall notify *Athletes*, other *Persons*, *Signatories* and WADA of *Results Management* decisions as provided in Article 14.2 and in the *International Standard for Results Management*.

<sup>34</sup> [Comment to Article 7.5: *Results Management* decisions include *Provisional Suspensions*.

*Each decision by the UIM should address whether an anti-doping rule violation was committed and all Consequences flowing from the violation, including any Disqualifications other than Disqualification under Article 10.1 (which is left to the ruling body for an Event). Pursuant to Article 15, such decision and its imposition of Consequences shall have automatic effect in every sport in every country. For example, for a determination that an Athlete committed an anti-doping rule violation based on an Adverse Analytical Finding for a Sample taken In-Competition, the Athlete's results obtained in the Competition would be Disqualified under Article 9 and all other competitive results obtained by the Athlete from the date the Sample was collected through the duration of the period of Ineligibility are also Disqualified under Article 10.10; if the Adverse Analytical Finding resulted from Testing at an Event, it would be the Major Event Organization's responsibility to decide whether the Athlete's other individual results in the Event prior to Sample collection are also Disqualified under Article 10.1.]*



## **7.7 Retirement from Sport**<sup>35</sup>

If an *Athlete* or other *Person* retires while the the UIM's *Results Management* process is underway, the UIM retains authority to complete its *Results Management* process. If an *Athlete* or other *Person* retires before any *Results Management* process has begun, and the UIM would have had *Results Management* authority over the *Athlete* or other *Person* at the time the *Athlete* or other *Person* committed an anti-doping rule violation, the UIM has authority to conduct *Results Management*.

## **ARTICLE 8 RESULTS MANAGEMENT: RIGHT TO A FAIR HEARING AND NOTICE OF HEARING DECISION**

For any *Person* who is asserted to have committed an anti-doping rule violation, the UIM shall provide a fair hearing within a reasonable time by a fair, impartial and *Operationally Independent* hearing panel in compliance with the *Code* and the *International Standard for Results Management*.

### **8.1 Fair Hearings**

#### **8.1.1 Fair, Impartial and *Operationally Independent* Hearing Panel**

- 8.1.1.1** The UIM shall establish a Hearing Panel [the UIM Anti-Doping Hearing Panel] which has jurisdiction to hear and determine whether an *Athlete* or other *Person*, subject to these Anti-Doping Rules, has committed an anti-doping rule violation and, if applicable, to impose relevant *Consequences*.
- 8.1.1.2** The UIM shall ensure that the UIM Anti-Doping Hearing Panel is free of conflict of interest and that its composition, term of office, professional experience, *Operational Independence* and adequate financing comply with the requirements of the *International Standard for Results Management*.
- 8.1.1.3** Board members, staff members, commission members, consultants and officials of the UIM or its affiliates (e.g. *National Authorities* or confederation), as well as any *Person* involved in the investigation and pre-adjudication of the matter, cannot be appointed as members and/or clerks (to the extent that such clerk is involved in the deliberation process and/or drafting of any decision) of the UIM Anti-Doping Hearing Panel. In particular, no member shall have previously considered any *TUE* application, *Results Management* decision, or appeals in the same given case.
- 8.1.1.4** The UIM Anti-Doping Hearing Panel shall consist of an independent Chair and two (2) other independent members.
- 8.1.1.5** Each member shall be appointed by taking into consideration their requisite anti-doping experience including their legal, sports,

<sup>35</sup> [Comment to Article 7.7: Conduct by an *Athlete* or other *Person* before the *Athlete* or other *Person* was subject to the authority of any Anti-Doping Organization would not constitute an anti-doping rule violation but could be a legitimate basis for denying the *Athlete* or other *Person* membership in a sports organization.]

medical and/or scientific expertise. Each member shall be appointed for a once renewable term of three (3) years.

- 8.1.1.6** The UIM Anti-Doping Hearing Panel shall be in a position to conduct the hearing and decision-making process without interference from the UIM or any third party.

## **8.1.2** Hearing Process

- 8.1.2.1** When the UIM sends a notice to an *Athlete* or other *Person* notifying them of a potential anti-doping rule violation, and the *Athlete* or other *Person* does not waive a hearing in accordance with Article 8.3.1 or Article 8.3.2, then the case shall be referred to the UIM Anti-Doping Hearing Panel for hearing and adjudication, which shall be conducted in accordance with the principles described in Articles 8 and 9 of the *International Standard for Results Management*.

- 8.1.2.2** The Chair shall appoint three (3) members (which may include the Chair) to hear that case. When hearing a case, one (1) panel member shall be a qualified lawyer, with no less than three (3) years of relevant legal experience, and one (1) panel member shall be a qualified medical practitioner, with no less than three (3) years of relevant medical experience.

- 8.1.2.3** Upon appointment by the Chair as a member of the UIM Anti-Doping Hearing Panel, each member must also sign a declaration that there are no facts or circumstances known to him or her which might call into question their impartiality in the eyes of any of the parties, other than those circumstances disclosed in the declaration.

- 8.1.2.4** Hearings held in connection with *Events* in respect to *Athletes* and other *Persons* who are subject to these Anti-Doping Rules may be conducted by an expedited process where permitted by the the UIM Anti-Doping Hearing Panel.<sup>36</sup>

- 8.1.2.5** WADA, the *National Authority* and the *National Anti-Doping Organization* of the *Athlete* or other *Person* may attend the hearing as observers. In any event, the UIM shall keep them fully apprised as to the status of pending cases and the result of all hearings.

## **8.2** Notice of Decisions

- 8.2.1** At the end of the hearing, or promptly thereafter, the UIM Anti-Doping Hearing Panel shall issue a written decision that conforms with Article 9 of the *International Standard for Results Management* and which includes the full reasons for the decision, the period of *Ineligibility* imposed, the *Disqualification* of results under Article 10.10 and, if applicable, a justification for why the greatest potential *Consequences* were not imposed.

- 8.2.2** The UIM shall notify that decision to the *Athlete* or other *Person* and to other *Anti-Doping Organizations* with a right to appeal under Article 13.2.3, and shall promptly report it into ADAMS. The decision may be appealed as provided in Article 13.

## **8.3** Waiver of Hearing

<sup>36</sup> [Comment to Article 8.1.2.4: For example, a hearing could be expedited on the eve of a major Event where the resolution of the anti-doping rule violation is necessary to determine the Athlete's eligibility to participate in the Event, or during an Event where the resolution of the case will affect the validity of the Athlete's results or continued participation in the Event.]

- 8.3.1** An *Athlete* or other *Person* against whom an anti-doping violation is asserted may waive a hearing expressly and agree with the *Consequences* proposed by the UIM.
- 8.3.2** However, if the *Athlete* or other *Person* against whom an anti-doping rule violation is asserted fails to dispute that assertion within twenty (20) days or the deadline otherwise specified in the notice sent by the the UIM asserting the violation, then they shall be deemed to have waived a hearing, to have admitted the violation, and to have accepted the proposed *Consequences*.
- 8.3.3** In cases where Article 8.3.1 or 8.3.2 applies, a hearing before the UIM Anti-Doping Hearing Panel shall not be required. Instead the UIM shall promptly issue a written decision that conforms with Article 9 of the *International Standard for Results Management* and which includes the full reasons for the decision, the period of *Ineligibility* imposed, the *Disqualification* of results under Article 10.10 and, if applicable, a justification for why the greatest potential *Consequences* were not imposed.
- 8.3.4** The UIM shall notify that decision to the *Athlete* or other *Person* and to other *Anti-Doping Organizations* with a right to appeal under Article 13.2.3, and shall promptly report it into ADAMS. the UIM shall *Publicly Disclose* that decision in accordance with Article 14.3.2.

#### **8.4 Single Hearing Before CAS**

Anti-doping rule violations asserted against *International-Level Athletes*, *National-Level Athletes* or other *Persons* may, with the consent of the *Athlete* or other *Person*, the UIM (where it has *Results Management* responsibility in accordance with Article 7) and WADA, be heard in a single hearing directly at CAS.<sup>37</sup>

### **ARTICLE 9 AUTOMATIC DISQUALIFICATION OF INDIVIDUAL RESULTS**

An anti-doping rule violation in *Individual Sports* in connection with an *In-Competition* test automatically leads to *Disqualification* of the result obtained in that *Competition* with all resulting *Consequences*, including forfeiture of any medals, points and prizes.<sup>40</sup>

### **ARTICLE 10 SANCTIONS ON INDIVIDUALS**

#### **10.1 Disqualification of Results in the Event during which an Anti-Doping Rule Violation Occurs**

- 10.1.1** An anti-doping rule violation occurring during or in connection with an *Event* may, upon the decision of the ruling body of the *Event*, lead to *Disqualification* of all of the *Athlete's* individual results obtained in that *Event*

<sup>37</sup> [Comment to Article 8.4: In some cases, the combined cost of holding a hearing in the first instance at the international or national level, then rehearing the case de novo before CAS can be very substantial. Where all of the parties identified in this Article are satisfied that their interests will be adequately protected in a single hearing, there is no need for the *Athlete* or *Anti-Doping Organizations* to incur the extra expense of two (2) hearings. An *Anti-Doping Organization* may participate in the CAS hearing as an observer. Nothing set out in Article 8.4 precludes the *Athlete* or other *Person* and the UIM (where it has *Results Management* responsibility) to waive their right to appeal by agreement. Such waiver, however, only binds the parties to such agreement and not any other entity with a right of appeal under the Code.]

<sup>40</sup> [Comment to Article 9: For *Team Sports*, any awards received by individual players will be *Disqualified*. However, *Disqualification* of the team will be as provided in Article 11. In sports which are not *Team Sports* but where awards are given to teams, *Disqualification* or other disciplinary action against the team when one or more team members have committed an anti-doping rule violation shall be as provided in the applicable rules of the *International Federation*.]

with all *Consequences*, including forfeiture of all medals, points and prizes, except as provided in Article 10.1.2.

Factors to be included in considering whether to *Disqualify* other results in an *Event* might include, for example, the seriousness of the *Athlete's* anti-doping rule violation and whether the *Athlete* tested negative in the other *Competitions*.<sup>41</sup>

- 10.1.2** If the *Athlete* establishes that he or she bears *No Fault or Negligence* for the violation, the *Athlete's* individual results in the other *Competitions* shall not be *Disqualified*, unless the *Athlete's* results in *Competitions* other than the *Competition* in which the anti-doping rule violation occurred were likely to have been affected by the *Athlete's* anti-doping rule violation.

## **10.2 Ineligibility for Presence, Use or Attempted Use, or Possession of a Prohibited Substance or Prohibited Method**

The period of *Ineligibility* for a violation of Article 2.1, 2.2 or 2.6 shall be as follows, subject to potential elimination, reduction or suspension pursuant to Article 10.5, 10.6 or 10.7:

- 10.2.1** The period of *Ineligibility*, subject to Article 10.2.4, shall be four (4) years where:
- 10.2.1.1** The anti-doping rule violation does not involve a *Specified Substance* or a *Specified Method*, unless the *Athlete* or other *Person* can establish that the anti-doping rule violation was not intentional.<sup>42</sup>
- 10.2.1.2** The anti-doping rule violation involves a *Specified Substance* or a *Specified Method* and the UIM can establish that the anti-doping rule violation was intentional.
- 10.2.2** If Article 10.2.1 does not apply, subject to Article 10.2.4.1, the period of *Ineligibility* shall be two (2) years.
- 10.2.3** As used in Article 10.2, the term "intentional" is meant to identify those *Athletes* or other *Persons* who engage in conduct which they knew constituted an anti-doping rule violation or knew that there was a significant risk that the conduct might constitute or result in an anti-doping rule violation and manifestly disregarded that risk. An anti-doping rule violation resulting from an *Adverse Analytical Finding* for a substance which is only prohibited *In-Competition* shall be rebuttably presumed to be not "intentional" if the substance is a *Specified Substance* and the *Athlete* can establish that the *Prohibited Substance* was *Used Out-of-Competition*. An anti-doping rule violation resulting from an *Adverse Analytical Finding* for a substance which is only prohibited *In-Competition* shall not be considered "intentional" if the substance is not a *Specified Substance* and the *Athlete* can establish that the *Prohibited Substance* was *Used Out-of-Competition* in a context unrelated to sport performance.<sup>43</sup>

<sup>41</sup> [Comment to Article 10.1.1: Whereas Article 9 Disqualifies the result in a single Competition in which the Athlete tested positive (e.g., the 100 meter backstroke), this Article may lead to Disqualification of all results in all races during the Event (e.g., the swimming World Championships).]

<sup>42</sup> [Comment to Article 10.2.1.1: While it is theoretically possible for an Athlete or other Person to establish that the anti-doping rule violation was not intentional without showing how the Prohibited Substance entered one's system, it is highly unlikely that in a doping case under Article 2.1 an Athlete will be successful in proving that the Athlete acted unintentionally without establishing the source of the Prohibited Substance.]

<sup>43</sup> [Comment to Article 10.2.3: Article 10.2.3 provides a special definition of "intentional" which is to be applied solely for purposes of Article 10.2.]

**10.2.4** Notwithstanding any other provision in Article 10.2, where the anti-doping rule violation involves a *Substance of Abuse*:

**10.2.4.1** If the *Athlete* can establish that any ingestion or *Use* occurred *Out-of-Competition* and was unrelated to sport performance, then the period of *Ineligibility* shall be three (3) months *Ineligibility*.

In addition, the period of *Ineligibility* calculated under this Article 10.2.4.1 may be reduced to one (1) month if the *Athlete* or other *Person* satisfactorily completes a *Substance of Abuse* treatment program approved by the UIM. The period of *Ineligibility* established in this Article 10.2.4.1 is not subject to any reduction based on any provision in Article 10.6.<sup>44</sup>

**10.2.4.2** If the ingestion, *Use* or *Possession* occurred *In-Competition*, and the *Athlete* can establish that the context of the ingestion, *Use* or *Possession* was unrelated to sport performance, then the ingestion, *Use* or *Possession* shall not be considered intentional for purposes of Article 10.2.1 and shall not provide a basis for a finding of *Aggravating Circumstances* under Article 10.4.

### **10.3 Ineligibility for Other Anti-Doping Rule Violations**

The period of *Ineligibility* for anti-doping rule violations other than as provided in Article 10.2 shall be as follows, unless Article 10.6 or 10.7 are applicable:

**10.3.1** For violations of Article 2.3 or 2.5, the period of *Ineligibility* shall be four (4) years except: (i) in the case of failing to submit to *Sample* collection, if the *Athlete* can establish that the commission of the anti-doping rule violation was not intentional, the period of *Ineligibility* shall be two (2) years; (ii) in all other cases, if the *Athlete* or other *Person* can establish exceptional circumstances that justify a reduction of the period of *Ineligibility*, the period of *Ineligibility* shall be in a range from two (2) years to four (4) years depending on the *Athlete* or other *Person's* degree of *Fault*; or (iii) in a case involving a *Protected Person* or *Recreational Athlete*, the period of *Ineligibility* shall be in a range between a maximum of two (2) years and, at a minimum, a reprimand and no period of *Ineligibility*, depending on the *Protected Person* or *Recreational Athlete's* degree of *Fault*.

**10.3.2** For violations of Article 2.4, the period of *Ineligibility* shall be two (2) years, subject to reduction down to a minimum of one (1) year, depending on the *Athlete's* degree of *Fault*. The flexibility between two (2) years and one (1) year of *Ineligibility* in this Article is not available to *Athletes* where a pattern of last-minute whereabouts changes or other conduct raises a serious suspicion that the *Athlete* was trying to avoid being available for *Testing*.

**10.3.3** For violations of Article 2.7 or 2.8, the period of *Ineligibility* shall be a minimum of four (4) years up to lifetime *Ineligibility*, depending on the seriousness of the violation. An Article 2.7 or Article 2.8 violation involving a *Protected Person* shall be considered a particularly serious violation and, if committed by *Athlete Support Personnel* for violations other than for *Specified Substances*, shall result in lifetime *Ineligibility* for *Athlete Support Personnel*. In addition, significant violations of Article 2.7 or 2.8 which may also violate non-sporting laws and regulations, shall be reported to the competent administrative, professional or judicial authorities.<sup>45</sup>

<sup>44</sup> [Comment to Article 10.2.4.1: The determinations as to whether the treatment program is approved and whether the *Athlete* or other *Person* has satisfactorily completed the program shall be made in the sole discretion of the UIM. This Article is intended to give the UIM the leeway to apply their own judgment to identify and approve legitimate and reputable, as opposed to "sham", treatment programs. It is anticipated, however, that the characteristics of legitimate treatment programs may vary widely and change over time such that it would not be practical for WADA to develop mandatory criteria for acceptable treatment programs.]

<sup>45</sup> [Comment to Article 10.3.3: Those who are involved in doping *Athletes* or covering up doping should be subject to sanctions

- 10.3.4** For violations of Article 2.9, the period of *Ineligibility* imposed shall be a minimum of two (2) years, up to lifetime *Ineligibility*, depending on the seriousness of the violation.
- 10.3.5** For violations of Article 2.10, the period of *Ineligibility* shall be two (2) years, subject to reduction down to a minimum of one (1) year, depending on the *Athlete* or other *Person's* degree of *Fault* and other circumstances of the case.<sup>46</sup>
- 10.3.6** For violations of Article 2.11, the period of *Ineligibility* shall be a minimum of two (2) years, up to lifetime *Ineligibility*, depending on the seriousness of the violation by the *Athlete* or other *Person*.<sup>47</sup>

#### **10.4 Aggravating Circumstances which may Increase the Period of Ineligibility**

If the UIM establishes in an individual case involving an anti-doping rule violation other than violations under Article 2.7 (*Trafficking or Attempted Trafficking*), 2.8 (*Administration or Attempted Administration*), 2.9 (*Complicity*) or 2.11 (*Acts by an Athlete or Other Person to Discourage or Retaliate Against Reporting*) that *Aggravating Circumstances* are present which justify the imposition of a period of *Ineligibility* greater than the standard sanction, then the period of *Ineligibility* otherwise applicable shall be increased by an additional period of *Ineligibility* of up to two (2) years depending on the seriousness of the violation and the nature of the *Aggravating Circumstances*, unless the *Athlete* or other *Person* can establish that he or she did not knowingly commit the anti-doping rule violation.<sup>48</sup>

#### **10.5 Elimination of the Period of Ineligibility where there is No Fault or Negligence**

If an *Athlete* or other *Person* establishes in an individual case that he or she bears *No Fault* or *Negligence*, then the otherwise applicable period of *Ineligibility* shall be eliminated.<sup>49</sup>

#### **10.6 Reduction of the Period of Ineligibility based on No Significant Fault or Negligence**

*which are more severe than the Athletes who test positive. Since the authority of sport organizations is generally limited to Ineligibility for accreditation, membership and other sport benefits, reporting Athlete Support Personnel to competent authorities is an important step in the deterrence of doping.]*

<sup>46</sup> [Comment to Article 10.3.5: Where the "other Person" referenced in Article 2.10 is an entity and not an individual, that entity may be disciplined as provided in Article 12.]

<sup>47</sup> [Comment to Article 10.3.6: Conduct that is found to violate both Article 2.5 (*Tampering*) and Article 2.11 (*Acts by an Athlete or Other Person to Discourage or Retaliate Against Reporting to Authorities*) shall be sanctioned based on the violation that carries the more severe sanction.]

<sup>48</sup> [Comment to Article 10.4: Violations under Articles 2.7 (*Trafficking or Attempted Trafficking*), 2.8 (*Administration or Attempted Administration*), 2.9 (*Complicity or Attempted Complicity*) and 2.11 (*Acts by an Athlete or Other Person to Discourage or Retaliate Against Reporting to Authorities*) are not included in the application of Article 10.4 because the sanctions for these violations already build in sufficient discretion up to a lifetime ban to allow consideration of any *Aggravating Circumstance*.]

<sup>49</sup> [Comment to Article 10.5: This Article and Article 10.6.2 apply only to the imposition of sanctions: they are not applicable to the determination of whether an anti-doping rule violation has occurred. They will only apply in exceptional circumstances, for example, where an *Athlete* could prove that, despite all due care, he or she was sabotaged by a competitor. Conversely, *No Fault or Negligence* would not apply in the following circumstances: (a) a positive test resulting from a mislabeled or contaminated vitamin or nutritional supplement (*Athletes* are responsible for what they ingest (Article 2.1) and have been warned against the possibility of supplement contamination); (b) the *Administration* of a *Prohibited Substance* by the *Athlete's* personal physician or trainer without disclosure to the *Athlete* (*Athletes* are responsible for their choice of medical personnel and for advising medical personnel that they cannot be given any *Prohibited Substance*); and (c) sabotage of the *Athlete's* food or drink by a spouse, coach or other *Person* within the *Athlete's* circle of associates (*Athletes* are responsible for what they ingest and for the conduct of those *Persons* to whom they entrust access to their food and drink). However, depending on the unique facts of a particular case, any of the referenced illustrations could result in a reduced sanction under Article 10.6 based on *No Significant Fault or Negligence*.]

### 10.6.1 Reduction of Sanctions in Particular Circumstances for Violations of Article 2.1, 2.2 or 2.6.

All reductions under Article 10.6.1 are mutually exclusive and not cumulative.

#### 10.6.1.1 Specified Substances or Specified Methods

Where the anti-doping rule violation involves a *Specified Substance* (other than a *Substance of Abuse*) or *Specified Method*, and the *Athlete* or other *Person* can establish *No Significant Fault or Negligence*, then the period of *Ineligibility* shall be, at a minimum, a reprimand and no period of *Ineligibility*, and at a maximum, two (2) years of *Ineligibility*, depending on the *Athlete's* or other *Person's* degree of *Fault*.

#### 10.6.1.2 Contaminated Products

In cases where the *Athlete* or other *Person* can establish both *No Significant Fault or Negligence* and that the detected *Prohibited Substance* (other than a *Substance of Abuse*) came from a *Contaminated Product*, then the period of *Ineligibility* shall be, at a minimum, a reprimand and no period of *Ineligibility*, and at a maximum, two (2) years *Ineligibility*, depending on the *Athlete* or other *Person's* degree of *Fault*.<sup>50</sup>

#### 10.6.1.3 Protected Persons or Recreational Athletes

Where the anti-doping rule violation not involving a *Substance of Abuse* is committed by a *Protected Person* or *Recreational Athlete*, and the *Protected Person* or *Recreational Athlete* can establish *No Significant Fault or Negligence*, then the period of *Ineligibility* shall be, at a minimum, a reprimand and no period of *Ineligibility*, and at a maximum, two (2) years *Ineligibility*, depending on the *Protected Person* or *Recreational Athlete's* degree of *Fault*.

### 10.6.2 Application of *No Significant Fault or Negligence* beyond the Application of Article 10.6.1

If an *Athlete* or other *Person* establishes in an individual case where Article 10.6.1 is not applicable that he or she bears *No Significant Fault or Negligence*, then, subject to further reduction or elimination as provided in Article 10.7, the otherwise applicable period of *Ineligibility* may be reduced based on the *Athlete* or other *Person's* degree of *Fault*, but the reduced period of *Ineligibility* may not be less than one-half of the period of *Ineligibility* otherwise applicable. If the otherwise applicable period of *Ineligibility* is a lifetime, the reduced period under this Article may be no less than eight (8) years.<sup>51</sup>

<sup>50</sup> [Comment to Article 10.6.1.2: In order to receive the benefit of this Article, the *Athlete* or other *Person* must establish not only that the detected *Prohibited Substance* came from a *Contaminated Product*, but must also separately establish *No Significant Fault or Negligence*. It should be further noted that *Athletes* are on notice that they take nutritional supplements at their own risk. The sanction reduction based on *No Significant Fault or Negligence* has rarely been applied in *Contaminated Product* cases unless the *Athlete* has exercised a high level of caution before taking the *Contaminated Product*. In assessing whether the *Athlete* can establish the source of the *Prohibited Substance*, it would, for example, be significant for purposes of establishing whether the *Athlete* actually Used the *Contaminated Product*, whether the *Athlete* had declared the product which was subsequently determined to be contaminated on the *Doping Control* form.

This Article should not be extended beyond products that have gone through some process of manufacturing. Where an *Adverse Analytical Finding* results from environment contamination of a "non-product" such as tap water or lake water in circumstances where no reasonable person would expect any risk of an anti-doping rule violation, typically there would be *No Fault or Negligence* under Article 10.5.]

<sup>51</sup> [Comment to Article 10.6.2: Article 10.6.2 may be applied to any anti-doping rule violation except those Articles where intent

## **10.7 Elimination, Reduction, or Suspension of Period of Ineligibility or Other Consequences for Reasons Other than Fault**

### **10.7.1 Substantial Assistance in Discovering or Establishing Code Violations<sup>52</sup>**

**10.7.1.1** The UIM may, prior to an appellate decision under Article 13 or the expiration of the time to appeal, suspend a part of the *Consequences* (other than *Disqualification* and mandatory *Public Disclosure*) imposed in an individual case where the *Athlete* or other *Person* has provided *Substantial Assistance* to an *Anti-Doping Organization*, criminal authority or professional disciplinary body which results in: (i) the *Anti-Doping Organization* discovering or bringing forward an anti-doping rule violation by another *Person*; or (ii) which results in a criminal or disciplinary body discovering or bringing forward a criminal offense or the breach of professional rules committed by another *Person* and the information provided by the *Person* providing *Substantial Assistance* is made available to the UIM or other *Anti-Doping Organization* with *Results Management* responsibility; or (iii) which results in WADA initiating a proceeding against a *Signatory*, WADA-accredited laboratory, or *Athlete* passport management unit (as defined in the *International Standard for Laboratories*) for non-compliance with the *Code*, *International Standard* or *Technical Document*; or (iv) with the approval by WADA, which results in a criminal or disciplinary body bringing forward a criminal offense or the breach of professional or sport rules arising out of a sport integrity violation other than doping. After an appellate decision under Article 13 or the expiration of time to appeal, the UIM may only suspend a part of the otherwise applicable *Consequences* with the approval of WADA.

The extent to which the otherwise applicable period of *Ineligibility* may be suspended shall be based on the seriousness of the anti-doping rule violation committed by the *Athlete* or other *Person* and the significance of the *Substantial Assistance* provided by the *Athlete* or other *Person* to the effort to eliminate doping in sport, non-compliance with the *Code* and/or sport integrity violations. No more than three-quarters of the otherwise applicable period of *Ineligibility* may be suspended. If the otherwise applicable period of *Ineligibility* is a lifetime, the non-suspended period under this Article must be no less than eight (8) years. For purposes of this paragraph, the otherwise applicable period of *Ineligibility* shall not include any period of *Ineligibility* that could be added under Article 10.9.3.2 of these Anti-Doping Rules.

If so requested by an *Athlete* or other *Person* who seeks to provide *Substantial Assistance*, the UIM shall allow the *Athlete* or other *Person* to provide the information to it subject to a *Without Prejudice Agreement*.

If the *Athlete* or other *Person* fails to continue to cooperate and to provide the complete and credible *Substantial Assistance* upon which a suspension of *Consequences* was based, the UIM shall reinstate the original *Consequences*. If the UIM decides to reinstate suspended *Consequences* or decides not to reinstate

---

*is an element of the anti-doping rule violation (e.g., Article 2.5, 2.7, 2.8, 2.9 or 2.11) or an element of a particular sanction (e.g., Article 10.2.1) or a range of Ineligibility is already provided in an Article based on the Athlete or other Person's degree of Fault.]*

<sup>52</sup> [Comment to Article 10.7.1: The cooperation of Athletes, Athlete Support Personnel and other Persons who acknowledge their mistakes and are willing to bring other anti-doping rule violations to light is important to clean sport.]



suspended *Consequences*, that decision may be appealed by any *Person* entitled to appeal under Article 13.

**10.7.1.2** To further encourage *Athletes* and other *Persons* to provide *Substantial Assistance* to *Anti-Doping Organizations*, at the request of the UIM or at the request of the *Athlete* or other *Person* who has, or has been asserted to have, committed an anti-doping rule violation, or other violation of the *Code*, *WADA* may agree at any stage of the *Results Management* process, including after an appellate decision under Article 13, to what it considers to be an appropriate suspension of the otherwise-applicable period of *Ineligibility* and other *Consequences*. In exceptional circumstances, *WADA* may agree to suspensions of the period of *Ineligibility* and other *Consequences* for *Substantial Assistance* greater than those otherwise provided in this Article, or even no period of *Ineligibility*, no mandatory *Public Disclosure* and/or no return of prize money or payment of fines or costs. *WADA*'s approval shall be subject to reinstatement of *Consequences*, as otherwise provided in this Article. Notwithstanding Article 13, *WADA*'s decisions in the context of this Article 10.7.1.2 may not be appealed.

**10.7.1.3** If the UIM suspends any part of an otherwise applicable sanction because of *Substantial Assistance*, then notice providing justification for the decision shall be provided to the other *Anti-Doping Organizations* with a right to appeal under Article 13.2.3 as provided in Article 14.2. In unique circumstances where *WADA* determines that it would be in the best interest of anti-doping, *WADA* may authorize the UIM to enter into appropriate confidentiality agreements limiting or delaying the disclosure of the *Substantial Assistance* agreement or the nature of *Substantial Assistance* being provided.

**10.7.2** Admission of an Anti-Doping Rule Violation in the Absence of Other Evidence

Where an *Athlete* or other *Person* voluntarily admits the commission of an anti-doping rule violation before having received notice of a *Sample* collection which could establish an anti-doping rule violation (or, in the case of an anti-doping rule violation other than Article 2.1, before receiving first notice of the admitted violation pursuant to Article 7) and that admission is the only reliable evidence of the violation at the time of admission, then the period of *Ineligibility* may be reduced, but not below one-half of the period of *Ineligibility* otherwise applicable.<sup>53</sup>

**10.7.3** Application of Multiple Grounds for Reduction of a Sanction

Where an *Athlete* or other *Person* establishes entitlement to reduction in sanction under more than one provision of Article 10.5, 10.6 or 10.7, before applying any reduction or suspension under Article 10.7, the otherwise applicable period of *Ineligibility* shall be determined in accordance with Articles 10.2, 10.3, 10.5, and 10.6. If the *Athlete* or other *Person* establishes entitlement to a reduction or suspension of the period of *Ineligibility* under Article 10.7, then the period of *Ineligibility* may be reduced or suspended, but not below one-fourth of the otherwise applicable period of *Ineligibility*.

## **10.8 Results Management Agreements**

<sup>53</sup> [Comment to Article 10.7.2: This Article is intended to apply when an *Athlete* or other *Person* comes forward and admits to an anti-doping rule violation in circumstances where no *Anti-Doping Organization* is aware that an anti-doping rule violation might have been committed. It is not intended to apply to circumstances where the admission occurs after the *Athlete* or other *Person* believes he or she is about to be caught. The amount by which *Ineligibility* is reduced should be based on the likelihood that the *Athlete* or other *Person* would have been caught had he or she not come forward voluntarily.]

### 10.8.1 One (1) Year Reduction for Certain Anti-Doping Rule Violations Based on Early Admission and Acceptance of Sanction

Where an *Athlete* or other *Person*, after being notified by the UIM of a potential anti-doping rule violation that carries an asserted period of *Ineligibility* of four (4) or more years (including any period of *Ineligibility* asserted under Article 10.4), admits the violation and accepts the asserted period of *Ineligibility* no later than twenty (20) days after receiving notice of an anti-doping rule violation charge, the *Athlete* or other *Person* may receive a one (1) year reduction in the period of *Ineligibility* asserted by the UIM. Where the *Athlete* or other *Person* receives the one (1) year reduction in the asserted period of *Ineligibility* under this Article 10.8.1, no further reduction in the asserted period of *Ineligibility* shall be allowed under any other Article.<sup>54</sup>

### 10.8.2 Case Resolution Agreement

Where the *Athlete* or other *Person* admits an anti-doping rule violation after being confronted with the anti-doping rule violation by the UIM and agrees to *Consequences* acceptable to the UIM and WADA, at their sole discretion, then: (a) the *Athlete* or other *Person* may receive a reduction in the period of *Ineligibility* based on an assessment by the UIM and WADA of the application of Articles 10.1 through 10.7 to the asserted anti-doping rule violation, the seriousness of the violation, the *Athlete* or other *Person*'s degree of *Fault* and how promptly the *Athlete* or other *Person* admitted the violation; and (b) the period of *Ineligibility* may start as early as the date of *Sample* collection or the date on which another anti-doping rule violation last occurred. In each case, however, where this Article is applied, the *Athlete* or other *Person* shall serve at least one-half of the agreed-upon period of *Ineligibility* going forward from the earlier of the date the *Athlete* or other *Person* accepted the imposition of a sanction or a *Provisional Suspension* which was subsequently respected by the *Athlete* or other *Person*. The decision by WADA and the UIM to enter or not enter into a case resolution agreement, and the amount of the reduction to, and the starting date of, the period of *Ineligibility* are not matters for determination or review by a hearing body and are not subject to appeal under Article 13.

If so requested by an *Athlete* or other *Person* who seeks to enter into a case resolution agreement under this Article, the UIM shall allow the *Athlete* or other *Person* to discuss an admission of the anti-doping rule violation with it subject to a *Without Prejudice Agreement*.<sup>55</sup>

## 10.9 Multiple Violations

### 10.9.1 Second or Third Anti-Doping Rule Violation

10.9.1.1 For an *Athlete* or other *Person*'s second anti-doping rule violation, the period of *Ineligibility* shall be the greater of:

- (a) A six (6) month period of *Ineligibility*; or
- (b) A period of *Ineligibility* in the range between:
  - (i) the sum of the period of *Ineligibility* imposed for the first anti-doping rule violation plus the period of *Ineligibility* otherwise applicable to the second anti-doping rule violation treated as if it were a first violation, and
  - (ii) twice the period of *Ineligibility* otherwise applicable to the

<sup>54</sup> [Comment to Article 10.8.1: For example, if the UIM alleges that an *Athlete* has violated Article 2.1 for Use of an anabolic steroid and asserts the applicable period of *Ineligibility* is four (4) years, then the *Athlete* may unilaterally reduce the period of *Ineligibility* to three (3) years by admitting the violation and accepting the three (3) year period of *Ineligibility* within the time specified in this Article, with no further reduction allowed. This resolves the case without any need for a hearing.]

<sup>55</sup> [Comment to Article 10.8: Any mitigating or aggravating factors set forth in this Article 10 shall be considered in arriving at the *Consequences* set forth in the case resolution agreement, and shall not be applicable beyond the terms of that agreement.]

second anti-doping rule violation treated as if it were a first violation. The period of *Ineligibility* shall be determined based on the entirety of the circumstances and the *Athlete* or other *Person's* degree of *Fault* with respect to the second violation.

- 10.9.1.2** A third anti-doping rule violation will always result in a lifetime period of *Ineligibility*, except if the third violation fulfills the condition for elimination or reduction of the period of *Ineligibility* under Article 10.5 or 10.6, or involves a violation of Article 2.4. In these particular cases, the period of *Ineligibility* shall be from eight (8) years to lifetime *Ineligibility*.
- 10.9.1.3** The period of *Ineligibility* established in Articles 10.9.1.1 and 10.9.1.2 may then be further reduced by the application of Article 10.7.
- 10.9.2** An anti-doping rule violation for which an *Athlete* or other *Person* has established *No Fault* or *Negligence* shall not be considered a violation for purposes of this Article 10.9. In addition, an anti-doping rule violation sanctioned under Article 10.2.4.1 shall not be considered a violation for purposes of Article 10.9.
- 10.9.3** Additional Rules for Certain Potential Multiple Violations
- 10.9.3.1** For purposes of imposing sanctions under Article 10.9, except as provided in Articles 10.9.3.2 and 10.9.3.3, an anti-doping rule violation will only be considered a second violation if the UIM can establish that the *Athlete* or other *Person* committed the additional anti-doping rule violation after the *Athlete* or other *Person* received notice pursuant to Article 7, or after the UIM made reasonable efforts to give notice of the first anti-doping rule violation. If the UIM cannot establish this, the violations shall be considered together as one single first violation, and the sanction imposed shall be based on the violation that carries the more severe sanction, including the application of *Aggravating Circumstances*. Results in all *Competitions* dating back to the earlier anti-doping rule violation will be *Disqualified* as provided in Article 10.10.<sup>56</sup>
- 10.9.3.2** If the UIM establishes that an *Athlete* or other *Person* committed an additional anti-doping rule violation prior to notification, and that the additional violation occurred twelve (12) months or more before or after the first-noticed violation, then the period of *Ineligibility* for the additional violation shall be calculated as if the additional violation were a stand-alone first violation and this period of *Ineligibility* is served consecutively, rather than concurrently, with the period of *Ineligibility* imposed for the earlier-noticed violation. Where this Article 10.9.3.2 applies, the violations taken together shall constitute a single violation for purposes of Article 10.9.1.
- 10.9.3.3** If the UIM establishes that an *Athlete* or other *Person* committed a violation of Article 2.5 in connection with the *Doping Control* process for an underlying asserted anti-doping rule violation, the violation of Article 2.5 shall be treated as a stand-alone first violation and the period of *Ineligibility* for such violation shall be

<sup>56</sup> [Comment to Article 10.9.3.1: The same rule applies where, after the imposition of a sanction, the UIM discovers facts involving an anti-doping rule violation that occurred prior to notification for a first anti-doping rule violation – e.g., the UIM shall impose a sanction based on the sanction that could have been imposed if the two (2) violations had been adjudicated at the same time, including the application of *Aggravating Circumstances*.]

served consecutively, rather than concurrently, with the period of *Ineligibility*, if any, imposed for the underlying anti-doping rule violation. Where this Article 10.9.3.3 is applied, the violations taken together shall constitute a single violation for purposes of Article 10.9.1.

- 10.9.3.4** If the UIM establishes that an Athlete or other Person has committed a second or third anti-doping rule violation during a period of *Ineligibility*, the periods of *Ineligibility* for the multiple violations shall run consecutively, rather than concurrently.

**10.9.4 Multiple Anti-Doping Rule Violations during Ten (10) Year Period**

For purposes of Article 10.9, each anti-doping rule violation must take place within the same ten (10) year period in order to be considered multiple violations.

**10.10 Disqualification of Results in Competitions Subsequent to Sample Collection or Commission of an Anti-Doping Rule Violation**

In addition to the automatic *Disqualification* of the results in the *Competition* which produced the positive *Sample* under Article 9, all other competitive results of the *Athlete* obtained from the date a positive *Sample* was collected (whether *In-Competition* or *Out-of-Competition*), or other anti-doping rule violation occurred, through the commencement of any *Provisional Suspension* or *Ineligibility* period, shall, unless fairness requires otherwise, be *Disqualified* with all of the resulting *Consequences* including forfeiture of any medals, points and prizes.<sup>57</sup>

**10.11 Forfeited Prize Money**

If the UIM recovers prize money forfeited as a result of an anti-doping rule violation, it shall take reasonable measures to allocate and distribute this prize money to the *Athletes* who would have been entitled to it had the forfeiting *Athlete* not competed.<sup>58</sup>

**10.12 Financial Consequences**

- 10.12.1** Where an *Athlete* or other *Person* commits an anti-doping rule violation, the UIM may, in its discretion and subject to the principle of proportionality, elect to (a) recover from the *Athlete* or other *Person* costs associated with the anti-doping rule violation, regardless of the period of *Ineligibility* imposed and/or (b) fine the *Athlete* or other *Person* in an amount up to 5'000 Euros, only in cases where the maximum period of *Ineligibility* otherwise applicable has already been imposed.

- 10.12.2** The imposition of a financial sanction or the the UIM's recovery of costs shall not be considered a basis for reducing the *Ineligibility* or other sanction which would otherwise be applicable under these Anti-Doping Rules.

**10.13 Commencement of Ineligibility Period**

Where an *Athlete* is already serving a period of *Ineligibility* for an anti-doping rule violation, any new period of *Ineligibility* shall commence on the first day after the current period of *Ineligibility* has been served. Otherwise, except as provided below, the period of *Ineligibility* shall start on the date of the final hearing decision providing for *Ineligibility* or, if the hearing is waived or there is no hearing, on the date *Ineligibility* is accepted or otherwise imposed.

<sup>57</sup> [Comment to Article 10.10: Nothing in these Anti-Doping Rules precludes clean Athletes or other Persons who have been damaged by the actions of a Person who has committed an anti-doping rule violation from pursuing any right which they would otherwise have to seek damages from such Person.]

<sup>58</sup> [Comment to Article 10.11: This Article is not intended to impose an affirmative duty on the UIM to take any action to collect forfeited prize money. If the UIM elects not to take any action to collect forfeited prize money, it may assign its right to recover such money to the Athlete(s) who should have otherwise received the money. "Reasonable measures to allocate and distribute this prize money" could include using collected forfeited prize money as agreed upon by the UIM and its Athletes.]

### 10.13.1 Delays Not Attributable to the Athlete or other Person

Where there have been substantial delays in the hearing process or other aspects of *Doping Control*, and the *Athlete* or other *Person* can establish that such delays are not attributable to the *Athlete* or other *Person*, the UIM or the UIM Anti-Doping Hearing Panel, if applicable, may start the period of *Ineligibility* at an earlier date commencing as early as the date of *Sample* collection or the date on which another anti-doping rule violation last occurred. All competitive results achieved during the period of *Ineligibility*, including retroactive *Ineligibility*, shall be *Disqualified*.<sup>59</sup>

### 10.13.2 Credit for Provisional Suspension or Period of Ineligibility Served

- 10.13.2.1** If a *Provisional Suspension* is respected by the *Athlete* or other *Person*, then the *Athlete* or other *Person* shall receive a credit for such period of *Provisional Suspension* against any period of *Ineligibility* which may ultimately be imposed. If the *Athlete* or other *Person* does not respect a *Provisional Suspension*, then the *Athlete* or other *Person* shall receive no credit for any period of *Provisional Suspension* served. If a period of *Ineligibility* is served pursuant to a decision that is subsequently appealed, then the *Athlete* or other *Person* shall receive a credit for such period of *Ineligibility* served against any period of *Ineligibility* which may ultimately be imposed on appeal.
- 10.13.2.2** If an *Athlete* or other *Person* voluntarily accepts a *Provisional Suspension* in writing from the UIM and thereafter respects the *Provisional Suspension*, the *Athlete* or other *Person* shall receive a credit for such period of voluntary *Provisional Suspension* against any period of *Ineligibility* which may ultimately be imposed. A copy of the *Athlete* or other *Person*'s voluntary acceptance of a *Provisional Suspension* shall be provided promptly to each party entitled to receive notice of an asserted anti-doping rule violation under Article 14.1.<sup>60</sup>
- 10.13.2.3** No credit against a period of *Ineligibility* shall be given for any time period before the effective date of the *Provisional Suspension* or voluntary *Provisional Suspension* regardless of whether the *Athlete* elected not to compete or was suspended by a team.
- 10.13.2.4** In *Team Sports*, where a period of *Ineligibility* is imposed upon a team, unless fairness requires otherwise, the period of *Ineligibility* shall start on the date of the final hearing decision providing for *Ineligibility* or, if the hearing is waived, on the date *Ineligibility* is accepted or otherwise imposed. Any period of team *Provisional Suspension* (whether imposed or voluntarily accepted) shall be credited against the total period of *Ineligibility* to be served.]

## **10.14 Status During Ineligibility or Provisional Suspension**

<sup>59</sup> [Comment to Article 10.13.1: In cases of anti-doping rule violations other than under Article 2.1, the time required for an Anti-Doping Organization to discover and develop facts sufficient to establish an anti-doping rule violation may be lengthy, particularly where the Athlete or other Person has taken affirmative action to avoid detection. In these circumstances, the flexibility provided in this Article to start the sanction at an earlier date should not be used.]

<sup>60</sup> [Comment to Article 10.13.2.2: An Athlete's voluntary acceptance of a Provisional Suspension is not an admission by the Athlete and shall not be used in any way to draw an adverse inference against the Athlete.]

#### 10.14.1 Prohibition Against Participation During *Ineligibility* or *Provisional Suspension*

No *Athlete* or other *Person* who has been declared *Ineligible* or is subject to a *Provisional Suspension* may, during a period of *Ineligibility* or *Provisional Suspension*, participate in any capacity in a *Competition* or activity (other than authorized anti-doping *Education* or rehabilitation programs) authorized or organized by any *Signatory*, *Signatory's* member organization, or a club or other member organization of a *Signatory's* member organization, or in *Competitions* authorized or organized by any professional league or any international- or national-level *Event* organization or any elite or national-level sporting activity funded by a governmental agency.

An *Athlete* or other *Person* subject to a period of *Ineligibility* longer than four (4) years may, after completing four (4) years of the period of *Ineligibility*, participate as an *Athlete* in local sport events not sanctioned or otherwise under the authority of a *Code Signatory* or member of a *Code Signatory*, but only so long as the local sport event is not at a level that could otherwise qualify such *Athlete* or other *Person* directly or indirectly to compete in (or accumulate points toward) a national championship or *International Event*, and does not involve the *Athlete* or other *Person* working in any capacity with *Protected Persons*.

An *Athlete* or other *Person* subject to a period of *Ineligibility* shall remain subject to *Testing* and any requirement by the UIM to provide whereabouts information.<sup>61</sup>

#### 10.14.2 Return to Training

As an exception to Article 10.14.1, an *Athlete* may return to train with a team or to use the facilities of a club or other member organization of the UIM's or other *Signatory's* member organization during the shorter of: (1) the last two months of the *Athlete's* period of *Ineligibility*, or (2) the last one-quarter of the period of *Ineligibility* imposed.<sup>62</sup>

#### 10.14.3 Violation of the Prohibition of Participation During *Ineligibility* or *Provisional Suspension*

Where an *Athlete* or other *Person* who has been declared *Ineligible* violates the prohibition against participation during *Ineligibility* described in Article 10.14.1, the results of such participation shall be *Disqualified* and a new period of *Ineligibility* equal in length to the original period of *Ineligibility* shall be added to the end of the original period of *Ineligibility*. The new period of *Ineligibility*, including a reprimand and no period of *Ineligibility*, may be adjusted based on the *Athlete* or other *Person's* degree of *Fault* and other circumstances of the case. The determination of whether an *Athlete* or other *Person* has violated the prohibition against participation, and whether an adjustment is appropriate, shall be made by the *Anti-Doping Organization* whose *Results Management* led to the imposition of the initial period of *Ineligibility*. This decision may be appealed under Article 13.

<sup>61</sup> [Comment to Article 10.14.1: For example, subject to Article 10.14.2 below, *Ineligible Athletes* cannot participate in a training camp, exhibition or practice organized by their National Authority or a club which is a member of that National Authority or which is funded by a governmental agency. Further, an *Ineligible Athlete* may not compete in a non-*Signatory* professional league (e.g., the National Hockey League, the National Basketball Association, etc.). Events organized by a non-*Signatory* International Event organization or a non-*Signatory* national-level Event organization without triggering the Consequences set forth in Article 10.14.3. The term "activity" also includes, for example, administrative activities, such as serving as an official, director, officer, employee, or volunteer of the organization described in this Article. *Ineligibility* imposed in one sport shall also be recognized by other sports (see Article 15.1, Automatic Binding Effect of Decisions). An *Athlete* or other *Person* serving a period of *Ineligibility* is prohibited from coaching or serving as an *Athlete Support Person* in any other capacity at any time during the period of *Ineligibility*, and doing so could also result in a violation of Article 2.10 by another *Athlete*. Any performance standard accomplished during a period of *Ineligibility* shall not be recognized by the UIM or its National Authorities for any purpose.]

<sup>62</sup> [Comment to Article 10.14.2: In many Team Sports and some individual sports (e.g., ski jumping and gymnastics), *Athletes* cannot effectively train on their own so as to be ready to compete at the end of the *Athlete's* period of *Ineligibility*. During the training period described in this Article, an *Ineligible Athlete* may not compete or engage in any activity described in Article 10.14.1 other than training.]

An *Athlete* or other *Person* who violates the prohibition against participation during a *Provisional Suspension* described in Article 10.14.1 shall receive no credit for any period of *Provisional Suspension* served and the results of such participation shall be *Disqualified*.

Where an *Athlete Support Person* or other *Person* assists a *Person* in violating the prohibition against participation during *Ineligibility* or a *Provisional Suspension*, the UIM shall impose sanctions for a violation of Article 2.9 for such assistance.

#### 10.14.4 Withholding of Financial Support during *Ineligibility*

In addition, for any anti-doping rule violation not involving a reduced sanction as described in Article 10.5 or 10.6, some or all sport-related financial support or other sport-related benefits received by such *Person* will be withheld by the UIM and its *National Authorities*.

#### 10.15 Automatic Publication of Sanction

A mandatory part of each sanction shall include automatic publication, as provided in Article 14.3.

### ARTICLE 11 CONSEQUENCES TO TEAMS

#### 11.1 Testing of Teams

Where one (1) member of a team (outside of *Team Sports*) has been notified of an anti-doping rule violation under Article 7 in connection with an *Event*, the ruling body for the *Event* shall conduct appropriate *Target Testing* of all members of the team during the *Event Period*.

#### 11.2 Consequences for Teams

- 11.2.1 An anti-doping rule violation committed by a member of a team in connection with an *In-Competition* test automatically leads to *Disqualification* of the result obtained by the team in that *Competition*, with all resulting *Consequences* for the team and its members, including forfeiture of any medals, points and prizes.
- 11.2.2 An anti-doping rule violation committed by a member of a team occurring during or in connection with an *Event* may lead to *Disqualification* of all of the results obtained by the team in that *Event* with all *Consequences* for the team and its members, including forfeiture of all medals, points and prizes, except as provided in Article 11.2.3.
- 11.2.3 Where an *Athlete* who is a member of a team committed an anti-doping rule violation during or in connection with one (1) *Competition* in an *Event*, if the other member(s) of the team establish(es) that he or she/they bear(s) *No Fault or Negligence* for that violation, the results of the team in any other *Competition(s)* in that *Event* shall not be *Disqualified* unless the results of the team in the *Competition(s)* other than the *Competition* in which the anti-doping rule violation occurred were likely to have been affected by the *Athlete's* anti-doping rule violation.

### ARTICLE 12 SANCTIONS BY the UIM AGAINST OTHER SPORTING BODIES

When the UIM becomes aware that a *National Authority* or any other sporting body over which it has authority has failed to comply with, implement, uphold, and enforce these Anti-Doping Rules within that organization's or body's area of competence, the UIM has the authority and may take the following additional disciplinary actions:

- 12.1** Exclude all, or some group of, members of that organization or body from specified future *Events* or all *Events* conducted within a specified period of time.
- 12.2** Take additional disciplinary actions with respect to that organization's or body's recognition, the eligibility of their members to participate in the UIM's activities, and/or fine that organization or body based on the following:
- 12.2.1** Four (4) or more violations of these Anti-Doping Rules (other than violations involving Article 2.4) are committed by *Athletes* or other *Persons* affiliated with that organization or body during a twelve (12) month period. In such event: (a) all or some group of members of that organization or body may be banned from participation in any the UIM activities for a period of up to two (2) years and/or (b) that organization or body may be fined in an amount up to 5'000 Euros.
- 12.2.2** Four (4) or more violations of these Anti-Doping Rules (other than violations involving Article 2.4) are committed in addition to the violations described in Article 12.2.1 by *Athletes* or other *Persons* affiliated with that organization or body during a twelve (12) month period. In such event, that organization or body may be suspended for a period of up to four (4) years.
- 12.2.3** More than one *Athlete* or other *Person* affiliated with that organization or body commits an anti-doping rule violation during an *International Event*. In such event, that organization or body may be fined in an amount up to 5'000 Euros.
- 12.2.4** That organization or body has failed to make diligent efforts to keep the UIM informed about an *Athlete's* whereabouts after receiving a request for that information from the UIM. In such event, that organization or body may be fined in an amount up to 1'000 Euros per *Athlete*, in addition to reimbursement of all of the the UIM costs incurred in *Testing* that organization's or body's *Athletes*.
- 12.3** Withhold some or all funding or other financial and non-financial support to that organization or body.
- 12.4** Oblige that organization or body to reimburse the UIM for all costs (including but not limited to laboratory fees, hearing expenses and travel) related to a violation of these Anti-Doping Rules committed by an *Athlete* or other *Person* affiliated with that organization or body.

## ARTICLE 13 RESULTS MANAGEMENT: APPEALS <sup>63</sup>

### 13.1 Decisions Subject to Appeal

Decisions made under the *Code* or these Anti-Doping Rules may be appealed as set forth below in Articles 13.2 through 13.7 or as otherwise provided in these Anti-Doping Rules, the *Code* or the *International Standards*. Such decisions shall remain in effect while under appeal unless the appellate body orders otherwise.

#### 13.1.1 Scope of Review Not Limited

<sup>63</sup> [Comment to Article 13: The object of the *Code* is to have anti-doping matters resolved through fair and transparent internal processes with a final appeal. Anti-doping decisions by Anti-Doping Organizations are made transparent in Article 14. Specified Persons and organizations, including WADA, are then given the opportunity to appeal those decisions. Note that the definition of interested Persons and organizations with a right to appeal under Article 13 does not include Athletes, or their federations, who might benefit from having another competitor Disqualified.]



The scope of review on appeal includes all issues relevant to the matter and is expressly not limited to the issues or scope of review before the initial decision maker. Any party to the appeal may submit evidence, legal arguments and claims that were not raised in the first instance hearing so long as they arise from the same cause of action or same general facts or circumstances raised or addressed in the first instance hearing.<sup>64</sup>

### 13.1.2 CAS Shall Not Defer to the Findings Being Appealed

In making its decision, CAS shall not give deference to the discretion exercised by the body whose decision is being appealed.<sup>65</sup>

### 13.1.3 WADA Not Required to Exhaust Internal Remedies

Where WADA has a right to appeal under Article 13 and no other party has appealed a final decision within the UIM's process, WADA may appeal such decision directly to CAS without having to exhaust other remedies in the UIM's process.<sup>66</sup>

## **13.2 Appeals from Decisions Regarding Anti-Doping Rule Violations, Consequences, Provisional Suspensions, Implementation of Decisions and Authority**

A decision that an anti-doping rule violation was committed, a decision imposing *Consequences* or not imposing *Consequences* for an anti-doping rule violation, or a decision that no anti-doping rule violation was committed; a decision that an anti-doping rule violation proceeding cannot go forward for procedural reasons (including, for example, prescription); a decision by WADA not to grant an exception to the six (6) months notice requirement for a retired *Athlete* to return to competition under Article 5.6.1; a decision by WADA assigning *Results Management* under Article 7.1 of the *Code*; a decision by the UIM not to bring forward an *Adverse Analytical Finding* or an *Atypical Finding* as an anti-doping rule violation, or a decision not to go forward with an anti-doping rule violation after an investigation in accordance with the *International Standard for Results Management*; a decision to impose, or lift, a *Provisional Suspension* as a result of a *Provisional Hearing*; the UIM's failure to comply with Article 7.4; a decision that the UIM lacks authority to rule on an alleged anti-doping rule violation or its *Consequences*; a decision to suspend, or not suspend, *Consequences* or to reinstate, or not reinstate, *Consequences* under Article 10.7.1; failure to comply with Articles 7.1.4 and 7.1.5 of the *Code*; failure to comply with Article 10.8.1; a decision under Article 10.14.3; a decision by the UIM not to implement another *Anti-Doping Organization's* decision under Article 15; and a decision under Article 27.3 of the *Code* may be appealed exclusively as provided in this Article 13.2.

### 13.2.1 Appeals Involving *International-Level Athletes* or *International Events*

In cases arising from participation in an *International Event* or in cases involving *International-Level Athletes*, the decision may be appealed exclusively to CAS.<sup>67</sup>

### 13.2.2 Appeals Involving Other *Athletes* or Other *Persons*

<sup>64</sup> [Comment to Article 13.1.1: The revised language is not intended to make a substantive change to the 2015 Code, but rather for clarification. For example, where an *Athlete* was charged in the first instance hearing only with *Tampering* but the same conduct could also constitute *Complicity*, an appealing party could pursue both *Tampering* and *Complicity* charges against the *Athlete* in the appeal.]

<sup>65</sup> [Comment to Article 13.1.2: CAS proceedings are *de novo*. Prior proceedings do not limit the evidence or carry weight in the hearing before CAS.]

<sup>66</sup> [Comment to Article 13.1.3: Where a decision has been rendered before the final stage of the UIM's process (for example, a first hearing) and no party elects to appeal that decision to the next level of the UIM's process (e.g., the Managing Board), then WADA may bypass the remaining steps in the UIM's internal process and appeal directly to CAS.]

<sup>67</sup> [Comment to Article 13.2.1: CAS decisions are final and binding except for any review required by law applicable to the annulment or enforcement of arbitral awards.]

In cases where Article 13.2.1 is not applicable, the decision may be appealed to an appellate body, in accordance with rules adopted by the *National Anti-Doping Organization* having authority over the *Athlete* or other *Person*.

The rules for such appeal shall respect the following principles: a timely hearing; a fair, impartial, *Operationally Independent* and *Institutionally Independent* hearing panel; the right to be represented by counsel at the *Person's* own expense; and a timely, written, reasoned decision.

If no such body as described above is in place and available at the time of the appeal, the decision may be appealed to CAS in accordance with the applicable procedural rules.

### 13.2.3 Persons Entitled to Appeal

#### 13.2.3.1 Appeals Involving *International-Level Athletes* or *International Events*

In cases under Article 13.2.1, the following parties shall have the right to appeal to CAS: (a) the *Athlete* or other *Person* who is the subject of the decision being appealed; (b) the other party to the case in which the decision was rendered; (c) the UIM; (d) the *National Anti-Doping Organization* of the *Person's* country of residence or countries where the *Person* is a national or license holder; (e) the International Olympic Committee or International Paralympic Committee, as applicable, where the decision may have an effect in relation to the Olympic Games or Paralympic Games, including decisions affecting eligibility for the Olympic Games or Paralympic Games; and (f) WADA.

#### 13.2.3.2 Appeals Involving Other *Athletes* or Other *Persons*

In cases under Article 13.2.2, the parties having the right to appeal to the national-level appeal body shall be as provided in the *National Anti-Doping Organization's* rules but, at a minimum, shall include the following parties: (a) the *Athlete* or other *Person* who is the subject of the decision being appealed; (b) the other party to the case in which the decision was rendered; (c) the UIM; (d) the *National Anti-Doping Organization* of the *Person's* country of residence or countries where the *Person* is a national or license holder; (e) the International Olympic Committee or International Paralympic Committee, as applicable, where the decision may have an effect in relation to the Olympic Games or Paralympic Games, including decisions affecting eligibility for the Olympic Games or Paralympic Games; and (f) WADA.

For cases under Article 13.2.2, WADA, the International Olympic Committee, the International Paralympic Committee, and the UIM shall also have the right to appeal to CAS with respect to the decision of the national-level appeal body.

Any party filing an appeal shall be entitled to assistance from CAS to obtain all relevant information from the *Anti-Doping Organization* whose decision is being appealed and the information shall be provided if CAS so directs.

#### 13.2.3.3 Duty to Notify

All parties to any CAS appeal must ensure that WADA and all other parties with a right to appeal have been given timely notice of the appeal.

#### 13.2.3.4 Appeal from Imposition of *Provisional Suspension*

Notwithstanding any other provision herein, the only *Person* who may appeal from the imposition of a *Provisional Suspension* is the *Athlete* or other *Person* upon whom the *Provisional Suspension* is imposed.

#### 13.2.3.5 Appeal from Decisions under Article 12

Decisions by the UIM pursuant to Article 12 may be appealed exclusively to CAS by the *National Authority* or other body.

#### 13.2.4 Cross Appeals and other Subsequent Appeals Allowed

Cross appeals and other subsequent appeals by any respondent named in cases brought to CAS under the *Code* are specifically permitted. Any party with a right to appeal under this Article 13 must file a cross appeal or subsequent appeal at the latest with the party's answer.<sup>68</sup>

### **13.3 Failure to Render a Timely Decision by the UIM**

Where, in a particular case, the UIM fails to render a decision with respect to whether an anti-doping rule violation was committed within a reasonable deadline set by WADA, WADA may elect to appeal directly to CAS as if the UIM had rendered a decision finding no anti-doping rule violation. If the CAS hearing panel determines that an anti-doping rule violation was committed and that WADA acted reasonably in electing to appeal directly to CAS, then WADA's costs and attorney fees in prosecuting the appeal shall be reimbursed to WADA by the UIM.<sup>69</sup>

### **13.4 Appeals Relating to TUEs**

TUE decisions may be appealed exclusively as provided in Article 4.4.

### **13.5 Notification of Appeal Decisions**

The UIM shall promptly provide the appeal decision to the *Athlete* or other *Person* and to the other *Anti-Doping Organizations* that would have been entitled to appeal under Article 13.2.3 as provided under Article 14.2.

### **13.6 Time for Filing Appeals<sup>70</sup>**

#### 13.6.1 Appeals to CAS

The time to file an appeal to CAS shall be twenty-one (21) days from the date of receipt of the decision by the appealing party. The above notwithstanding, the following shall apply in connection with appeals filed by a party entitled to appeal but which was not a party to the proceedings that led to the decision being appealed:

- (a) Within fifteen (15) days from the notice of the decision, such party/ies shall have the right to request a copy of the full case file pertaining to the decision from the *Anti-Doping Organization* that had *Results Management* authority;

<sup>68</sup> [Comment to Article 13.2.4: This provision is necessary because since 2011, CAS rules no longer permit an Athlete the right to cross appeal when an Anti-Doping Organization appeals a decision after the Athlete's time for appeal has expired. This provision permits a full hearing for all parties.]

<sup>69</sup> [Comment to Article 13.3: Given the different circumstances of each anti-doping rule violation investigation and Results Management, it is not feasible to establish a fixed time period for the UIM to render a decision before WADA may intervene by appealing directly to CAS. Before taking such action, however, WADA will consult with the UIM and give the UIM an opportunity to explain why it has not yet rendered a decision.]

<sup>70</sup> [Comment to Article 13.6: Whether governed by CAS rules or these Anti-Doping Rules, a party's deadline to appeal does not begin running until receipt of the decision. For that reason, there can be no expiration of a party's right to appeal if the party has not received the decision.]

- (b) If such a request is made within the fifteen (15) day period, then the party making such request shall have twenty-one (21) days from receipt of the file to file an appeal to CAS.

The above notwithstanding, the filing deadline for an appeal filed by WADA shall be the later of:

- (a) Twenty-one (21) days after the last day on which any other party having a right to appeal could have appealed, or
- (b) Twenty-one (21) days after WADA's receipt of the complete file relating to the decision.

### 13.6.2 Appeals Under Article 13.2.2

The time to file an appeal to an independent and impartial body in accordance with rules established by the *National Anti-Doping Organization* shall be indicated by the same rules of the *National Anti-Doping Organization*.

The above notwithstanding, the filing deadline for an appeal filed by WADA shall be the later of:

- (a) Twenty-one (21) days after the last day on which any other party having a right to appeal could have appealed, or
- (b) Twenty-one (21) days after WADA's receipt of the complete file relating to the decision.

## ARTICLE 14 CONFIDENTIALITY AND REPORTING

### 14.1 Information Concerning Adverse Analytical Findings, Atypical Findings, and Other Asserted Anti-Doping Rule Violations

#### 14.1.1 Notice of Anti-Doping Rule Violations to *Athletes* and other *Persons*

Notice to *Athletes* or other *Persons* of anti-doping rule violations asserted against them shall occur as provided under Articles 7 and 14.

If at any point during *Results Management* up until the anti-doping rule violation charge, the UIM decides not to move forward with a matter, it must notify the *Athlete* or other *Person*, (provided that the *Athlete* or other *Person* had been already informed of the ongoing *Results Management*).

Notice shall be delivered or emailed to *Athletes* or other *Persons*. If the notification takes place via the *Athlete* or other *Person's* National Authorities, the National Authorities shall confirm to the UIM that they have received the notification to the the UIM and also confirm and that the notification has been provided to the *Athlete* or other *Person*.

#### 14.1.2 Notice of Anti-Doping Rule Violations to *National Anti-Doping Organizations* and WADA

Notice of the assertion of an anti-doping rule violation to the *Athlete's* or other *Person's* *National Anti-Doping Organization* and WADA shall occur as provided under Articles 7 and 14, simultaneously with the notice to the *Athlete* or other *Person*.

If at any point during *Results Management* up until the anti-doping rule violation charge, the UIM decides not to move forward with a matter, it must give notice (with reasons) to the *Anti-Doping Organizations* with a right of appeal under Article 13.2.3.

Notice shall be delivered or emailed.

#### 14.1.3 Content of an Anti-Doping Rule Violation Notice

Notification of an anti-doping rule violation shall include: the *Athlete's* or other *Person's* name, country, sport and discipline within the sport, the *Athlete's* competitive level, whether the test was *In-Competition* or *Out-of-Competition*, the date of *Sample* collection, the analytical result reported by the laboratory, and other information as required by the *International Standard for Testing and Investigations* and *International Standard for Results Management*.

Notification of anti-doping rule violations other than under Article 2.1 shall also include the rule violated and the basis of the asserted violation.

#### 14.1.4 Status Reports

Except with respect to investigations which have not resulted in a notice of an anti-doping rule violation pursuant to Article 14.1.1, the *Athlete's* or other *Person's National Anti-Doping Organization* and WADA shall be regularly updated on the status and findings of any review or proceedings conducted pursuant to Article 7, 8 or 13 and shall be provided with a prompt written reasoned explanation or decision explaining the resolution of the matter.

#### 14.1.5 Confidentiality

The recipient organizations shall not disclose this information beyond those *Persons* with a need to know (which would include the appropriate personnel at the applicable *National Olympic Committee, National Authority*, until the UIM has made *Public Disclosure* as permitted by Article 14.3.

#### 14.1.6 Protection of Confidential Information by an Employee or Agent of the the UIM

The UIM shall ensure that information concerning *Adverse Analytical Findings, Atypical Findings*, and other asserted anti-doping rule violations remains confidential until such information is *Publicly Disclosed* in accordance with Article 14.3. The UIM shall ensure that its employees (whether permanent or otherwise), contractors, agents, consultants, and *Delegated Third Parties* are subject to fully enforceable contractual duty of confidentiality and to fully enforceable procedures for the investigation and disciplining of improper and/or unauthorized disclosure of such confidential information.

### **14.2 Notice of Anti-Doping Rule Violation or Violations of Ineligibility or Provisional Suspension Decisions and Request for Files**

14.2.1 Anti-doping rule violation decisions or decisions related to violations of *Ineligibility or Provisional Suspension* rendered pursuant to Article 7.6, 8.2, 10.5, 10.6, 10.7, 10.14.3 or 13.5 shall include the full reasons for the decision, including, if applicable, a justification for why the maximum potential sanction was not imposed. Where the decision is not in English or French, the UIM shall provide an English or French summary of the decision and the supporting reasons.

14.2.2 An *Anti-Doping Organization* having a right to appeal a decision received pursuant to Article 14.2.1 may, within fifteen (15) days of receipt, request a copy of the full case file pertaining to the decision.

### **14.3 Public Disclosure**

14.3.1 After notice has been provided to the *Athlete* or other *Person* in accordance with the *International Standard for Results Management*, and to the

applicable *Anti-Doping Organizations* in accordance with Article 14.1.2, the identity of any *Athlete* or other *Person* who is notified of a potential anti-doping rule violation, the *Prohibited Substance* or *Prohibited Method* and the nature of the violation involved, and whether the *Athlete* or other *Person* is subject to a *Provisional Suspension* may be *Publicly Disclosed* by the UIM.

- 14.3.2** No later than twenty (20) days after it has been determined in an appellate decision under Article 13.2.1 or 13.2.2, or such appeal has been waived, or a hearing in accordance with Article 8 has been waived, or the assertion of an anti-doping rule violation has not otherwise been timely challenged, or the matter has been resolved under Article 10.8, or a new period of *Ineligibility*, or reprimand, has been imposed under Article 10.14.3, the UIM must *Publicly Disclose* the disposition of the anti-doping matter, including the sport, the anti-doping rule violated, the name of the *Athlete* or other *Person* committing the violation, the *Prohibited Substance* or *Prohibited Method* involved (if any) and the *Consequences* imposed. the UIM must also *Publicly Disclose* within twenty (20) days the results of appellate decisions concerning anti-doping rule violations, including the information described above.<sup>71</sup>
- 14.3.3** After an anti-doping rule violation has been determined to have been committed in an appellate decision under Article 13.2.1 or 13.2.2 or such appeal has been waived, or in a hearing in accordance with Article 8 or where such hearing has been waived, or the assertion of an anti-doping rule violation has not otherwise been timely challenged, or the matter has been resolved under Article 10.8, the UIM may make public such determination or decision and may comment publicly on the matter.
- 14.3.4** In any case where it is determined, after a hearing or appeal, that the *Athlete* or other *Person* did not commit an anti-doping rule violation, the fact that the decision has been appealed may be *Publicly Disclosed*. However, the decision itself and the underlying facts may not be *Publicly Disclosed* except with the consent of the *Athlete* or other *Person* who is the subject of the decision. the UIM shall use reasonable efforts to obtain such consent, and if consent is obtained, shall *Publicly Disclose* the decision in its entirety or in such redacted form as the *Athlete* or other *Person* may approve.
- 14.3.5** Publication shall be accomplished at a minimum by placing the required information on the the UIM's website and leaving the information up for the longer of one (1) month or the duration of any period of *Ineligibility*. It will be removed immediately after the expiry of the indicated time periods.
- 14.3.6** Except as provided in Articles 14.3.1 and 14.3.3, no *Anti-Doping Organization*, *National Authority*, or *WADA*-accredited laboratory, or any official of any such body, shall publicly comment on the specific facts of any pending case (as opposed to general description of process and science) except in response to public comments attributed to, or based on information provided by, the *Athlete*, other *Person* or their entourage or other representatives.
- 14.3.7** The mandatory *Public Disclosure* required in Article 14.3.2 shall not be required where the *Athlete* or other *Person* who has been found to have committed an anti-doping rule violation is a *Minor*, *Protected Person* or *Recreational Athlete*. Any optional *Public Disclosure* in a case involving a *Minor*, *Protected Person* or *Recreational Athlete* shall be proportionate to the facts and circumstances of the case.

#### **14.4 Statistical Reporting**

<sup>71</sup> [Comment to Article 14.3.2: Where *Public Disclosure* as required by Article 14.3.2 would result in a breach of other applicable laws, the UIM's failure to make the *Public Disclosure* will not result in a determination of non-compliance with Code as set forth in Article 4.1 of the International Standard for the Protection of Privacy and Personal Information.]

The UIM shall, at least annually, publish publicly a general statistical report of its *Doping Control* activities, with a copy provided to WADA. The UIM may also publish reports showing the name of each *Athlete* tested and the date of each *Testing*.

#### **14.5 Doping Control Information Database and Monitoring of Compliance**

To enable WADA to perform its compliance monitoring role and to ensure the effective use of resources and sharing of applicable *Doping Control* information among *Anti-Doping Organizations*, the UIM shall report to WADA through ADAMS *Doping Control*-related information, including, in particular:

- (a) *Athlete Biological Passport* data for *International-Level Athletes* and *National-Level Athletes*,
- (b) Whereabouts information for *Athletes* including those in *Registered Testing Pools*,
- (c) *TUE* decisions, and
- (d) *Results Management* decisions,

as required under the applicable *International Standard(s)*.

**14.5.1** To facilitate coordinated test distribution planning, avoid unnecessary duplication in *Testing* by various *Anti-Doping Organizations*, and to ensure that *Athlete Biological Passport* profiles are updated, the UIM shall report all *In-Competition* and *Out-of-Competition* tests to WADA by entering the *Doping Control* forms into ADAMS in accordance with the requirements and timelines contained in the *International Standard* for *Testing* and *Investigations*.

**14.5.2** To facilitate WADA's oversight and appeal rights for *TUEs*, the UIM shall report all *TUE* applications, decisions and supporting documentation using ADAMS in accordance with the requirements and timelines contained in the *International Standard* for *Therapeutic Use Exemptions*.

**14.5.3** To facilitate WADA's oversight and appeal rights for *Results Management*, the UIM shall report the following information into ADAMS in accordance with the requirements and timelines outlined in the *International Standard* for *Results Management*: (a) notifications of anti-doping rule violations and related decisions for *Adverse Analytical Findings*; (b) notifications and related decisions for other anti-doping rule violations that are not *Adverse Analytical Findings*; (c) whereabouts failures; and (d) any decision imposing, lifting or reinstating a *Provisional Suspension*.

**14.5.4** The information described in this Article will be made accessible, where appropriate and in accordance with the applicable rules, to the *Athlete*, the *Athlete's National Anti-Doping Organization*, and any other *Anti-Doping Organizations* with *Testing* authority over the *Athlete*.

#### **14.6 Data Privacy**

**14.6.1** The UIM may collect, store, process or disclose personal information relating to *Athletes* and other *Persons* where necessary and appropriate to conduct its *Anti-Doping Activities* under the Code, the *International Standards* (including specifically the *International Standard* for the Protection of Privacy and Personal Information), these Anti-Doping Rules, and in compliance with applicable law.

**14.6.2** Without limiting the foregoing, the UIM shall:

- (a) Only process personal information in accordance with a valid legal ground;

- (b) Notify any *Participant* or *Person* subject to these Anti-Doping Rules, in a manner and form that complies with applicable laws and the *International Standard for the Protection of Privacy and Personal Information*, that their personal information may be processed by the UIM and other *Persons* for the purpose of the implementation of these Anti-Doping Rules;
- (c) Ensure that any third-party agents (including any *Delegated Third Party*) with whom the UIM shares the personal information of any *Participant* or *Person* is subject to appropriate technical and contractual controls to protect the confidentiality and privacy of such information.

## ARTICLE 15 IMPLEMENTATION OF DECISIONS

### 15.1 Automatic Binding Effect of Decisions by Signatory Anti-Doping Organizations

- 15.1.1** A decision of an anti-doping rule violation made by a *Signatory Anti-Doping Organization*, an appellate body (Article 13.2.2 of the *Code*) or CAS shall, after the parties to the proceeding are notified, automatically be binding beyond the parties to the proceeding upon the UIM and its *National Authorities*, as well as every *Signatory* in every sport with the effects described below:
- 15.1.1.1** A decision by any of the above-described bodies imposing a *Provisional Suspension* (after a *Provisional Hearing* has occurred or the *Athlete* or other *Person* has either accepted the *Provisional Suspension* or has waived the right to a *Provisional Hearing*, expedited hearing or expedited appeal offered in accordance with Article 7.4.3) automatically prohibits the *Athlete* or other *Person* from participation (as described in Article 10.14.1) in all sports within the authority of any *Signatory* during the *Provisional Suspension*.
  - 15.1.1.2** A decision by any of the above-described bodies imposing a period of *Ineligibility* (after a hearing has occurred or been waived) automatically prohibits the *Athlete* or other *Person* from participation (as described in Article 10.14.1) in all sports within the authority of any *Signatory* for the period of *Ineligibility*.
  - 15.1.1.3** A decision by any of the above-described bodies accepting an anti-doping rule violation automatically binds all *Signatories*.
  - 15.1.1.4** A decision by any of the above-described bodies to *Disqualify* results under Article 10.10 for a specified period automatically *Disqualifies* all results obtained within the authority of any *Signatory* during the specified period.
- 15.1.2** The UIM and its *National Authorities* shall recognize and implement a decision and its effects as required by Article 15.1.1, without any further action required, on the earlier of the date the UIM receives actual notice of the decision or the date the decision is placed into ADAMS.
- 15.1.3** A decision by an *Anti-Doping Organization*, a national appellate body or CAS to suspend, or lift, *Consequences* shall be binding upon the UIM and its *National Authorities* without any further action required, on the earlier of the date the UIM receives actual notice of the decision or the date the decision is placed into ADAMS.



- 15.1.4** Notwithstanding any provision in Article 15.1.1, however, a decision of an anti-doping rule violation by a *Major Event Organization* made in an expedited process during an *Event* shall not be binding on the UIM or its *National Authorities* unless the rules of the *Major Event Organization* provide the *Athlete* or other *Person* with an opportunity to an appeal under non-expedited procedures.<sup>72</sup>

### **15.2 Implementation of Other Decisions by Anti-Doping Organizations**

The UIM and its *National Authorities* may decide to implement other anti-doping decisions rendered by *Anti-Doping Organizations* not described in Article 15.1.1 above, such as a *Provisional Suspension* prior to a *Provisional Hearing* or acceptance by the *Athlete* or other *Person*.<sup>73</sup>

### **15.3 Implementation of Decisions by Body that is not a Signatory**

An anti-doping decision by a body that is not a *Signatory* to the *Code* shall be implemented by the UIM and its *National Authorities*, if the UIM finds that the decision purports to be within the authority of that body and the anti-doping rules of that body are otherwise consistent with the *Code*.<sup>74</sup>

## **ARTICLE 16 STATUTE OF LIMITATIONS**

No anti-doping rule violation proceeding may be commenced against an *Athlete* or other *Person* unless he or she has been notified of the anti-doping rule violation as provided in Article 7, or notification has been reasonably attempted, within ten (10) years from the date the violation is asserted to have occurred.

## **ARTICLE 17 EDUCATION**

The UIM shall plan, implement, evaluate and promote *Education* in line with the requirements of Article 18.2 of the *Code* and the *International Standard for Education*.

<sup>72</sup> [Comment to Article 15.1.4: By way of example, where the rules of the *Major Event Organization* give the *Athlete* or other *Person* the option of choosing an expedited CAS appeal or a CAS appeal under normal CAS procedure, the final decision or adjudication by the *Major Event Organization* is binding on other *Signatories* regardless of whether the *Athlete* or other *Person* chooses the expedited appeal option.]

<sup>73</sup> [Comment to Articles 15.1 and 15.2: *Anti-Doping Organization* decisions under Article 15.1 are implemented automatically by other *Signatories* without the requirement of any decision or further action on the *Signatories'* part. For example, when a *National Anti-Doping Organization* decides to *Provisionally Suspend* an *Athlete*, that decision is given automatic effect at the *International Federation* level. To be clear, the "decision" is the one made by the *National Anti-Doping Organization*, there is not a separate decision to be made by the *International Federation*. Thus, any claim by the *Athlete* that the *Provisional Suspension* was improperly imposed can only be asserted against the *National Anti-Doping Organization*. Implementation of *Anti-Doping Organizations'* decisions under Article 15.2 is subject to each *Signatory's* discretion. A *Signatory's* implementation of a decision under Article 15.1 or Article 15.2 is not appealable separately from any appeal of the underlying decision. The extent of recognition of TUE decisions of other *Anti-Doping Organizations* shall be determined by Article 4.4 and the *International Standard for Therapeutic Use Exemptions*.]

<sup>74</sup> [Comment to Article 15.3: Where the decision of a body that has not accepted the *Code* is in some respects *Code* compliant and in other respects not *Code* compliant, the UIM, other *Signatories* and *National Authorities* should attempt to apply the decision in harmony with the principles of the *Code*. For example, if in a process consistent with the *Code* a non-*Signatory* has found an *Athlete* to have committed an anti-doping rule violation on account of the presence of a *Prohibited Substance* in the *Athlete's* body but the period of ineligibility applied is shorter than the period provided for in the *Code*, then the UIM and all other *Signatories* should recognize the finding of an anti-doping rule violation and the *Athlete's* *National Anti-Doping Organization* should conduct a hearing consistent with Article 8 to determine whether the longer period of ineligibility provided in the *Code* should be imposed. The UIM or other *Signatory's* implementation of a decision, or their decision not to implement a decision under Article 15.3, is appealable under Article 13.]

The UIM may decide to request that *Athletes* complete *Educational* activities before and/or during their participation in select *Events* (e.g: Youth World Championships) as a condition of such participation. The list of *Events* for which *Athletes* will be required to complete *Educational* activities as a condition of participation will be published on the UIM's website.

Failure by the *Athlete* to complete *Educational* activities as requested by the UIM may result in the imposition of sanction under the UIM's disciplinary rules, unless the *Athlete* provides to the UIM a justification for such failure, which shall be assessed by the UIM on a case by case basis.

## ARTICLE 18 ADDITIONAL ROLES AND RESPONSIBILITIES OF NATIONAL AUTHORITIES

- 18.1** All *National Authorities* and their members shall comply with the *Code*, *International Standards*, and these Anti-Doping Rules. All *National Authorities* and other members shall include in their policies, rules and programs the provisions necessary to ensure that the UIM may enforce these Anti-Doping Rules (including carrying out *Testing*) directly in respect of *Athletes* (including *National-Level Athletes*) and other *Persons* under their anti-doping authority as specified in the Introduction to these Anti-Doping Rules (Section "Scope of these Anti-Doping Rules").
- 18.2** Each *National Authority* shall incorporate these Anti-Doping Rules either directly or by reference into its governing documents, constitution and/or rules as part of the rules of sport that bind their members so that the *National Authority* may enforce them itself directly in respect of *Athletes* (including *National-Level Athletes*) and other *Persons* under its anti-doping authority.
- 18.3** By adopting these Anti-Doping Rules, and incorporating them into their governing documents and rules of sport, *National Authorities* shall cooperate with and support the UIM in that function. They shall also recognize, abide by and implement the decisions made pursuant to these Anti-Doping Rules, including the decisions imposing sanctions on *Persons* under their authority.
- 18.4** All *National Authorities* shall take appropriate action to enforce compliance with the *Code*, *International Standards*, and these Anti-Doping Rules by *inter alia*:
- (i) conducting *Testing* only under the documented authority of the UIM and using their *National Anti-Doping Organization* or other *Sample* collection authority to collect *Samples* in compliance with the *International Standard for Testing and Investigations*;
  - (ii) recognizing the authority of the *National Anti-Doping Organization* in their country in accordance with Article 5.2.1 of the *Code* and assisting as appropriate with the *National Anti-Doping Organization's* implementation of the national *Testing* program for their sport;
  - (iii) analyzing all *Samples* collected using a WADA-accredited or WADA-approved laboratory in accordance with Article 6.1; and
  - (iv) ensuring that any national level anti-doping rule violation cases discovered by *National Authorities* are adjudicated by an *Operationally Independent* hearing panel in accordance with Article 8.1 and the *International Standard for Results Management*.
- 18.5** All *National Authorities* shall establish rules requiring all *Athletes* preparing for or participating in a *Competition* or activity authorized or organized by a *National Authority* or one of its member organizations, and all *Athlete Support Personnel* associated with such *Athletes*, to agree to be bound by these Anti-Doping Rules and to submit to the *Results Management* authority of the *Anti-Doping Organization* in conformity with the *Code* as a condition of such participation.

- 18.6** All *National Authorities* shall report any information suggesting or relating to an anti-doping rule violation to the UIM and to their *National Anti-Doping Organizations* and shall cooperate with investigations conducted by any *Anti-Doping Organization* with authority to conduct the investigation.
- 18.7** All *National Authorities* shall have disciplinary rules in place to prevent *Athlete Support Personnel* who are *Using Prohibited Substances* or *Prohibited Methods* without valid justification from providing support to *Athletes* under the authority of the UIM or the *National Authority*.
- 18.8** All *National Authorities* shall conduct anti-doping *Education* in coordination with their *National Anti-Doping Organizations*.

#### ARTICLE 19 ADDITIONAL Roles and responsibilities OF the UIM

- 19.1** In addition to the roles and responsibilities described in Article 20.3 of the *Code* for International Federations the UIM shall report to WADA on the UIM's compliance with the *Code* and the *International Standards* in accordance with Article 24.1.2 of the *Code*.
- 19.2** Subject to applicable law, and in accordance with Article 20.3.4 of the *Code*, all the UIM board members, directors, officers, employees and those of appointed *Delegated Third Parties* who are involved in any aspect of *Doping Control*, must sign a form provided by the UIM, agreeing to be bound by these Anti-Doping Rules as *Persons* in conformity with the *Code* for direct and intentional misconduct.
- 19.3** Subject to applicable law, and in accordance with Article 20.3.5 of the *Code*, any the UIM employee who is involved in *Doping Control* (other than authorized anti-doping *Education* or rehabilitation programs) must sign a statement provided by the UIM confirming that they are not *Provisionally Suspended* or serving a period of *Ineligibility* and have not been directly or intentionally engaged in conduct within the previous six (6) years which would have constituted a violation of anti-doping rules if *Code-compliant* rules had been applicable to them.

#### ARTICLE 20 ADDITIONAL ROLES AND RESPONSIBILITIES OF ATHLETES

- 20.1** To be knowledgeable of and comply with these Anti-Doping Rules.
- 20.2** To be available for *Sample* collection at all times.<sup>75</sup>
- 20.3** To take responsibility, in the context of anti-doping, for what they ingest and *Use*.
- 20.4** To inform medical personnel of their obligation not to *Use Prohibited Substances* and *Prohibited Methods* and to take responsibility to make sure that any medical treatment received does not violate these Anti-Doping Rules.
- 20.5** To disclose to the UIM and their *National Anti-Doping Organization* any decision by a non-*Signatory* finding that the *Athlete* committed an anti-doping rule violation within the previous ten (10) years.
- 20.6** To cooperate with *Anti-Doping Organizations* investigating anti-doping rule violations.

<sup>75</sup> [Comment to Article 20.2: With due regard to an Athlete's human rights and privacy, legitimate anti-doping considerations sometimes require *Sample* collection late at night or early in the morning. For example, it is known that some Athletes Use low doses of EPO during these hours so that it will be undetectable in the morning.]

Failure by any *Athlete* to cooperate in full with *Anti-Doping Organizations* investigating anti-doping rule violations may result in a charge of misconduct under the UIM's disciplinary rules.

- 20.7** To disclose the identity of their *Athlete Support Personnel* upon request by the UIM or a *National Authority*, or any other *Anti-Doping Organization* with authority over the *Athlete*.
- 20.8** Offensive conduct towards a *Doping Control* official or other *Person* involved in *Doping Control* by an *Athlete*, which does not otherwise constitute *Tampering*, may result in a charge of misconduct under the UIM's disciplinary rules.

#### **ARTICLE 21 ADDITIONAL ROLES AND RESPONSIBILITIES OF ATHLETE SUPPORT PERSONNEL**

- 21.1** To be knowledgeable of and comply with these Anti-Doping Rules.
- 21.2** To cooperate with the *Athlete Testing* program.
- 21.3** To use their influence on *Athlete* values and behavior to foster anti-doping attitudes.
- 21.4** To disclose to the UIM and their *National Anti-Doping Organization* any decision by a non-*Signatory* finding that they committed an anti-doping rule violation within the previous ten (10) years.
- 21.5** To cooperate with *Anti-Doping Organizations* investigating anti-doping rule violations.  
Failure by any *Athlete Support Personnel* to cooperate in full with *Anti-Doping Organizations* investigating anti-doping rule violations may result in a charge of misconduct under the UIM's disciplinary rules.
- 21.6** *Athlete Support Personnel* shall not *Use* or *Possess* any *Prohibited Substance* or *Prohibited Method* without valid justification.  
Any such *Use* or *Possession* may result in a charge of misconduct under the UIM's disciplinary rules.
- 21.7** Offensive conduct towards a *Doping Control* official or other *Person* involved in *Doping Control* by *Athlete Support Personnel*, which does not otherwise constitute *Tampering*, may result in a charge of misconduct under the UIM's disciplinary rules.

#### **ARTICLE 22 ADDITIONAL ROLES AND RESPONSIBILITIES OF OTHER PERSONS SUBJECT TO THESE ANTI-DOPING RULES**

- 22.1** To be knowledgeable of and comply with these Anti-Doping Rules.
- 22.2** To disclose to the UIM and their *National Anti-Doping Organization* any decision by a non-*Signatory* finding that they committed an anti-doping rule violation within the previous ten (10) years.
- 22.3** To cooperate with *Anti-Doping Organizations* investigating anti-doping rule violations.  
Failure by any other *Person* subject to these Anti-Doping Rules to cooperate in full with *Anti-Doping Organizations* investigating anti-doping rule violations may result in a charge of misconduct under the UIM's disciplinary rules.
- 22.4** Not to *Use* or *Possess* any *Prohibited Substance* or *Prohibited Method* without valid justification.

- 22.5 Offensive conduct towards a *Doping Control* official or other *Person* involved in *Doping Control* by a *Person*, which does not otherwise constitute *Tampering*, may result in a charge of misconduct under the UIM's disciplinary rules.

#### ARTICLE 23 INTERPRETATION OF THE CODE

- 23.1 The official text of the *Code* shall be maintained by *WADA* and shall be published in English and French. In the event of any conflict between the English and French versions, the English version shall prevail.
- 23.2 The comments annotating various provisions of the *Code* shall be used to interpret the *Code*.
- 23.3 The *Code* shall be interpreted as an independent and autonomous text and not by reference to the existing law or statutes of the *Signatories* or governments.
- 23.4 The headings used for the various Parts and Articles of the *Code* are for convenience only and shall not be deemed part of the substance of the *Code* or to affect in any way the language of the provisions to which they refer.
- 23.5 Where the term "days" is used in the *Code* or an *International Standard*, it shall mean calendar days unless otherwise specified.
- 23.6 The *Code* shall not apply retroactively to matters pending before the date the *Code* is accepted by a *Signatory* and implemented in its rules. However, pre-*Code* anti-doping rule violations would continue to count as "First violations" or "Second violations" for purposes of determining sanctions under Article 10 for subsequent post-*Code* violations.
- 23.7 The Purpose, Scope and Organization of the World Anti-Doping Program and the *Code* and Appendix 1, Definitions, and Appendix 2, Examples of the Application of Article 10, shall be considered integral parts of the *Code*.

#### ARTICLE 24 FINAL PROVISIONS

- 24.1 Where the term "days" is used in these Anti-Doping Rules, it shall mean calendar days unless otherwise specified.
- 24.2 These Anti-Doping Rules shall be interpreted as an independent and autonomous text and not by reference to existing law or statutes.
- 24.3 These Anti-Doping Rules have been adopted pursuant to the applicable provisions of the *Code* and the *International Standards* and shall be interpreted in a manner that is consistent with applicable provisions of the *Code* and the *International Standards*. The *Code* and the *International Standards* shall be considered integral parts of these Anti-Doping Rules and shall prevail in case of conflict.
- 24.4 The Introduction and Appendix 1 shall be considered integral parts of these Anti-Doping Rules.
- 24.5 The comments annotating various provisions of these Anti-Doping Rules shall be used to interpret these Anti-Doping Rules.
- 24.6 These Anti-Doping Rules entered into force on 1 January 2022 (the "Effective Date"). They repeal previous versions of the UIM's Anti-Doping Rules.
- 24.7 These Anti-Doping Rules shall not apply retroactively to matters pending before the Effective Date. However:

- 24.7.1** Anti-doping rule violations taking place prior to the Effective Date count as "first violations" or "second violations" for purposes of determining sanctions under Article 10 for violations taking place after the Effective Date.
- 24.7.2** Any anti-doping rule violation case which is pending as of the Effective Date and any anti-doping rule violation case brought after the Effective Date based on an anti-doping rule violation which occurred prior to the Effective Date, shall be governed by the substantive anti-doping rules in effect at the time the alleged anti-doping rule violation occurred, and not by the substantive anti-doping rules set out in these Anti-Doping Rules, unless the panel hearing the case determines the principle of "lex mitior" appropriately applies under the circumstances of the case. For these purposes, the retrospective periods in which prior violations can be considered for purposes of multiple violations under Article 10.9.4 and the statute of limitations set forth in Article 16 are procedural rules, not substantive rules, and should be applied retroactively along with all of the other procedural rules in these Anti-Doping Rules (provided, however, that Article 16 shall only be applied retroactively if the statute of limitation period has not already expired by the Effective Date).
- 24.7.3** Any Article 2.4 whereabouts failure (whether a filing failure or a missed test, as those terms are defined in the *International Standard for Results Management*) prior to the Effective Date shall be carried forward and may be relied upon, prior to expiry, in accordance with the *International Standard for Results Management*, but it shall be deemed to have expired twelve (12) months after it occurred.
- 24.7.4** With respect to cases where a final decision finding an anti-doping rule violation has been rendered prior to the Effective Date, but the *Athlete* or other *Person* is still serving the period of *Ineligibility* as of the Effective Date, the *Athlete* or other *Person* may apply to the UIM or other *Anti-Doping Organization* which had *Results Management* responsibility for the anti-doping rule violation to consider a reduction in the period of *Ineligibility* in light of these Anti-Doping Rules. Such application must be made before the period of *Ineligibility* has expired. The decision rendered may be appealed pursuant to Article 13.2. These Anti-Doping Rules shall have no application to any case where a final decision finding an anti-doping rule violation has been rendered and the period of *Ineligibility* has expired.
- 24.7.5** For purposes of assessing the period of *Ineligibility* for a second violation under Article 10.9.1, where the sanction for the first violation was determined based on rules in force prior to the Effective Date, the period of *Ineligibility* which would have been assessed for that first violation had these Anti-Doping Rules been applicable, shall be applied.<sup>76</sup>
- 24.7.6** Changes to the *Prohibited List* and *Technical Documents* relating to substances or methods on the *Prohibited List* shall not, unless they specifically provide otherwise, be applied retroactively. As an exception, however, when a *Prohibited Substance* or *Prohibited Method* has been removed from the *Prohibited List*, an *Athlete* or other *Person* currently serving a period of *Ineligibility* on account of the formerly *Prohibited Substance* or *Prohibited Method* may apply to the UIM or other *Anti-Doping Organization* which had *Results Management* responsibility for the anti-doping rule violation to consider a reduction in the period of *Ineligibility* in light of the removal of the substance or method from the *Prohibited List*.

<sup>76</sup> [Comment to Article 24.7.5: Other than the situation described in Article 24.7.5, where a final decision finding an anti-doping rule violation has been rendered prior to the Effective Date and the period of *Ineligibility* imposed has been completely served, these Anti-Doping Rules may not be used to re-characterize the prior violation.]

## APPENDIX 1 DEFINITIONS<sup>77</sup>

**ADAMS:** The Anti-Doping Administration and Management System is a Web-based database management tool for data entry, storage, sharing, and reporting designed to assist stakeholders and WADA in their anti-doping operations in conjunction with data protection legislation.

**Administration:** Providing, supplying, supervising, facilitating, or otherwise participating in the *Use* or *Attempted Use* by another *Person* of a *Prohibited Substance* or *Prohibited Method*. However, this definition shall not include the actions of bona fide medical personnel involving a *Prohibited Substance* or *Prohibited Method Used* for genuine and legal therapeutic purposes or other acceptable justification and shall not include actions involving *Prohibited Substances* which are not prohibited in *Out-of-Competition Testing* unless the circumstances as a whole demonstrate that such *Prohibited Substances* are not intended for genuine and legal therapeutic purposes or are intended to enhance sport performance.

**Adverse Analytical Finding:** A report from a WADA-accredited laboratory or other WADA-approved laboratory that, consistent with the *International Standard for Laboratories*, establishes in a *Sample* the presence of a *Prohibited Substance* or its *Metabolites* or *Markers* or evidence of the *Use* of a *Prohibited Method*.

**Adverse Passport Finding:** A report identified as an *Adverse Passport Finding* as described in the applicable *International Standards*.

**Aggravating Circumstances:** Circumstances involving, or actions by, an *Athlete* or other *Person* which may justify the imposition of a period of *Ineligibility* greater than the standard sanction. Such circumstances and actions shall include, but are not limited to: the *Athlete* or other *Person Used* or *Possessed* multiple *Prohibited Substances* or *Prohibited Methods, Used* or *Possessed* a *Prohibited Substance* or *Prohibited Method* on multiple occasions or committed multiple other anti-doping rule violations; a normal individual would be likely to enjoy the performance-enhancing effects of the anti-doping rule violation(s) beyond the otherwise applicable period of *Ineligibility*; the *Athlete* or *Person* engaged in deceptive or obstructive conduct to avoid the detection or adjudication of an anti-doping rule violation; or the *Athlete* or other *Person* engaged in *Tampering* during *Results Management*. For the avoidance of doubt, the examples of circumstances and conduct described herein are not exclusive and other similar circumstances or conduct may also justify the imposition of a longer period of *Ineligibility*.

**Anti-Doping Activities:** Anti-doping *Education* and information, test distribution planning, maintenance of a *Registered Testing Pool*, managing *Athlete Biological Passports*, conducting *Testing*, organizing analysis of *Samples*, gathering of intelligence and conduct of investigations, processing of *TUE* applications, *Results Management*, monitoring and enforcing compliance with any *Consequences* imposed, and all other activities related to anti-doping to be carried out by or on behalf of an *Anti-Doping Organization*, as set out in the *Code* and/or the *International Standards*.

**Anti-Doping Organization:** WADA or a *Signatory* that is responsible for adopting rules for initiating, implementing or enforcing any part of the *Doping Control* process. This includes, for example, the International Olympic Committee, the International Paralympic Committee, other *Major Event Organizations* that conduct *Testing* at their *Events*, International Federations, and *National Anti-Doping Organizations*.

**Athlete:** Any *Person* who competes in sport at the international level (as defined by each International Federation) or the national level (as defined by each *National Anti-Doping Organization*). An *Anti-Doping Organization* has discretion to apply anti-doping rules to an *Athlete* who is neither an *International-Level Athlete* nor a *National-Level Athlete*, and thus to bring them within the definition of "Athlete". In relation to *Athletes* who are neither *International-Level* nor *National-Level Athletes*, an *Anti-Doping Organization* may elect to: conduct limited *Testing* or no *Testing* at all; analyze *Samples* for less than the full menu of *Prohibited Substances*; require limited or no whereabouts information; or not require advance *TUEs*. However, if an Article 2.1, 2.3 or 2.5 anti-doping rule violation is committed by any *Athlete* over whom an *Anti-Doping Organization* has elected to exercise its authority to test and who competes below the international or national level, then the *Consequences* set forth in the *Code* must be applied. For purposes of Article 2.8 and Article 2.9 and for purposes of anti-doping information and *Education*, any *Person* who participates in sport under the authority of any *Signatory*, government, or other sports organization accepting the *Code* is an *Athlete*.<sup>78</sup>

<sup>77</sup> [Comment to Definitions: Defined terms shall include their plural and possessive forms, as well as those terms used as other parts of speech.]

<sup>78</sup> [Comment to Athlete: Individuals who participate in sport may fall in one of five categories: 1) International-Level Athlete, 2) National-Level Athlete, 3) individuals who are not International- or National-Level Athletes but over whom the International Federation or National Anti-Doping Organization has chosen to exercise authority, 4) Recreational Athlete, and 5) individuals over whom no International Federation or National Anti-Doping Organization has, or has chosen to, exercise authority. All International- and National-Level Athletes are subject to the anti-doping rules of the Code, with the precise definitions of international and national level sport to be set forth in the anti-doping rules of the International Federations and National Anti-Doping Organizations.]

**Athlete Biological Passport:** The program and methods of gathering and collating data as described in the *International Standard for Testing and Investigations* and *International Standard for Laboratories*.

**Athlete Support Personnel:** Any coach, trainer, manager, agent, team staff, official, medical, paramedical personnel, parent or any other *Person* working with, treating or assisting an *Athlete* participating in or preparing for sports *Competition*.

**Attempt:** Purposely engaging in conduct that constitutes a substantial step in a course of conduct planned to culminate in the commission of an anti-doping rule violation. Provided, however, there shall be no anti-doping rule violation based solely on an *Attempt* to commit a violation if the *Person* renounces the *Attempt* prior to it being discovered by a third party not involved in the *Attempt*.

**Atypical Finding:** A report from a WADA-accredited laboratory or other WADA-approved laboratory which requires further investigation as provided by the *International Standard for Laboratories* or related *Technical Documents* prior to the determination of an *Adverse Analytical Finding*.

**Atypical Passport Finding:** A report described as an *Atypical Passport Finding* as described in the applicable *International Standards*.

CAS: The Court of Arbitration for Sport.

Code: The World Anti-Doping Code.

**Competition:** A single race, match, game or singular sport contest. For example, a basketball game or the finals of the Olympic 100-meter race in athletics. For stage races and other sport contests where prizes are awarded on a daily or other interim basis the distinction between a *Competition* and an *Event* will be as provided in the rules of the UIM.

**Consequences of Anti-Doping Rule Violations ("Consequences"):** An *Athlete's* or other *Person's* violation of an anti-doping rule may result in one or more of the following: (a) Disqualification means the *Athlete's* results in a particular *Competition* or *Event* are invalidated, with all resulting *Consequences* including forfeiture of any medals, points and prizes; (b) Ineligibility means the *Athlete* or other *Person* is barred on account of an anti-doping rule violation for a specified period of time from participating in any *Competition* or other activity or funding as provided in Article 10.14; (c) Provisional Suspension means the *Athlete* or other *Person* is barred temporarily from participating in any *Competition* or activity prior to the final decision at a hearing conducted under Article 8; (d) Financial Consequences means a financial sanction imposed for an anti-doping rule violation or to recover costs associated with an anti-doping rule violation; and (e) Public Disclosure means the dissemination or distribution of information to the general public or *Persons* beyond those *Persons* entitled to earlier notification in accordance with Article 14. .

**Contaminated Product:** A product that contains a *Prohibited Substance* that is not disclosed on the product label or in information available in a reasonable Internet search.

**Decision Limit:** The value of the result for a threshold substance in a *Sample*, above which an *Adverse Analytical Finding* shall be reported, as defined in the *International Standard for Laboratories*.

**Delegated Third Party:** Any *Person* to which the UIM delegates any aspect of *Doping Control* or anti-doping *Education* programs including, but not limited to, third parties or other *Anti-Doping Organizations* that conduct *Sample* collection or other *Doping Control* services or anti-doping *Educational* programs for the UIM, or individuals serving as independent contractors who perform *Doping Control* services for the UIM (e.g., non-employee *Doping Control* officers or chaperones). This definition does not include CAS.

**Disqualification:** See *Consequences of Anti-Doping Rule Violations* above.

**Doping Control:** All steps and processes from test distribution planning through to ultimate disposition of any appeal and the enforcement of *Consequences*, including all steps and processes in between, including but not limited to *Testing*, investigations, whereabouts, *TUEs*, *Sample* collection and handling, laboratory analysis, *Results Management*, and investigations or proceedings relating to violations of Article 10.14 (Status During *Ineligibility* or *Provisional Suspension*).

**Education:** The process of learning to instill values and develop behaviors that foster and protect the spirit of sport, and to prevent intentional and unintentional doping.

**Event:** A series of individual *Competitions* conducted together under one ruling body (e.g., the Olympic Games, World Championships of an International Federation, or Pan American Games).



**Event Period:** The time between the beginning and end of an *Event*, as established by the ruling body of the *Event* (e.g. also specified in the *Advance Programme*).

**Event Venues:** Those venues so designated by the ruling body for the *Event*.

**Fault:** *Fault* is any breach of duty or any lack of care appropriate to a particular situation. Factors to be taken into consideration in assessing an *Athlete's* or other *Person's* degree of *Fault* include, for example, the *Athlete's* or other *Person's* experience, whether the *Athlete* or other *Person* is a *Protected Person*, special considerations such as impairment, the degree of risk that should have been perceived by the *Athlete* and the level of care and investigation exercised by the *Athlete* in relation to what should have been the perceived level of risk. In assessing the *Athlete's* or other *Person's* degree of *Fault*, the circumstances considered must be specific and relevant to explain the *Athlete's* or other *Person's* departure from the expected standard of behavior. Thus, for example, the fact that an *Athlete* would lose the opportunity to earn large sums of money during a period of *Ineligibility*, or the fact that the *Athlete* only has a short time left in a career, or the timing of the sporting calendar, would not be relevant factors to be considered in reducing the period of *Ineligibility* under Article 10.6.1 or 10.6.2.<sup>79</sup>

**Financial Consequences:** See *Consequences of Anti-Doping Rule Violations* above.

**In-Competition:** The period commencing at 11:59 p.m. on the day before a *Competition* in which the *Athlete* is scheduled to participate through the end of such *Competition* and the *Sample* collection process related to such *Competition*.

**Independent Observer Program:** A team of observers and/or auditors, under the supervision of WADA, who observe and provide guidance on the *Doping Control* process prior to or during certain *Events* and report on their observations as part of WADA's compliance monitoring program.

**Individual Sport:** Any sport that is not a *Team Sport*.

**Ineligibility:** See *Consequences of Anti-Doping Rule Violations* above.

**Institutional Independence:** Hearing panels on appeal shall be fully independent institutionally from the *Anti-Doping Organization* responsible for *Results Management*. They must therefore not in any way be administered by, connected or subject to the *Anti-Doping Organization* responsible for *Results Management*.

**International Event:** An *Event* or *Competition* where the International Olympic Committee, the International Paralympic Committee, an International Federation, a *Major Event Organization*, or another international sport organization is the ruling body for the *Event* or appoints the technical officials for the *Event*.

**International-Level Athlete:** *Athletes* who compete in sport at the international level, as defined by each International Federation, consistent with the *International Standard for Testing and Investigations*. For the sport of powerboating which includes Aquabike and Motosurfs disciplines, *International-Level Athletes* are defined as set out in the Scope section of the Introduction to these Anti-Doping Rules.<sup>81</sup>

**International Standard:** A standard adopted by WADA in support of the *Code*. Compliance with an *International Standard* (as opposed to another alternative standard, practice or procedure) shall be sufficient to conclude that the procedures addressed by the *International Standard* were performed properly. *International Standards* shall include any *Technical Documents* issued pursuant to the *International Standard*.

**Major Event Organizations:** The continental associations of *National Olympic Committees* and other international multi-sport organizations that function as the ruling body for any continental, regional or other *International Event*.

**Marker:** A compound, group of compounds or biological variable(s) that indicates the *Use of a Prohibited Substance or Prohibited Method*.

<sup>79</sup> [Comment to *Fault*: The criteria for assessing an *Athlete's* degree of *Fault* is the same under all *Articles* where *Fault* is to be considered. However, under Article 10.6.2, no reduction of sanction is appropriate unless, when the degree of *Fault* is assessed, the conclusion is that No Significant *Fault* or *Negligence* on the part of the *Athlete* or other *Person* was involved.]

<sup>81</sup> [Comment to *International-Level Athlete*: Consistent with the *International Standard for Testing and Investigations*, the UIM is free to determine the criteria it will use to classify *Athletes* as *International-Level Athletes*, e.g., by ranking, by participation in particular *International Events*, by type of license, etc. However, it must publish those criteria in clear and concise form, so that *Athletes* are able to ascertain quickly and easily when they will become classified as *International-Level Athletes*. For example, if the criteria include participation in certain *International Events*, then the *International Federation* must publish a list of those *International Events*.]

**Metabolite:** Any substance produced by a biotransformation process.

**Minimum Reporting Level:** The estimated concentration of a *Prohibited Substance* or its *Metabolite(s)* or *Marker(s)* in a *Sample* below which WADA-accredited laboratories should not report that *Sample* as an *Adverse Analytical Finding*.

**Minor:** A natural *Person* who has not reached the age of eighteen (18) years.

**National Anti-Doping Organization:** The entity(ies) designated by each country as possessing the primary authority and responsibility to adopt and implement anti-doping rules, direct the collection of *Samples*, the management of test results, and the conduct of hearings at the national level. If this designation has not been made by the competent public authority(ies), the entity shall be the country's *National Olympic Committee* or its designee.

**National Event:** A sport *Event* or *Competition* involving *International-* or *National-Level Athletes* that is not an *International Event*.

**National Authority:** A national or regional entity which is a member of or is recognized by the UIM as the entity governing the UIM's sport in that nation or region.

**National-Level Athlete:** *Athletes* who compete in sport at the national level, as defined by each *National Anti-Doping Organization*, consistent with the *International Standard for Testing and Investigations*.

**National Olympic Committee:** The organization recognized by the International Olympic Committee. The term *National Olympic Committee* shall also include the National Sport Confederation in those countries where the National Sport Confederation assumes typical *National Olympic Committee* responsibilities in the anti-doping area.

**No Fault or Negligence:** The *Athlete* or other *Person's* establishing that he or she did not know or suspect, and could not reasonably have known or suspected even with the exercise of utmost caution, that he or she had *Used* or been administered the *Prohibited Substance* or *Prohibited Method* or otherwise violated an anti-doping rule. Except in the case of a *Protected Person* or *Recreational Athlete*, for any violation of Article 2.1, the *Athlete* must also establish how the *Prohibited Substance* entered the *Athlete's* system.

**No Significant Fault or Negligence:** The *Athlete* or other *Person's* establishing that any *Fault* or *Negligence*, when viewed in the totality of the circumstances and taking into account the criteria for *No Fault or Negligence*, was not significant in relationship to the anti-doping rule violation. Except in the case of a *Protected Person* or *Recreational Athlete*, for any violation of Article 2.1, the *Athlete* must also establish how the *Prohibited Substance* entered the *Athlete's* system.

**Operational Independence:** This means that (1) board members, staff members, commission members, consultants and officials of the *Anti-Doping Organization* with responsibility for *Results Management* or its affiliates (e.g., member federation or confederation), as well as any *Person* involved in the investigation and pre-adjudication of the matter cannot be appointed as members and/or clerks (to the extent that such clerk is involved in the deliberation process and/or drafting of any decision) of hearing panels of that *Anti-Doping Organization* with responsibility for *Results Management* and (2) hearing panels shall be in a position to conduct the hearing and decision-making process without interference from the *Anti-Doping Organization* or any third party. The objective is to ensure that members of the hearing panel or individuals otherwise involved in the decision of the hearing panel, are not involved in the investigation of, or decisions to proceed with, the case.

**Out-of-Competition:** Any period which is not *In-Competition*.

**Participant:** Any *Athlete* or *Athlete Support Person*.

**Person:** A natural *Person* or an organization or other entity.

**Possession:** The actual, physical *Possession*, or the constructive *Possession* (which shall be found only if the *Person* has exclusive control or intends to exercise control over the *Prohibited Substance* or *Prohibited Method* or the premises in which a *Prohibited Substance* or *Prohibited Method* exists); provided, however, that if the *Person* does not have exclusive control over the *Prohibited Substance* or *Prohibited Method* or the premises in which a *Prohibited Substance* or *Prohibited Method* exists, constructive *Possession* shall only be found if the *Person* knew about the presence of the *Prohibited Substance* or *Prohibited Method* and intended to exercise control over it. Provided, however, there shall be no anti-doping rule violation based solely on *Possession* if, prior to receiving notification of any kind that the *Person* has committed an anti-doping rule violation, the *Person* has taken concrete action demonstrating that the *Person* never intended to have *Possession* and has renounced *Possession* by explicitly declaring it to an *Anti-Doping Organization*. Notwithstanding anything to the contrary in this definition, the

purchase (including by any electronic or other means) of a *Prohibited Substance* or *Prohibited Method* constitutes *Possession* by the *Person* who makes the purchase.<sup>82</sup>

**Prohibited List:** The List identifying the *Prohibited Substances* and *Prohibited Methods*.

**Prohibited Method:** Any method so described on the *Prohibited List*.

**Prohibited Substance:** Any substance, or class of substances, so described on the *Prohibited List*.

**Protected Person:** An *Athlete* or other natural *Person* who at the time of the anti-doping rule violation: (i) has not reached the age of sixteen (16) years; (ii) has not reached the age of eighteen (18) years and is not included in any *Registered Testing Pool* and has never competed in any *International Event* in an open category; or (iii) for reasons other than age has been determined to lack legal capacity under applicable national legislation.<sup>83</sup>

**Provisional Hearing:** For purposes of Article 7.4.3, an expedited abbreviated hearing occurring prior to a hearing under Article 8 that provides the *Athlete* with notice and an opportunity to be heard in either written or oral form.<sup>84</sup>

**Provisional Suspension:** See *Consequences of Anti-Doping Rule Violations* above.

**Publicly Disclose:** See *Consequences of Anti-Doping Rule Violations* above.

**Recreational Athlete:** A natural *Person* who is so defined by the relevant *National Anti-Doping Organization*; provided, however, the term shall not include any *Person* who, within the five (5) years prior to committing any anti-doping rule violation, has been an *International-Level Athlete* (as defined by each International Federation consistent with the *International Standard for Testing and Investigations*) or *National-Level Athlete* (as defined by each *National Anti-Doping Organization* consistent with the *International Standard for Testing and Investigations*), has represented any country in an *International Event* in an open category or has been included within any *Registered Testing Pool* or other whereabouts information pool maintained by any International Federation or *National Anti-Doping Organization*.<sup>85</sup>

**Regional Anti-Doping Organization:** A regional entity designated by member countries to coordinate and manage delegated areas of their national anti-doping programs, which may include the adoption and implementation of anti-doping rules, the planning and collection of *Samples*, the management of results, the review of *TUEs*, the conduct of hearings, and the conduct of *Educational* programs at a regional level.

**Registered Testing Pool:** The pool of highest-priority *Athletes* established separately at the international level by International Federations and at the national level by *National Anti-Doping Organizations*, who are subject to focused *In-Competition* and *Out-of-Competition Testing* as part of that International Federation's or *National Anti-Doping Organization's* test distribution plan and therefore are required to provide whereabouts information as provided in Article 5.5 and the *International Standard for Testing and Investigations*.

**Results Management:** The process encompassing the timeframe between notification as per Article 5 of the *International Standard for Results Management*, or in certain cases (e.g., *Atypical Finding*, *Athlete Biological Passport*, whereabouts failure), such pre-notification steps expressly provided for in Article 5 of the *International Standard for Results Management*, through the charge until the final resolution of the matter, including the end of the hearing process at first instance or on appeal (if an appeal was lodged).

**Sample or Specimen:** Any biological material collected for the purposes of *Doping Control*.<sup>86</sup>

<sup>82</sup> [Comment to Possession: Under this definition, anabolic steroids found in an Athlete's car would constitute a violation unless the Athlete establishes that someone else used the car; in that event, the UIM must establish that, even though the Athlete did not have exclusive control over the car, the Athlete knew about the anabolic steroids and intended to have control over them. Similarly, in the example of anabolic steroids found in a home medicine cabinet under the joint control of an Athlete and spouse, the UIM must establish that the Athlete knew the anabolic steroids were in the cabinet and that the Athlete intended to exercise control over them. The act of purchasing a Prohibited Substance alone constitutes Possession, even where, for example, the product does not arrive, is received by someone else, or is sent to a third party address.]

<sup>83</sup> [Comment to Protected Person: The Code treats Protected Persons differently than other Athletes or Persons in certain circumstances based on the understanding that, below a certain age or intellectual capacity, an Athlete or other Person may not possess the mental capacity to understand and appreciate the prohibitions against conduct contained in the Code. This would include, for example, a Paralympic Athlete with a documented lack of legal capacity due to an intellectual impairment. The term "open category" is meant to exclude competition that is limited to junior or age group categories.]

<sup>84</sup> [Comment to Provisional Hearing: A Provisional Hearing is only a preliminary proceeding which may not involve a full review of the facts of the case. Following a Provisional Hearing, the Athlete remains entitled to a subsequent full hearing on the merits of the case. By contrast, an "expedited hearing", as that term is used in Article 7.4.3, is a full hearing on the merits conducted on an expedited time schedule.]

<sup>85</sup> [Comment to Recreational Athlete: The term "open category" is meant to exclude competition that is limited to junior or age group categories.]

<sup>86</sup> [Comment to Sample or Specimen: It has sometimes been claimed that the collection of blood Samples violates the tenets of certain religious or cultural groups. It has been determined that there is no basis for any such claim.]

**Signatories:** Those entities accepting the *Code* and agreeing to implement the *Code*, as provided in Article 23 of the *Code*.

**Specified Method:** See Article 4.2.2.

**Specified Substance:** See Article 4.2.2.

**Strict Liability:** The rule which provides that under Article 2.1 and Article 2.2, it is not necessary that intent, *Fault*, *Negligence*, or knowing *Use* on the *Athlete's* part be demonstrated by the *Anti-Doping Organization* in order to establish an anti-doping rule violation.

**Substance of Abuse:** See Article 4.2.3.

**Substantial Assistance:** For purposes of Article 10.7.1, a *Person* providing *Substantial Assistance* must: (1) fully disclose in a signed written statement or recorded interview all information he or she possesses in relation to anti-doping rule violations or other proceeding described in Article 10.7.1.1, and (2) fully cooperate with the investigation and adjudication of any case or matter related to that information, including, for example, presenting testimony at a hearing if requested to do so by an *Anti-Doping Organization* or hearing panel. Further, the information provided must be credible and must comprise an important part of any case or proceeding which is initiated or, if no case or proceeding is initiated, must have provided a sufficient basis on which a case or proceeding could have been brought.

**Tampering:** Intentional conduct which subverts the *Doping Control* process but which would not otherwise be included in the definition of *Prohibited Methods*. *Tampering* shall include, without limitation, offering or accepting a bribe to perform or fail to perform an act, preventing the collection of a *Sample*, affecting or making impossible the analysis of a *Sample*, falsifying documents submitted to an *Anti-Doping Organization* or *TUE* committee or hearing panel, procuring false testimony from witnesses, committing any other fraudulent act upon the *Anti-Doping Organization* or hearing body to affect *Results Management* or the imposition of *Consequences*, and any other similar intentional interference or *Attempted* interference with any aspect of *Doping Control*.<sup>87</sup>

**Target Testing:** Selection of specific *Athletes* for *Testing* based on criteria set forth in the *International Standard for Testing and Investigations*.

**Team Sport:** A sport in which the substitution of players is permitted during a *Competition*.

**Technical Document:** A document adopted and published by WADA from time to time containing mandatory technical requirements on specific anti-doping topics as set forth in an *International Standard*.

**Testing:** The parts of the *Doping Control* process involving test distribution planning, *Sample* collection, *Sample* handling, and *Sample* transport to the laboratory.

**Testing Pool:** The tier below the *Registered Testing Pool* which includes *Athletes* from whom some whereabouts information is required in order to locate and *Test* the *Athlete Out-of-Competition*.

**Therapeutic Use Exemption (TUE):** A *Therapeutic Use Exemption* allows an *Athlete* with a medical condition to *Use* a *Prohibited Substance* or *Prohibited Method*, but only if the conditions set out in Article 4.4 and the *International Standard for Therapeutic Use Exemptions* are met.

**Trafficking:** Selling, giving, transporting, sending, delivering or distributing (or *Possessing* for any such purpose) a *Prohibited Substance* or *Prohibited Method* (either physically or by any electronic or other means) by an *Athlete*, *Athlete Support Person* or any other *Person* subject to the authority of an *Anti-Doping Organization* to any third party; provided, however, this definition shall not include the actions of bona fide medical personnel involving a *Prohibited Substance Used* for genuine and legal therapeutic purposes or other acceptable justification, and shall not include actions involving *Prohibited Substances* which are not prohibited in *Out-of-Competition Testing* unless the circumstances as a whole demonstrate such *Prohibited Substances* are not intended for genuine and legal therapeutic purposes or are intended to enhance sport performance.

<sup>87</sup> [Comment to *Tampering*: For example, this Article would prohibit altering identification numbers on a *Doping Control* form during *Testing*, breaking the B bottle at the time of B *Sample* analysis, altering a *Sample* by the addition of a foreign substance, or intimidating or attempting to intimidate a potential witness or a witness who has provided testimony or information in the *Doping Control* process. *Tampering* includes misconduct which occurs during the *Results Management* and hearing process. See Article 10.9.3.3. However, actions taken as part of a *Person's* legitimate defense to an anti-doping rule violation charge shall not be considered *Tampering*. *Offensive* conduct towards a *Doping Control* official or other *Person* involved in *Doping Control* which does not otherwise constitute *Tampering* shall be addressed in the disciplinary rules of sport organizations.]

**UNESCO Convention:** The International Convention against Doping in Sport adopted by the 33<sup>rd</sup> session of the UNESCO General Conference on 19 October 2005 including any and all amendments adopted by the States Parties to the Convention and the Conference of Parties to the International Convention against Doping in Sport.

**Use:** The utilization, application, ingestion, injection or consumption by any means whatsoever of any *Prohibited Substance* or *Prohibited Method*.

**WADA:** The World Anti-Doping Agency.

**Without Prejudice Agreement:** For purposes of Articles 10.7.1.1 and 10.8.2, a written agreement between an *Anti-Doping Organization* and an *Athlete* or other *Person* that allows the *Athlete* or other *Person* to provide information to the *Anti-Doping Organization* in a defined time-limited setting with the understanding that, if an agreement for *Substantial Assistance* or a case resolution agreement is not finalized, the information provided by the *Athlete* or other *Person* in this particular setting may not be used by the *Anti-Doping Organization* against the *Athlete* or other *Person* in any *Results Management* proceeding under the *Code*, and that the information provided by the *Anti-Doping Organization* in this particular setting may not be used by the *Athlete* or other *Person* against the *Anti-Doping Organization* in any *Results Management* proceeding under the *Code*. Such an agreement shall not preclude the *Anti-Doping Organization*, *Athlete* or other *Person* from using any information or evidence gathered from any source other than during the specific time-limited setting described in the agreement.



1922 – 2022

# ENVIRONMENTAL CODE 2022



The UIM Environmental Code  
has been acknowledged by RINA and allowed the UIM to be nominated  
"2011 GREEN ASSOCIATION"

## TABLE OF CONTENTS

<b>ENVIRONMENTAL CODE .....</b>	<b>466</b>
<i>TABLE OF CONTENTS.....</i>	<i>467</i>
1. <i>GENERAL PRINCIPLES .....</i>	<i>468</i>
2. <i>UIM ENVIRONMENTAL WORKING GROUP (EWG).....</i>	<i>469</i>
3. <i>ENVIRONMENTAL STEWARD .....</i>	<i>470</i>
4. <i>UIM ENVIRONMENTAL DELEGATE.....</i>	<i>470</i>
5. <i>NOISE.....</i>	<i>471</i>
6. <i>FUEL.....</i>	<i>472</i>
7. <i>PROTECTION OF GROUND AND WATER.....</i>	<i>472</i>
8. <i>CLEANING OF POWERBOATS .....</i>	<i>472</i>
9. <i>ACTION TO BE TAKEN BY DRIVERS / PARTICIPANTS.....</i>	<i>472</i>
10. <i>REQUIREMENTS TO ENCOURAGE ENVIRONMENTAL BEHAVIOUR BY THE SPECTATORS.....</i>	<i>473</i>
11. <i>ACTION TO BE TAKEN BY INTERNATIONAL ORGANIZERS .....</i>	<i>473</i>
12. <i>RECOMMENDATIONSTOALLSEA/LAKE/RIVER USERS.....</i>	<i>476</i>
13. <i>UIM ENVIRONMENTAL AWARD.....</i>	<i>476</i>
14. <i>UIM TRIANNUAL WORLD CIRCUMNAVIGATION RACE .....</i>	<i>476</i>
15. <i>GREEN LOGO.....</i>	<i>476</i>

## **1.GENERAL PRINCIPLES**

### **DEFINITION**

#### **1.1**

Powerboat activities fall into three main categories: *Competition*, recreation and transport. This *Code* includes competitive activities for members running the UIM racing classes included the UIM rulebooks for offshore, circuit, pleasure navigation and aqua bike. The *Code* is a working document until fully adopted by the UIM General Assembly.

#### **1.2**

Competitive powerboat racing events are a major constituent of the International and national sporting calendars, attracting an increasing audience and producing significant economic effects. It is a sport which, like most other sports, and human activities in general, creates an impact on the environment.

#### **1.3**

Power boating activities in general, as a means of transport or for recreation, continues to increase, and therefore must also be looked at from an environmental point of view. The UIM will do its best to transfer best practices from competitive power boating to these other areas.

#### **1.4**

The UIM considers it to be of major importance to develop a coherent environmental policy, taking into account the legislative and regulatory requirements of each country.

#### **1.5**

The UIM will seek to establish at all times the highest environmental standards during the organization of powerboat events at all levels and will promote environmental consciousness among all powerboat racers. The UIM will do so in close co-operation with the *National* Authorities and all involved stakeholders.

#### **1.6**

The UIM environment policy, as defined in this *Code*, is based on mutual respect of the needs of the environment and of reasonable practices of powerboat sports and powerboat driving in general.

#### **1.7**

The UIM seeks close co-operation with International authorities and organizations in order to ensure that there are sufficient facilities for powerboat activities in environmentally acceptable conditions and encourages its member nations to do so at national, regional and local level.

#### **1.8**

All national federations affiliated to the UIM shall do their best efforts in order to give proper prominence to environmental matters and to the principles of the UIM Environmental *Code*.



## 1.9

According to the above general principles, this *Code* prescribes regulations and recommendations to improve the relationship between Power boating competitions and the environment.

These regulations and recommendations refer in particular to:

- a) Climate emissions in cooperation with guidelines given from the UNEP and minimize to reach zero emissions in the future.
- b) Noise, fuel and protection of the water
- c) Behaviour of the spectators, organizers, officers and race participants in order to maintain the highest possible standards worldwide

## 1.10

The UIM encourage all national authorities to issue guidelines in line with the above and taking into considerations o regional and national legislations.

## 1.11

The non respect of a requirement of the UIM *Environmental Code* by an organizer or a racer or the *Person* responsible for his racing team is liable to a fine, a *Disqualification* from the *Event* or a suspension. Moreover, the *Participant/Driver/pilot* may be liable for the damages caused by his non-respect of the environmental provisions.

## **2.UIM ENVIRONMENTAL WORKING GROUP (EWG)**

### **2.1 ROLE AND RESPONSIBILITIES**

#### **Role**

The Environmental Group role is to advise the UIM on what policy should be adopted in terms of environmental protection, alternative energies and support for sustainable development and, through its members, support the UIM programs and activities in this field.

#### **Responsibilities**

- Raise awareness on environment, alternative energies and sustainable development among UIM *National Authorities* and UIM stakeholders
- Disseminate knowledge and ensure know-how transfer in the above areas
- Promote environmental responsibility in the planning and staging of UIM events
- Ensure compliance of UIM affiliated members with the *Environmental Code*
- Promote the creation of an Environmental Working Group within *National Federations*
- Organize environmental seminars and establish a high profile network of correspondents
- Prepare an annual environmental report
- Presentation of the EWG work and findings at the UIM Council and General Assembly
- Advice the national environmental working groups on how to tackle environmental issues
- Liaise with external institutions such as public authorities, environmental organizations and other sporting bodies

## **3. ENVIRONMENTAL STEWARD**

### **3.1 ROLE AND RESPONSIBILITIES**

#### **Role**

At the UIM titled events there should be an official called the Environmental Steward who shall deal only with environmental aspects and who must have successfully completed a seminar organized by the UIM Environmental Working Group (hereafter EWG).

#### **Responsibilities**

- Ensure that the UIM Environmental *Code* is respected.
- Have access to all information concerning the *Event*, and must be able to give prior, during and after the *Event*, recommendations to the OOD on all aspects of the *Event* which may have potential environmental consequences.
- Draw up in an appropriate manner a report on the basis of a check-list and send it to the UIM Secretariat. A copy should also be handed to the OOD and the UIM Environmental Delegate if present at the *Event*. In case of a first non-respect of this point, the Environmental Steward will receive a warning from the UIM or its national federation. In case of a second offence, the UIM may pronounce against the Environmental Steward a suspension of up to 12 months.
- Instruct officials during national seminars for the various disciplines, as well as for racers and organizers.
- In case of non-respect or violation of the provisions mentioned in the present *Code*, he must immediately first inform the OOD.

## **4. UIM ENVIRONMENTAL DELEGATE**

### **4.1 ROLE AND RESPONSIBILITIES**

#### **Role**

The UIM Environmental Delegate is a member of and is nominated by the EWG. There is a need to find the premises for the Environmental Delegate to be able to operate. The UIM Commissioner will handle the environmental observations on title championships and include the observations in their report.

#### **Responsibilities**

- Observe and verify the application of the Environmental *Code*.
- Inform the OOD of any violation of the Environmental *Code* in order to pronounce sanctions relative to the infraction.
- Identify areas of "good practice" and make recommendations or proposals of modifications of the Environmental *Code*.
- Perform inspections of the racecourse and its facilities at any time before, during or after the *Event*.
- Prepare a report summing up all important aspects of the *Event* that relate to the environment.
- Any serious failure of the Environmental Steward towards the obligations and due diligence mentioned in article 2 of the present *Code* noticed by the UIM Environmental Delegate will be examined and, in case of need, sanctioned by the EWG with withdrawal of the Environmental Steward's license for a period of up to 12 months.

An educational program is mandatory for the UIM environmental delegates.

## **5. NOISE**

### **5.1 INTRODUCTION**

Concerns regarding noise at powerboat events are not limited to the machines themselves. In addition to the expected engine noise, organizers and environmental stewards must be aware of the magnitude of sound from public address systems, crowds and other sources associated with an *Event*. Minimizing excessive noise associated with powerboat activity and taking public reaction to noise in consideration is the responsibility of all concerned: *Drivers*, clubs, organizers and officials.

### **5.2 NOISE OF POWERBOATS**

Sound is a measurable phenomenon created when a source, such as a powerboat engine, causes the air to vibrate. In contrast, noise is an individual interpretation of the impact of that sound. A sound enjoyed by one may be annoying or even harmful to another. Powerboats with high sound levels are almost always considered noisy. The Environmental Steward must understand the difference between the two and how sound is quantified. The decibel (dB) is the unit used to express sound pressure levels and they are measured on several scales. Powerboat sound is tested on the "A" weighted scale and is expressed as dB (A). Sound pressure levels increase at a logarithmic rate (very quickly) while the human ear interprets that increase more slowly. As a consequence, each time the number of identical sound sources is doubled (as with many powerboats at the starting line), the sound pressure level measurement is increased by only 3 dB(A). Sound levels decrease as the distance from the source increases. A doubling of the distance from the source to the ear causes a loss of 6 dB (A). Temperature, geography, elevation, humidity and the frequency of the sound waves also contribute to the rate of energy loss. Such things as foliage, uneven ground and sea and large obstacles, such as walls, cars or embankments will reflect sound and affect sound levels in the immediate area.

The UIM recommends:

- a) To avoid all unnecessary running of engines.
- b) To reduce as much as possible the sound levels in all disciplines and ensure that all applicable regulations are strictly respected.
- c) The UIM shall always promote research on the question of sound level in relation to powerboat sports.
- d) The UIM will aim to set regulations stipulating the maximum permitted noise levels for each class. Noise levels should be set for the different classes in cooperation with the different commissions. When the limit has been set the regulations shall be monitored and sanctioned strictly.

### **5.3 SOUND LEVEL MEASUREMENTS**

Environmental Stewards and *Event* organizers should be familiar with local ordinances governing both *Event* and powerboat sound levels. For details of specific sound levels for each discipline refer to the relevant rules. The UIM noise control method and sound levels are also recommended for national or club events.

### **5.4 PUBLIC ADDRESS SYSTEM**

- a) Separate public-address systems for *Drivers'* paddock and the public areas/enclosures are preferable and should never produce a higher sound than the hearing damage threshold level 83 dB(A) when measured in a public area and should also not exceed 3 dB(A) above the background and sea sound levels when measured at the nearest dwelling house.
- b) Position of loud-speakers: slanted towards the ground and directed towards the centre of the course.
- c) Maintain sound level as low as possible. The whole system must be ready and tested 30 minutes before the start of the practice. The sound system often causes more annoyance outside the track area than the actual event. Make arrangements with the people in charge of the sound system to reduce the sound volume between races/practice sessions.

## **6.FUEL**

It is recommended that regular unleaded fuel, available at the service stations, or other cleaner fuels provided by the organizers, without additives, except oil for two stroke engines, is used.

The use of alternative energies such as bio fuels, hydrogen or electricity, as long as they are not more noxious for the environment, must be encouraged for all disciplines in conformity with the relevant technical regulations. For the purposes of protecting the environment, provisions regarding fuel storage mentioned in the relevant rules must be respected.

Transition implementation – When a Class has more than 50% of the entries using EPA engines at a World Championship then the non EPA engines are phased out.

For details, refer to the technical rules of the various sporting disciplines.

## **7.PROTECTION OF GROUND AND WATER**

- Measures must be taken to prevent leaks of fuel, oil, cleaning, degreasing, cooling and brake fluids, etc. into the ground and water or vapour into the air.
- Containers/facilities to recover rubbish, oils, chemicals, detergents, etc. must be provided.
- The Use of an environmental mat, (or other effective device) protecting the ground and water, is compulsory to be used where servicing of machines is permitted by the organizer, amongst others in the paddock and repair areas. Any infraction of this rule will be reported to the OOD who will fine the Driver/pilot responsible a maximum of USD 1000 or any other amount mentioned in the regulation or appendix of the discipline.
- Provision must be made for the treatment of spillage and the disposal of contaminated material by the organizers.
- It is strictly forbidden to empty onto the ground and water waste fluids from vehicles or boats located in the Drivers' paddock and the campsite. Waste water may only be disposed of at the circuit a proper facility to this effect. Any infraction to this rule will be reported to the OOD who will fine the Driver/pilot responsible a maximum of USD 500. Other sanctions may be pronounced by the OOD or the UIM Commissioner.
- Do not leave on the spot sustainable evidence of any Event, club or boating activity.

### **7.1 ENVIRONMENTAL MAT**

The Environmental Mat is compulsory for all disciplines. It must be composed of an absorbent part and an impermeable part. Its Use will be compulsory everywhere where work on powerboats is allowed by the organizers.

## **8.CLEANING OF POWERBOATS**

- Cleaning of engine and motor parts, where permitted by the regulations, must only be carried out at places with cleaning facilities.
- Only certified non toxic solvent, without the addition of chemical products (for example detergent), is permitted when cleaning the boats.
- The cleaning area must be built with a non-porous surface and a proper drain with an oil-divider to prevent pollution of the ground and water. Any infraction of this rule will be reported to the Officer of the Day (OOD) who will fine the Driver/pilot responsible a maximum of USD 500. – or any other amount mentioned in the regulation or appendix of the discipline.

## **9.ACTION TO BE TAKEN BY DRIVERS / PARTICIPANTS**

- Each Driver is responsible for the waste generated by his team during the event.
- Where organizers provide the necessary containers for waste they must be used as directed.
- Waste must be retained by the team until the approved facilities provided by organizers can be used.

- d) Where refuelling or servicing of a powerboat is being undertaken at events, Driver/participants must provide and Use an environment mat to protect the ground and water. This environmental mat must also be compulsory when an electrical generator or any other device with a thermal engine is used by the driver/pilot or the team. These mats must be removed by the driver/pilots/competitors after Use.
- e) Any infringement by the Participant or Driver/pilot (who is responsible for his team) of the UIM regulations can result in a fine, Disqualification from the event or suspension, and may also result in the participant or driver/pilot being liable for any costs of rectification.

## **10.REQUIREMENTS TO ENCOURAGE ENVIRONMENTAL BEHAVIOUR BY THE SPECTATORS**

Visitors to a powerboat circuit, track, event or gathering can play an important role in keeping the environment clean and undamaged. Here are some suggestions:

- a) In co-operation with the local authorities, select the routes to and from circuits, tracks, etc., which will cause as little annoyance as possible for the surrounding areas.
- b) Provide clear signs to circuits, tracks and venues.
- c) Avoid parking on vulnerable places (verges, green lanes).
- d) Avoid parking in long grass.
- e) Promote the Use of public transportation in publications and promotional releases i.e. web or other forums.
- f) Avoid too high concentrations of people in order to preserve vulnerable places i.e. wildlife and bird reservation.
- g) Provide sufficient sanitary facilities and safe cleaning and deposit systems.
- h) Inform the spectators about responsible behaviour on the site.
- i) Specify in contracts with catering firms a requirement to sell drinks and food packaged in recyclable, reusable or biodegradable material, and to provide and maintain sufficient waste containers. Promote cooperation with caterers that have high standards on ethical and ecological food.
- j) Manage the events in such a way that only footsteps remain on the soil.

## **11.ACTION TO BE TAKEN BY INTERNATIONAL ORGANIZERS**

Promote environmental behaviour among all Persons involved within the organization and promote environmentally friendly work within the secretariat and the Administration to save paper and energy.

Venues creating participants more than 50 and/or spectators more 20 000, shall make a more comprehensive written environmental plan including the following points:

1. Use of resources (energy, chemicals and materials)
2. Impact on environment and climate emissions
3. Carbon offsetting all activities related to events from
4. Recycling and reduction of waste
5. Travelling and accommodation for spectators and guests
6. Birds, animals and wildlife
7. Visual environment

Any organizer of an event under the authority of the UIM is subject to its regulation and jurisdiction. Any clearly established infraction or inobservance of the prescriptions and obligations for the organizers are subject to the penalties laid down in the present Environmental Code or in other UIM disciplinary procedures.

Infringement of Article 11 will be reported to the UIM ExCO who can fine the organizer a minimum of USD 1000 or any other amount mentioned in the regulation or appendix of the specific discipline.

## 11.1 ENVIRONMENTAL PROVISIONS

Make arrangements to prevent pollution of the ground and water in the Drivers' dry/wet pits and surrounding areas. Look after the protection of verges along the access roads, parking, and fencing off (tape) vulnerable areas. The facilities for practice, racing, gatherings and the surroundings must be protected as much as possible from pollution and annoyance. Having regard to the expected number of spectators, provide and maintain sufficient and clean sanitation, with proper provisions for waste and water.

Measures must also be taken to prevent:

- Leakage of fuel, oil, cleaning, degreasing, cooling and brake fluids, etc. into the ground and water or vapour into the air.
- Waste from participants, their teams, spectators and selling points not being collected in waste-bins or containers and being left on the ground and water at the site.
- Sanitary facilities being connected improperly to the sewerage.
- Waste collected and removed in an illegal way.
- UIM sound levels for powerboats during practice or Event being exceeded.
- Inordinate sound levels at tourist gatherings.
- The maximum number of events and/or practicing time being exceeded.

## 11.2 LOGBOOK / CHECK-LIST

It is important for every motor sport Event organizer to maintain a "logbook" in which is written all activities and measures that have been taken, what meetings have taken place and with whom, what permissions have been sought and those that have been granted relative to the Use and maintenance of the facilities for powerboat sport or other event. If permission is only given for Use of the facilities for a certain period of time, the exact time when it is in Use must also be noted. Together with the logbook it is useful to Use a check-list for the management of the facilities, to stimulate an environment friendly behaviour by the spectators and an environment friendly Use of the facilities during events. This check-list must include at least the following points:

- An assessment of the environmental impact of the event on the circuit and its surroundings, having regard to the number of competitors and the expected number of spectators.
- Cleaning area with high-pressure cleaners for powerboats.
- Distribution of waste bags to participants and their teams.
- Containers for used oil, cooling fluid or any other liquid.
- Containers for spectators' general litter.
- Sanitary facilities.
- Judicious positioning of loud speakers.
- Provision of adequate and appropriate direction signs to the event.
- Provision of containers or waste bags in the pits of the mechanics' area and collection of the contents during and after the event.

## 11.3 PUBLICITY/ADVERTISING

- The UIM suggest aggressive Use of the Web and media instead of prints/posters on paper.
- Do not attach posters to trees, in country areas and/or protected urban-sites nor in places and areas which are not appropriate.
- Place billboards only after having obtained permission from the owner of the property.
- Take local and governmental regulations into account when placing billboards.
- Do not distribute leaflets/pamphlets under windscreen wipers of cars, on powerboats, nor to spectators (do not allow others to do so during your event).

#### 11.4 DRIVER PADDOCK / SERVICE AREAS / TIME CONTROL AREAS

- a) Present every participant on arrival with a rubbish bag and instructions.
- b) Provide sufficient containers for the rubbish bags and set recycling stations accessible to the public and participating teams.
- c) Ensure that there are enough containers with fixed funnels to collect used oil.
- d) Provide recognizable containers for oil filters and cleaning rags; collect separately.
- e) Provide and maintain sufficient and clean sanitation, with proper provisions for waste and water, for both men and women.
- f) If cleaning of powerboats is allowed, a special wash area designed to ensure the ground and water is not polluted must be provided in accordance with the rules of the discipline concerned.
- g) The Use of an environmental mat is compulsory when a generator or any other device with a thermal engine is used.

#### 11.5 AFTER THE EVENT

- a) Signposts, billboards and posters must be removed after the event.
- b) Waste left behind on the site and the surroundings must be cleaned up and removed as soon as possible.
- c) Clear away and dispose of any broken branches or shrubs.
- d) Clear away tape, buoys and rope/weights around the track.
- e) Arrange for separate removal of oil-containers, cleaning rags, oil filters and waste-containers.
- f) The infraction or inobservance by the organizer of obligations mentioned in the present Environmental Code are subject to sanctions laid down in this Code and can result in a fine or suspension of approval to organize UIM events. The organizer will also be liable for any costs of rectification.

#### 11.6 GENERAL REGULATIONS FOR THE MANAGEMENT OF VENUES

- a) Keep up the maintenance of the venue and take care that it is kept clean and tidy at all times.
- b) Cordon off sensitive areas.
- c) Appoint a member of the Organizing Board to be in charge of all environmental aspects and maintain the environment logbook.
- d) Ensure proper disposal of waste from sanitary facilities.
- e) Take all necessary care when making changes/adjustments to the site and consult the appropriate authorities.
- f) When locating the starting areas, take acoustic impacts into account.
- g) Never Use building waste, rubble, etc. for the construction of noise barriers, etc.
- h) In case of the Use of materials from outside, have them checked by the appropriate authorities to ensure that they are not polluted.
- i) Following every Event and at regular intervals, make an evaluation of the impact of the Event on the environment; make a report of it in the logbook; and make recommendations to correct any shortcomings and errors.

## **12.RECOMMENDATIONSTOALLSEA/LAKE/RIVER USERS**

### **12.1 INTRODUCTION**

We must voluntarily moderate and add a greater degree of responsibility to our natural desire for individual mobility. We should try to achieve results on the basis of freedom of thought and movement, and exploit every opportunity to combine the pleasure of Powerboating more effectively with ecological and economic needs.

### **12.2 DRIVER CONDUCT**

- a) Individual power boaters should develop driving habits to ensure full integration with other types of sea, lake and river users.
- b) Ride safely and avoid aggressive driving.
- c) Save petrol and reduce pollution by avoiding unnecessary idling of engines.
- d) Limit noise pollution
- e) Noise annoyance. Use exhaust system (towards/into water) which minimize noise and keep audio systems at a low level.
- f) Protect wildlife and its natural habitat
- g) Ensure that your used oil, batteries and other recyclable items are properly recycled or collected.
- h) Remember that our seas/lakes/ivers belong to the overall community.

## **13.UIM ENVIRONMENTAL AWARD**

In order to encourage a greater awareness of environmental concerns, the UIM has created an Environmental Award to reward a significant contribution to the protection of the environment. This Award may be given each year according to the following rules:

- a) By "year", the EWG understands that the year taken into consideration to award the prize starts on 1 January and ends on 30 September. The candidatures must arrive at the UIM Secretariat by the 5 October at the latest.
- b) This distinction is granted for rewarding individuals, clubs, organizers, manufacturers or other organizations that have made a significant contribution or done something important to enhance environmental awareness in the field of Power boating
- c) Candidatures for the Environmental Award will be submitted to the UIM by October 5<sup>th</sup> at the latest. The EWG may also propose a candidate.
- d) The candidatures received will be examined by the UIM Environment Group prior to submitting them to the ExCo. The recipient can be invited to the UIM GA to receive his/her (their) distinction.
- e) These nominations should be submitted, along with a description of the occurrence qualifying for the Award, to the UIM Secretariat within the set deadline

## **14.UIM TRIANNUAL WORLD CIRCUMNAVIGATION RACE**

Every three years the UIM may organize a world circumnavigation race. The race shall be performed on alternative energy and sustainability principles.

## **15.GREEN LOGO**



The UIM have approved this Green Logo



The Rules and/or regulations set forth herein are designed to provide for the orderly conduct of competitive events and to establish minimum acceptable requirements for such events. These rules shall govern the condition of all UIM events. By participating in the events, all UIM members are deemed to have complied with these rules. No express or implied warranty of safety shall result from publications of, or compliance with these rules and/or regulations. They are intended as a guide for the conduct of the sport and are in no way a guarantee against injury or death to participants, spectators, or others.

The rules are published on the UIM Website: [www.uim.sport](http://www.uim.sport)

© (2022) Copyright by UIM - Union Internationale Motonautique. All rights reserved. No part of this document/publication may be reproduced, distributed, or transmitted in any form or by any means without the prior written consent of the UIM, except for the non-commercial use within the scope of authority of the UIM and its affiliated members



UIM

[uim@uim.sport](mailto:uim@uim.sport)